

η^+

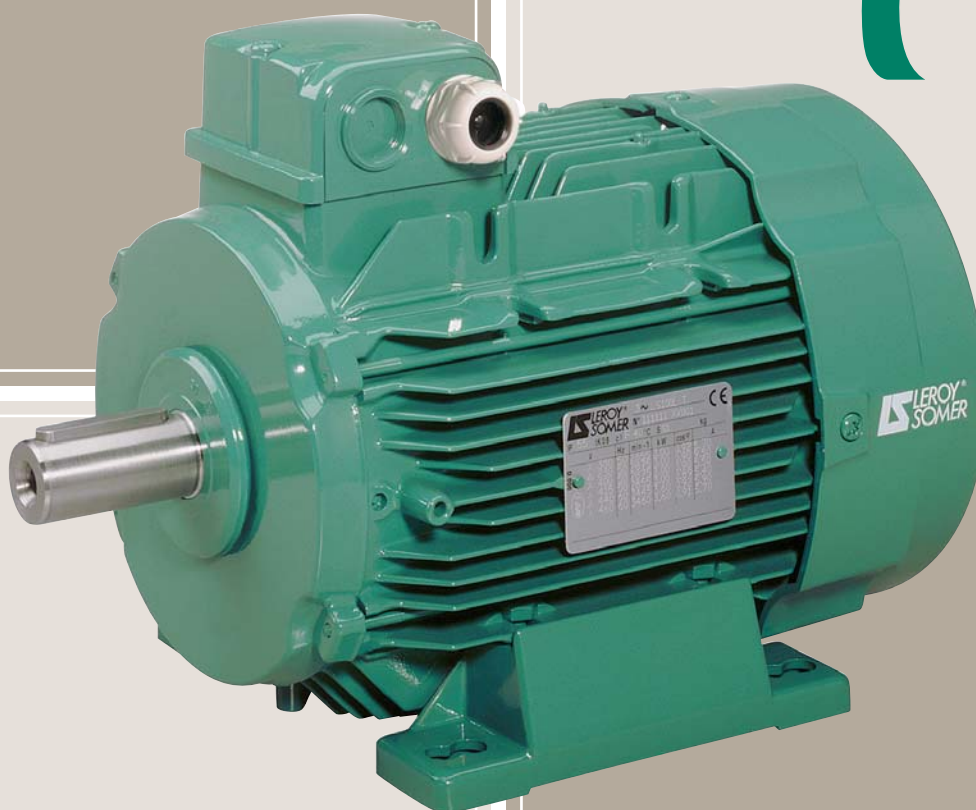

LS
3-phase TEFV cage induction motors
Aluminium alloy frame - 0.09 to 200 kW
Technical catalogue

3-phase TEFV induction motors LS aluminium alloy frame 0.09 to 200 kW

The LEROY-SOMER range of 3-phase motors



Other LEROY-SOMER motor ranges



Single phase induction motor



Cast iron motor



VARMECA variable speed motor



D.C. motor (drip-proof or enclosed)



Motor for variable speed drive systems



3-phase autosynchronous motor

DELIVERY WITH GUARANTEED AVAILABILITY

LEROY-SOMER offer their clients the opportunity to fix their own delivery dates, **without prior consultation.**



Information regarding products & availability can be found in **CATALOGUE ref: 3641** or **CD Rom ref: 3709**

Guaranteed delivery dates thanks to unique, high performance logistics.



3-phase TEFV induction motors LS aluminium alloy frame 0.09 to 200 kW

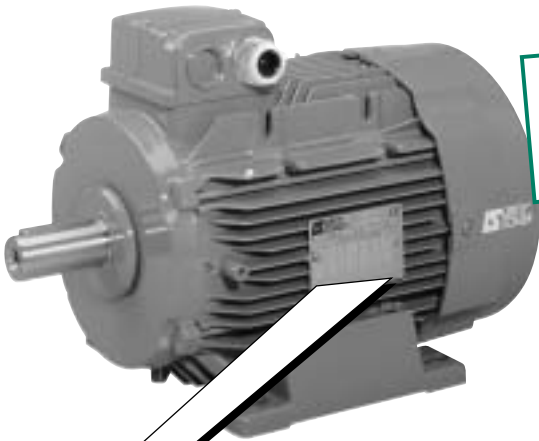

IP 55
Cl. F - ΔT 80 K
MULTI-VOLTAGE

Use the complete **motor designation** as shown below when placing your **order**.

Simply go through the designation step by step.

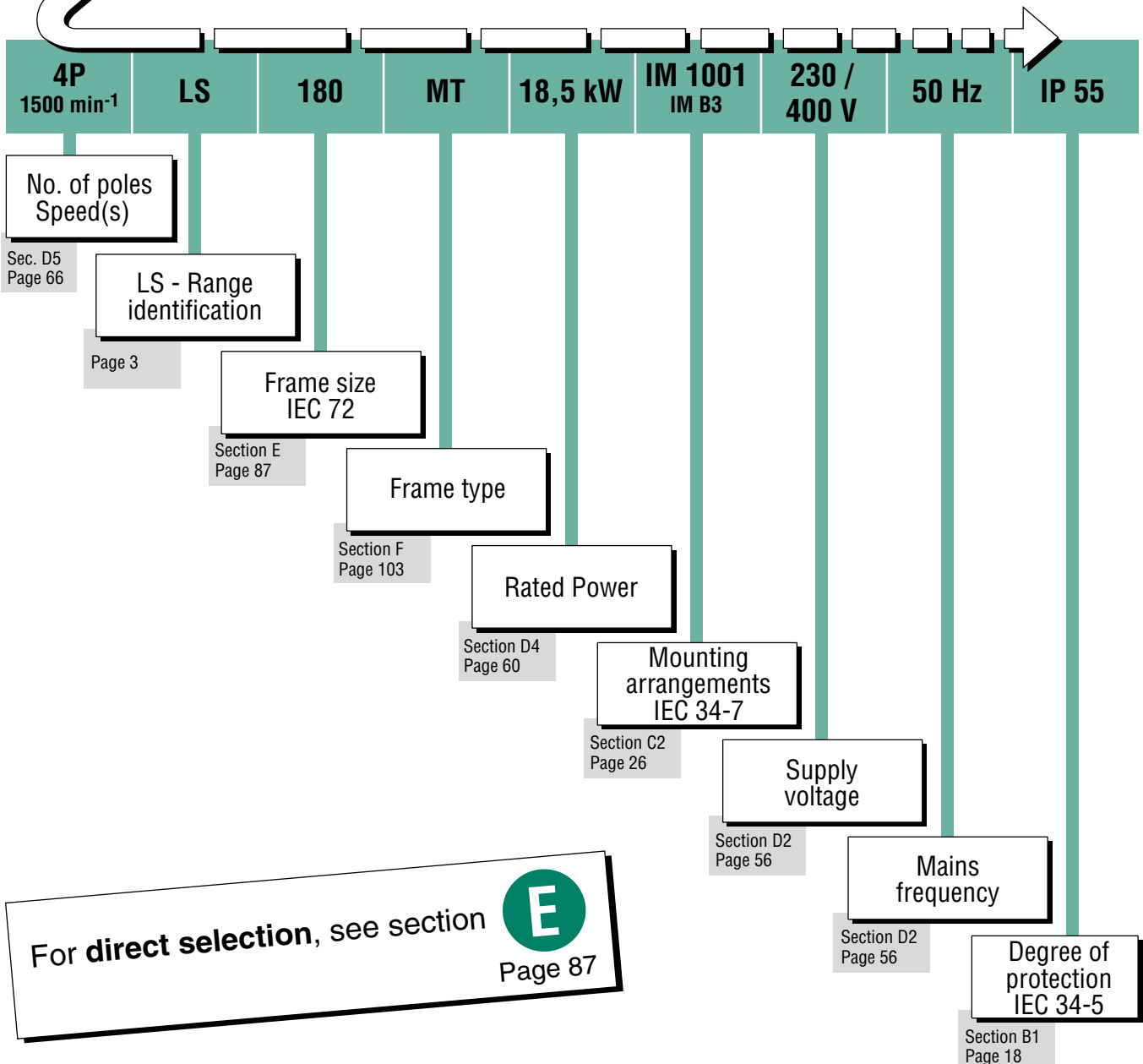

This document has been translated from the French version which should be used for reference.
LEROY-SOMER reserves the right to modify the design, technical specifications and dimensions of the products shown in this catalogue.
The descriptions cannot in any way be considered contractual.

3-phase TEFV induction motors LS aluminium alloy frame 0.09 to 200 kW

This catalogue gives full information about the **LEROY-SOMER LS 3-phase cage induction motor, 0.09 to 200 kW.**

Designed to the latest European standards, this aluminium alloy frame motor satisfies most industrial requirements, and sets the standard for the whole of the LEROY-SOMER range.

LEROY-SOMER also produces non standard motors and others, providing a range of power from 0.09 kW right up to 900 kW.

The selection chart can be used to find exactly the right motor for your application.

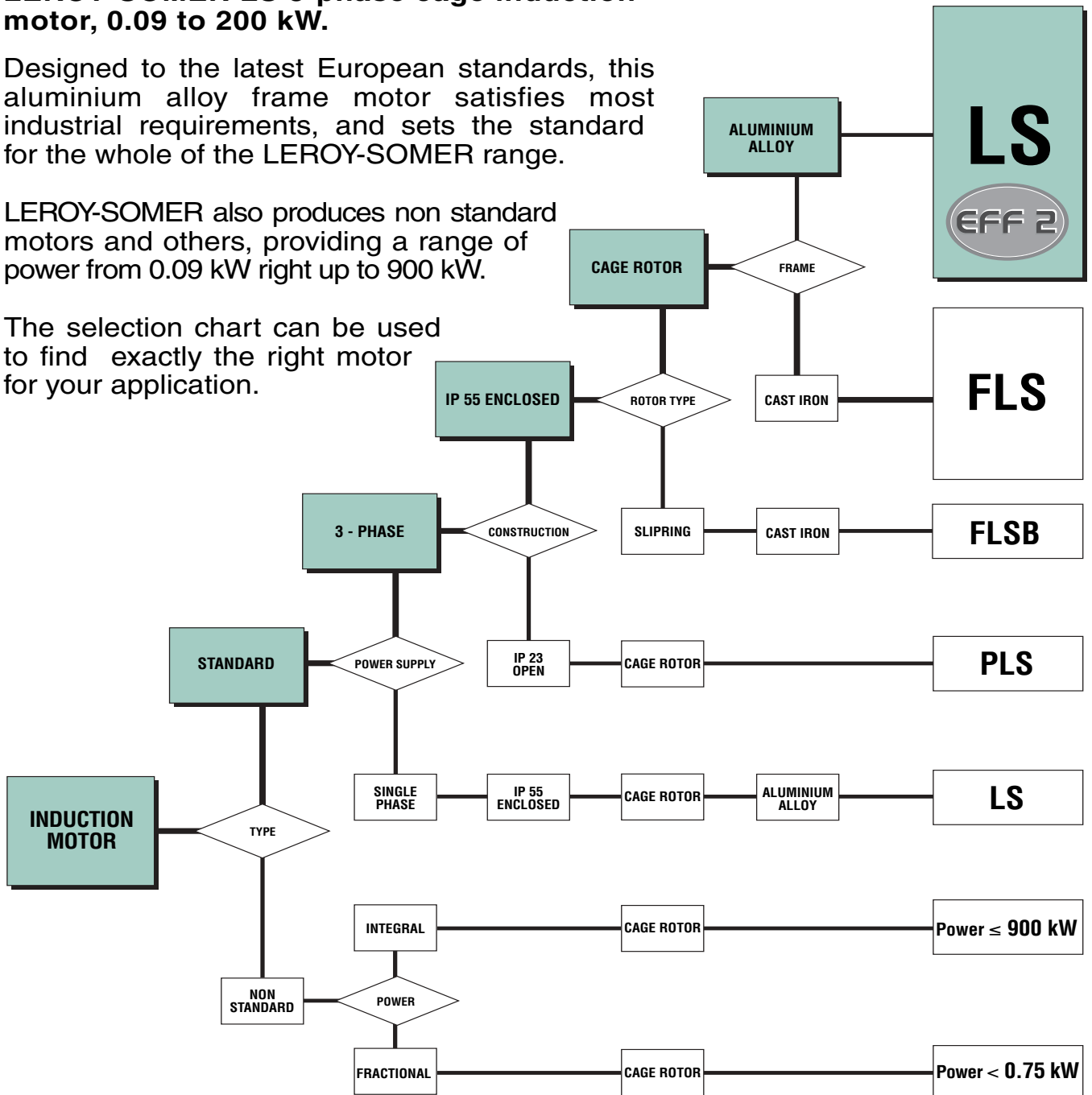

3-phase TEFV induction motors LS aluminium alloy frame

Contents

	PAGES		PAGES
A - GENERAL INFORMATION		C - CONSTRUCTION	
Quality assurance	7	Components	25
Standards and approvals	8	Mounting arrangements	26
Tolerance of main parameters	11	Mounting arrangements	26
Units of measurement and standard formulae	12	Mountings and positions (IEC standard 60034-7)	27
Electricity and electromagnetism	12	Bearings and lubrication	28
Thermodynamics	13	Types of bearing and standard fitting arrangements	28
Noise and vibration	13	Bearing assembly diagrams	29
Dimensions	13	Axial loads	30
Mechanics	14	Permissible axial load (in daN) on main shaft extension for standard bearing assembly	30
Unit conversions	15	Radial loads	33
Standard formulae used in electrical engineering	16	Permissible radial load on main shaft extension	33
Mechanical formulae	16	Standard mounting	34
Electrical formulae	17	Types and special fitting arrangements for DE roller bearings	37
B - ENVIRONMENT		Bearing assembly diagrams	37
Definition of "Index of Protection" (IP/IK)	18	Special mounting	38
Environmental limitations	19	Bearings and bearing life	40
Normal operating conditions	19	Lubrication and maintenance of bearings	41
Normal storage conditions	19	Lubrication with grease	41
Relative and absolute humidity	19	Grease life	41
Drain holes	19	Permanently greased bearings	41
Drip cover	19	Bearings without grease nipples	42
Impregnation and enhanced protection	20	Bearings with grease nipples	42
Normal atmospheric pressure	20	Special construction and environment	42
Influence of atmospheric pressure	21	Cooling method	43
Heaters	22	Standard codes	44
Space heaters	22	Ventilation	45
D.C. injection	22	Motor ventilation	45
A.C. injection	22	Non-ventilated applications in continuous operation	45
External finish	23	Mains connection	47
Interference suppression	24	Terminal box	47
		Flying leads	47
		Table of terminal boxes and cable glands for rated supply voltage of 400V (according to EN 50262)	48
		Terminal blocks - Direction of rotation	49
		Wiring diagrams	49
		Earth terminal	49
		Motor connections	50

3-phase TEFV induction motors LS aluminium alloy frame

Contents

	PAGES		PAGES
D - OPERATION			
Duty cycle - Definitions	53	Starting methods for cage induction motors	78
Supply voltage	56	Motor with associated electronics	78
Regulations and standards	56	Variable speed motor	78
Effects on motor performance	57	Braking methods	82
Voltage range	57	Operation as an asynchronous generator	84
Simultaneous variation of voltage and frequency	58	General	84
Use of 400V - 50 Hz motors on 460V - 60 Hz supplies	58	Operating characteristics	84
Use on supplies with U' voltages different from the voltages in the characteristics tables	58	Connection to a powerful mains supply	85
Phase voltage imbalance	58	Connection - Disconnection	85
Phase current imbalance	58	Reactive power compensation	85
Insulation class - Temperature rise and thermal reserve ..	59	Electrical protection and safety	85
Power - Torque - Efficiency - Power Factor (Cos φ)	60	Power supply for an isolated network.....	85
Definitions	60	Reactive power compensation	85
Efficiency	60	Characteristic curves.....	86
Influence of load on η and power factor $\cos \phi$	60	Regulation	86
Torque-speed characteristics	61	Control and protection	86
Calculation of accelerating torque and starting time	62	Performance of motors used as AG	86
Determination of the rated power Pn in relation to duty cycle ...	64	E - ELECTRICAL CHARACTERISTICS	
General rules for standard motors	64	Selection data: single-speed	88
Determination of the power in intermittent duty cycles for adapted motors	64	Selection data: two-speed	96
Equivalent thermal constant	64	F - DIMENSIONS	
Transient overload after operating in type S1 duty cycle	64	Dimensions of shaft extensions	104
Operation of a 3-phase motor from a single-phase power supply	65	Foot mounted	105
Speed of rotation	66	Foot and flange mounted	106
Single fixed speed motor	66	Flange mounted	107
High speed motor	66	Foot and face mounted	108
Low speed motor	66	Face mounted	109
Multiple fixed speeds motor	66	G - OPTIONAL FEATURES	
Motor with single winding	66	Non-standard flanges	110
Motor with separate windings	66	Drip covers	111
Behaviour of two-speed motors	67	Options	112
Operating rules	67	LS motors with optional features	112
2-speed motors with connected windings.....	67	Dimensions of LS motors with optional features	113
Special cases	68	Safety options	114
Variable speeds	68	H - INSTALLATION AND MAINTENANCE	
Slip variation at fixed frequency.....	68	Voltage drop along cables (standard NFC 15 100)	117
Frequency variation	68	Earthing impedance	118
Noise and vibration	71	Packaging weights and dimensions	119
Motor noise levels.....	71	Position of the lifting rings	120
Noise emitted by rotating machines	71	Identification, exploded views and parts list	121
Noise levels for machines at full load	72	Nameplates	121
Vibration levels - Balancing	73	Frame size: 56 to 132	122
Performance	75	Frame size: 160 and 180	123
Thermal protection	75	Frame size: 200 and 225	124
Power factor correction	76	Frame size: 250 and 280	125
Motors operating in parallel	77	Frame size: 315	126
		Maintenance	127

3-phase TEFV induction motors LS aluminium alloy frame

Index

	PAGES		PAGES
AFNOR.....	8	Mains connection	47
Altitude	19	Maintenance.....	127
Ambient temperature.....	19	Mounting arrangements	26
Approvals.....	8	Multi-speed motors.....	66
Approvals.....	9	Nameplates	121
Asynchronous generator	84	NEMA	8
Balancing	73	Noise	71
Ball bearings.....	28	Noise levels	71
Braking	82	Non-ventilated motors	46
Cable gland	48	Operating positions	26
Cables	117	Options	112
Connection	49	Packaging.....	119
Connection	50	Parts list.....	122
Connection diagrams.....	49	Permissible axial load.....	30
Cooling	43	Permissible radial load	33
Cos φ (Power Factor).....	60	Phase imbalance.....	58
CSA	9	Power.....	60
DIGISTART	78	Power Factor (Cos φ) correction.....	76
Dimensions.....	103	Quality	7
DIN /VDE	8	Reverse-current.....	82
Direction of rotation	49	Roller bearings	37
Drain holes	19	Rotor	25
Drip covers	19	Safety	114
Duty types	53	Safety options.....	114
Earth terminal.....	49	Selection data.....	87
Earthing.....	118	Serial number	121
Efficiency	60	Single-speed	87
Electrical shaft.....	77	Slip	68
EMC DIRECTIVES	24	Special fitting arrangement.....	37
EN	10	Speed of rotation	66
End shields.....	25	Standard fitting arrangement.....	34
Environment	19	Standards	8
Exploded views.....	122	Starting methods	78
External finish.....	23	Starting time	62
Fan cover	25	Stator.....	25
Flange	106	Supply voltage.....	56
Forced ventilation	45	Temperature rise	59
Formulae	16	Terminal blocks.....	49
Frequency variation	68	Terminal box	47
Grease.....	41	Thermal protection	75
Greasing.....	41	Thermal reserve	59
Heaters.....	22	Tolerance	11
Housing with cooling fins.....	25	Torque	60
Humidity	19	Torque curves.....	61
HYPER CONTROL	78	Two-speed motors	87
Identification	121	UL	9
IEC	8	UNISTART	78
Impregnation	20	Unit conversions	15
Index of protection	18	Units	12
Insulation	59	UTE	8
Insulation class.....	59	Variable speeds.....	68
Interference suppression	24	VARMECA	78
Interference suppression.....	24	Ventilation	45
Intermittent duty.....	64	Vibration	71
ISO 9001	7	Vibration levels	73
JIS	8	Voltage drop	117
Key	73		
Lifting rings.....	120		
Locked rotor time.....	63		
Lubrication.....	41		

3-phase TEFV induction motors LS aluminium alloy frame General information

A1 - Quality assurance

Industrial concerns are having to cope with an ever more competitive environment. Productivity depends to a considerable degree on the right investment at the right time. LEROY-SOMER has the answer, building motors to precise standards of quality.

When carrying out quality checks on a machine's performance, the first step is to **measure the level of customer satisfaction**.

Careful study of this information tells us which points need looking at, improving and monitoring.

From the moment you place your order with our administrative staff until the motor is up and running (after design studies, launch and production activities) we keep you informed and involved.

Our own procedures are constantly under review. All our staff are involved in both operational process analysis and continuous training programmes. These initiatives help them serve you better, and increased skills bring increased motivation.

At LEROY-SOMER, we think it vital for our customers to know the importance we attach to quality.

LEROY-SOMER has entrusted the certification of its expertise to various international organizations.

Certification is granted by independent professional auditors, and recognises the high standards of the **company's quality assurance procedures**.

All activities resulting in the final version of the machine have therefore received official **ISO 9000** accreditation,

Edition 2000. Products are also approved by official bodies who inspect their technical performance with regard to the various standards.

This is a fundamental requirement for a company of international standing.



DNV
DET NORSE
VERITAS



ATTESTATION



BUREAU
VERITAS



INERIS

3-phase TEFV induction motors LS aluminium alloy frame General information

A2 - Standards and approvals

ORGANIZATION OF STANDARDS AUTHORITIES

International bodies

<p>Worldwide</p> 	<p>General Standardization</p> <p>ISO</p> <p>International Standards Organization</p> <div style="display: flex; justify-content: space-around;"> <div style="border: 1px solid black; padding: 2px; text-align: center;">TC Technical committees</div> <div style="border: 1px solid black; padding: 2px; text-align: center;">SC Sub-committees</div> <div style="border: 1px solid black; padding: 2px; text-align: center;">WG Working groups</div> </div>	<p>Electronics / Electrotechnical Standardization</p> <p>IEC</p> <p>International Electrotechnical Commission</p> <div style="display: flex; justify-content: space-around;"> <div style="border: 1px solid black; padding: 2px; text-align: center;">TC Technical committees</div> <div style="border: 1px solid black; padding: 2px; text-align: center;">SC Sub-committees</div> <div style="border: 1px solid black; padding: 2px; text-align: center;">WG Working groups</div> </div>
<p>European</p> 	<p>CEN</p> <p>European Committee for Standardization</p> <p>ECISS</p> <p>European Committee for Iron and Steel Standards</p> <div style="border: 1px solid black; padding: 2px; text-align: center; margin-top: 10px;">TC Technical committees</div>	<p>CENELEC</p> <p>European Committee for Electrotechnical Standardization</p> <div style="display: flex; justify-content: space-around; margin-top: 10px;"> <div style="border: 1px solid black; padding: 2px; text-align: center;">TC Technical committees</div> <div style="border: 1px solid black; padding: 2px; text-align: center;">SC Sub-committees</div> <div style="border: 1px solid black; padding: 2px; text-align: center;">AHG Ad Hoc Groups</div> </div>

Country	Initials	Designation
AUSTRALIA	SAA	Standards Association of Australia
BELGIUM	IBN	Institut Belge de Normalisation
CIS (ex-USSR)	GOST	Gosudarstvenno Komitet Standartov
DENMARK	DS	Dansk Standardiseringsraad
FINLAND	SFS	Suomen Standardisoimisliitto
FRANCE	AFNOR including UTE	Association Française de Normalisation including: Union Technique de l'Électricité
GERMANY	DIN/VDE	Verband Deutscher Elektrotechniker
GREAT BRITAIN	BSI	British Standards Institution
ITALY	IEC	Comitato Electrotecnico Italiano
JAPAN	JIS	Japanese Industrial Standard
NETHERLANDS	NNI	Nederlands Normalisatie - Instituut
NORWAY	NFS	Norges Standardiseringsforbund
SAUDI ARABIA	SASO	Saudi Arabian Standards Organization
SPAIN	UNE	Una Norma Española
SWEDEN	SIS	Standardiseringskommissionen I Sverige
SWITZERLAND	SEV or ASE	Schweizerischer Elektrotechnischer Verein
UNITED STATES	ANSI including NEMA	American National Standards Institute including: National Electrical Manufacturers

3-phase TEFV induction motors LS aluminium alloy frame General information

A2 - Standards and approvals

Approvals

Certain countries recommend or insist on approval from national organizations.

Approved products must carry the recognized mark on their identification plates.

Country	Initials	Organization
USA	UL	Underwriters Laboratories
CANADA	CSA	Canadian Standards Association
etc.		

Approvals for LEROY-SOMER motors (versions derived from standard construction):

Country	Initials	Certification No.	Application
CANADA	CSA	LR 57 008	Standard adapted range (see section D2.2.3)
USA	UL or ƆJ	E 68554 SA 6704 E 206450	Impregnation systems Stator/rotor assemblies for sealed units Complete motors up to 160 frame size
SAUDI ARABIA	SASO		Standard range
FRANCE	LCIE INERIS	Various nos.	Sealing, shocks, safety

For specific approved products, see the relevant documents.

International and national standard equivalents

International reference standards		National standards				
IEC	Title (summary)	FRANCE	GERMANY	U.K.	ITALY	SWITZERLAND
60034-1	Ratings and operating characteristics	NFEN 60034-1 NFC 51-120 NFC 51-200	DIN/VDE O530	BS 4999	CEI 2.3.VI.	SEV ASE 3009
60034-2	Determination of losses and efficiency	NFEN 60034-2	DIN/EN 60034-2	BS 4999-102		
60034-5	Classification of degrees of protection	NFEN 60034-5	DIN/EN 60034-5	BS EN 60034-5	UNEL B 1781	
60034-6	Cooling methods	NFEN 60034-6	DIN/EN 60034-6	BS EN 60034-6		
60034-7	Mounting arrangements and assembly layouts	NFEN 60034-7	DIN/EN 60034-7	BS EN 60034-7		
60034-8	Terminal markings and direction of rotation	NFC 51 118	DIN/VDE 0530 Teil 8	BS 4999-108		
60034-9	Noise limits	NFEN 60034-9	DIN/EN 60034-9	BS EN 60034-9		
60034-12	Starting characteristics for single-speed motors powered from the mains ≤ 660 V	NFEN 60034-12	DIN/EN 60034-12	BS EN 60034-12		SEV ASE 3009-12
60034-14	Mechanical vibration in machines of frame size > 56 mm	NFEN 60034-14	DIN/EN 60034-14	BS EN 60034-14		
60072-1	Dimensions and output powers for machines of between 56 and 400 frame and flanges of between 55 and 1080	NFC 51 104 NFC 51 105	DIN 748 (-) DIN 42672 DIN 42673 DIN 42631 DIN 42676 DIN 42677	BS 4999		
60085	Evaluation and thermal classification of electrical insulation	NFC 26206	DIN/EN 60085	BS 2757		SEV ASE 3584

Note: DIN 748 tolerances do not conform to IEC 60072-1.

3-phase TEFV induction motors LS aluminium alloy frame General information

A2 - Standards and approvals

*LS motors comply with the standards
quoted in this catalogue*

List of standards quoted in this document

Reference		Date	International standards
IEC 60034-1	EN 60034-1	1999	Electrical rotating machines: ratings and operating characteristics
IEC 60034-5	EN 60034-5	2000	Electrical rotating machines: classification of degrees of protection provided by casings of rotating machines.
IEC 60034-6	EN 60034-6	1993	Electrical rotating machines (except traction): cooling methods
IEC 60034-7	EN 60034-7	2000	Electrical rotating machines (except traction): symbols for mounting positions and assembly layouts
IEC 60034-8		2001	Electrical rotating machines: terminal markings and direction of rotation
IEC 60034-9	EN 60034-9	1997	Electrical rotating machines: noise limits
IEC 60034-12	EN 60034-12	1999	Starting characteristics for single-speed 3-phase cage induction motors for supply voltages less than or equal to 660V.
IEC 60034-14	EN 60034-14	1996	Electrical rotating machines: mechanical vibrations of certain machines with a frame size above or equal to 56 mm. Measurement, evaluation and limits of vibrational intensity.
IEC 60038		1999	IEC standard voltages
IEC 60072-1		1991	Dimensions and power series for electrical rotating machines: designation of casings between 56 and 400 and flanges between 55 and 1080.
IEC 60085		1984	Evaluation and thermal classification of electrical insulation.
IEC 60721-2-1		1987	Classification of natural environment conditions. Temperature and humidity.
IEC 60892		1987	Effects of an imbalance in the voltage system on the characteristics of three-phase squirrel-cage induction motors.
IEC 61000-2-10/11 and		1999	Electromagnetic compatibility (EMC): environment
IEC guide 106		1989	Guidelines on the specification of environmental conditions for the determination of operating characteristics of equipment.
ISO 281		2000	Bearings - Basic dynamic loadings and nominal bearing life
ISO 1680	EN 21680	1999	Acoustics - Test code for measuring airborne noise emitted by electrical rotating machines: a method for establishing an expert opinion for free field conditions over a reflective surface
ISO 8821		1999	Mechanical vibration - Balancing. Conventions on shaft keys and related parts
	EN 50102	1998	Degree of protection provided by the electrical housing against extreme mechanical impacts.

3-phase TEFV induction motors LS aluminium alloy frame General information

A3 - Tolerance on main performance parameters

Tolerances for electromechanical characteristics

IEC 60034-1 specifies standard tolerances for electromechanical characteristics.

Parameters	Tolerances
Efficiency { machines P ≤ 50 kW machines P > 50 kW	- 15% (1 - η) - 10% (1 - η)
Cos φ	- 1/6 (1 - cos φ) (min 0.02 - max 0.07)
Slip { machines P < 1 kW machines P ≥ 1 kW	± 30% ± 20%
Locked rotor torque	- 15%, + 25% of rated torque
Starting current	+ 20%
Run-up torque	- 15% of rated torque
Breakdown torque	- 10% of rated torque > 1.5 M _N
Moment of inertia	± 10%
Noise	+ 3 dB (A)
Vibration	+ 10% of the guaranteed class

Note: IEC 60034-1 does not specify tolerances for current
the tolerance is ± 10% in NEMA-MG1

Tolerances and adjustments

The standard tolerances shown below are applicable to the drawing dimensions given in our catalogues. They comply fully with the requirements of IEC standard 60072-1.

Characteristics	Tolerances
Frame size H ≤ 250 ≥ 280	0, — 0.5 mm 0, — 1 mm
Diameter Ø of shaft extension: - 11 to 28 mm - 32 to 48 mm - 55 mm and over	j6 k6 m6
Diameter N of flange spigot	j6 up to FF 500, js6 for FF 600 and over
Key width	h9
Width of drive shaft keyway (normal keying)	N9
Key depth - square section - rectangular section	h9 h11
① Eccentricity of shaft in flanged motors (standard class) - diameter > 10 up to 18 mm - diameter > 18 up to 30 mm - diameter > 30 up to 50 mm - diameter > 50 up to 80 mm - diameter > 80 up to 120 mm	0.035 mm 0.040 mm 0.050 mm 0.060 mm 0.070 mm
② Concentricity of spigot diameter and ③ perpendicularity of mating surface of flange in relation to shaft (standard class) Flange (FF) or Faceplate (FT): - F 55 to F 115 - F 130 to F 265 - FF 300 to FF 500 - FF 600 to FF 740 - FF 940 to FF 1080	0.08 mm 0.10 mm 0.125 mm 0.16 mm 0.20 mm

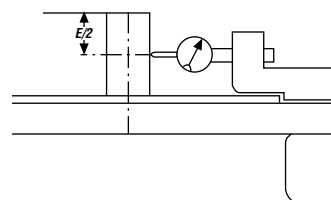

① Eccentricity of shaft in flanged motors

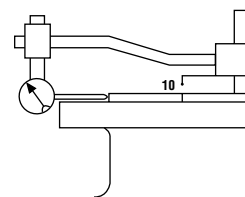

② Concentricity of spigot diameter

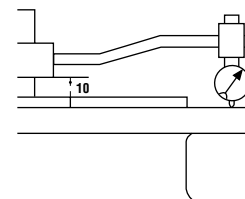

③ Perpendicularity of mating surface of flange in relation to shaft

3-phase TEFV induction motors LS aluminium alloy frame General information

A4 - Units of measurement and standard formulae

A4.1 - ELECTRICITY AND ELECTROMAGNETISM

Parameters				Unit		Units and expressions not recommended
Name	French name	Symbol	Definition	SI	Non SI, but accepted	Conversion
Frequency Period	Fréquence	f	$f = \frac{1}{T}$	Hz (hertz)		
Electric current	Courant électrique (intensité de)	I		A (ampere)		
Electric potential Voltage Electromotive force	Potentiel électrique Tension Force électromotrice	V U E		V (volt)		
Phase angle	Déphasage	φ	$U = Um \cos \omega t$ $i = Im \cos (\omega t - \varphi)$	rad	° degree	
Power factor	Facteur de puissance	$\cos \varphi$				
Reactance Resistance Impedance	Réactance Résistance Impédance	X R Z	$Z = Z ^{j\varphi}$ $= R + jX$ $ Z = \sqrt{R^2 + X^2}$ $X = L\omega - \frac{1}{C\omega}$	Ω (ohm)		j is defined as $j^2 = -1$ ω pulsation = $2\pi \cdot f$
Self inductance	Inductance propre (self)	L	$L = \frac{\Phi}{I}$	H (henry)		
Capacitance	Capacité	C	$C = \frac{Q}{V}$	F (farad)		
Quantity of electricity	Charge électrique, Quantité d'électricité	Q	$Q = \int i dt$	C (coulomb)	A.h 1 A.h = 3600 C	
Resistivity	Résistivité	ρ	$\rho = \frac{R \cdot S}{l}$	$\Omega \cdot m$		Ω/m
Conductance	Conductance	G	$G = \frac{1}{R}$	S (siemens)		$1/\Omega = 1 S$
Number of turns (coil) Number of phases Number of pairs of poles	Nombre de tours (spires) de l'enroulement Nombre de phases Nombre de paires de pôles	N m p				
Magnetic field	Champ magnétique	H		A/m		
Magnetic potential difference Magnetomotive force	Différence de potentiel magnétique Force magnétomotrice Solénation, courant totalisé	Um F, Fm H	$F = \phi H_s d_s$ $H = NI$	A		The unit AT (ampere-turns) is incorrect because it treats "turn" as a physical unit
Magnetic induction, Magnetic flux density	Induction magnétique, Densité de flux	B		T (tesla) = Wb/m ²		(gauss) 1 G = 10 ⁻⁴ T
Magnetic flux	Flux magnétique, Flux d'induction magnétique	Φ	$\Phi = \int f_s Bn ds$	Wb (weber)		(maxwell) 1 max = 10 ⁻⁸ Wb
Magnetic vector potential	Potentiel vecteur	A		Wb/m		
Permeability Permeability of vacuum	Perméabilité du milieu Perméabilité du vide	$\mu = \mu_0 \mu_r$ μ_0	$B = \mu H$ $\mu_0 = 4\pi 10^{-7} H/m$	H/m		
Permittivity	Permittivité	$\epsilon = \epsilon_0 \epsilon_r$	$\epsilon_0 = \frac{1}{36\pi 10^9} F/m$	F/m		

3-phase TEFV induction motors LS aluminium alloy frame General information

A4 - Units of measurement and standard formulae

A4.2 - THERMODYNAMICS

Parameters				Unit		Units and expressions not recommended
French name	English name	Symbol	Definition	SI	Non SI, but accepted	Conversion
Temperature Thermodynamic	Température Thermodynamique	T		K (kelvin)	temperature Celsius, t , °C $T = t + 273.15$	°C: Degree Celsius t_C : temp. in °C t_F : temp. in °F f temperature Fahrenheit °F $t = \frac{f-32}{1.8}$ $t_C = \frac{t_F-32}{1.8}$
Temperature rise	Ecart de température	ΔT		K	°C.	1 °C = 1 K
Thermal flux density	Densité de flux thermique	q, φ	$q = \frac{\Phi}{A}$	W/m ²		
Thermal conductivity	Conductivité thermique	λ		W/m.K		
Total heat transmission coefficient	Coefficient de transmission thermique globale	K	$\varphi = K(T_{r_2} - T_{r_1})$	W/m ² .K		
Thermal capacity	Capacité thermique	C	$C = \frac{dQ}{dT}$	J/K		
Specific thermal capacity	Capacité thermique massique	c	$c = \frac{C}{m}$	J/kg.K		
Internal energy	Energie interne	U		J		

A4.3 - NOISE AND VIBRATION

Parameters				Unit		Units and expressions not recommended
Name	French name	Symbol	Definition	SI	Non SI, but accepted	Conversion
Sound power level	Niveau de puissance acoustique	L_W	$L_W = 10 \lg(P/P_0)$ ($P_0 = 10^{-12} W$)	dB (decibel)		lg logarithm to base 10 $\lg 10 = 1$
Sound pressure level	Niveau de pression acoustique	L_p	$L_p = 20 \lg(P/P_0)$ ($P_0 = 2 \times 10^{-5} Pa$)	dB		

A4.4 - DIMENSIONS

Parameters				Unit		Units and expressions not recommended
Name	French name	Symbol	Definition	SI	Non SI, but accepted	Conversion
Angle (plane angle)	Angle (angle plan)	$\alpha, \beta, T, \varphi$		rad	degree: ° minute: ' second: "	180° = π rad = 3.14 rad
Length Width Height Radius	Longueur Largeur Hauteur Rayon Longueur curviligne	l b h r s		m (metres)	micrometre	cm, dm, dam, hm 1 inch = 1" = 25.4 mm 1 foot = 1' = 304.8 mm μ m micron μ angström: Å = 0.10 nm
Area	Aire, superficie	A, S		m ²		1 square inch = $6.45 \cdot 10^{-4} m^2$
Volume	Volume	V		m ³	litre: l liter: L	UK gallon = $4.546 \cdot 10^{-3} m^3$ US gallon = $3.785 \cdot 10^{-3} m^3$

3-phase TEFV induction motors

LS aluminium alloy frame

General information

A4 - Units of measurement and standard formulae

A4.5 - MECHANICS AND MOVEMENT

Parameters				Unit		Units and expressions not recommended
Name	French name	Symbol	Definition	SI	Non SI, but accepted	Conversion
Time	Temps	t				
Period (duration of cycle)	Intervalle de temps, durée Période (durée d'un cycle)	T		s (second)	minute: min hour: h day: d	Symbols ' and " are reserved for angles minute not written as mn
Angular velocity	Vitesse angulaire	ω	$\omega = \frac{d\phi}{dt}$	rad/s		
Rotational frequency	Pulsation					
Angular acceleration	Accélération angulaire	α	$\alpha = \frac{d\omega}{dt}$	rad/s ²		
Speed	Vitesse	$u, v, w,$	$v = \frac{ds}{dt}$		1 km/h = 0.277 778 m/s	
Velocity	Célérité	c		m/s	1 m/min = 0.016 6 m/s	
Acceleration	Accélération	a	$a = \frac{dv}{dt}$	m/s ²		
Acceleration of free fall	Accélération de la pesanteur	$g=9.81\text{m/s}^2$	<i>in Paris</i>			
Speed of rotation	Vitesse de rotation	N		s ⁻¹	min ⁻¹	tr/mn, RPM, TM...
Weight	Masse	m		kg (kilogram)	tonne: t 1 t = 1000 kg	kilo, kgs, KG... 1 pound: 1 lb = 0.4536 kg
Mass density	Masse volumique	ρ	$\frac{dm}{dV}$	kg/m ³		
Linear density	Masse linéique	ρ_e	$\frac{dm}{dL}$	kg/m		
Surface density	Masse surfacique	ρ_A	$\frac{dm}{dS}$	kg/m ²		
Momentum	Quantité de mouvement	P	$p = m.v$	kg. m/s		
Moment of inertia	Moment d'inertie	J, I	$I = \sum m.r^2$	kg.m ²		$J = \frac{MD^2}{4}$ kg.m ² pound per square foot = 1 lb.ft ² = 42.1 x 10 ⁻³ kg.m ²
Force	Force	F		N (newton)		kgf = kgp = 9.81 N pound force = lbF = 4.448 N
Weight	Poids	G	$G = m.g$			
Moment of force	Moment d'une force	M	$M = F.r$	N.m		mdaN, mkg, m.N 1 mkg = 9.81 N.m 1 ft.lbF = 1.356 N.m 1 in.lbF = 0.113 N.m
Torque		T				
Pressure	Pression	p	$p = \frac{F}{S} = \frac{F}{A}$	Pa (pascal)	bar 1 bar = 10 ⁵ Pa	1 kgf/cm ² = 0.981 bar 1 psi = 6894 N/m ² = 6894 Pa 1 psi = 0.06894 bar 1 atm = 1.013 x 10 ⁵ Pa
Normal stress	Contrainte normale	σ		Pa		kg/mm ² , 1 daN/mm ² = 10 MPa
Shear stress,	Contrainte tangentielle	τ		Pa		psi = pound per square inch 1 psi = 6894 Pa
Friction coefficient	Facteur de frottement	μ				incorrectly = friction coefficient f
Work	Travail	W	$W = F.l$			1 N.m = 1 W.s = 1 J
Energy	Énergie	E			Wh = 3600 J (watt-hour)	1 kgm = 9.81 J (calorie) 1 cal = 4.18 J
Potential energy	Énergie potentielle	E_p				1 Btu = 1055 J
Kinetic energy	Énergie cinétique	E_k				(British thermal unit)
Quantity of heat	Quantité de chaleur	Q				
Power	Puissance	P	$P = \frac{W}{t}$	W (watt)		1 ch = 736 W 1 HP = 746 W
Volumetric flow	Débit volumique	q_v	$q_v = \frac{dV}{dt}$	m ³ /s		
Efficiency	Rendement	η		< 1		%
Dynamic viscosity	Viscosité dynamique	η, μ		Pa.s		poise, 1 P = 0.1 Pa.s
Kinematic viscosity	Viscosité cinématique	ν	$\nu = \frac{\eta}{\rho}$	m ² /s		stokes, 1 St = 10 ⁻⁴ m ² /s

3-phase TEFV induction motors LS aluminium alloy frame General information

A5 - Unit conversions



Unit	MKSA (IS international system)	AGMA (US system)
Length	1 m = 3.2808 ft 1 mm = 0.03937 in	1 ft = 0.3048 m 1 in = 25.4 mm
Weight	1 kg = 2.2046 lb	1 lb = 0.4536 kg
Torque	1 Nm = 0.7376 lb.ft 1 N.m = 141.6 oz.in	1 lb.ft = 1.356 N.m 1 oz.in = 0.00706 N.m
Force	1 N = 0.2248 lb	1 lb = 4.448 N
Moment of inertia	1 kg.m ² = 23.73 lb.ft ²	1 lb.ft ² = 0.04214 kg.m ²
Power	1 kW = 1.341 HP	1 HP = 0.746 kW
Pressure	1 kPa = 0.14505 psi	1 psi = 6.894 kPa
Magnetic flux	1 T = 1 Wb / m ² = 6.452 · 10 ⁴ line / in ²	1 line / in ² = 1.550 · 10 ⁻⁵ Wb / m ²
Magnetic losses	1 W / kg = 0.4536 W / lb	1 W / lb = 2.204 W / kg

Multiples and sub-multiples		
Factor by which the unit is multiplied	Prefix to be placed before the unit name	Symbol to be placed before that of the unit
10 ¹⁸ or 1,000,000,000,000,000,000	exa	E
10 ¹⁵ or 1,000,000,000,000,000	peta	P
10 ¹² or 1,000,000,000,000	tera	T
10 ⁹ or 1,000,000,000	giga	G
10 ⁶ or 1,000,000	mega	M
10 ³ or 1,000	kilo	k
10 ² or 100	hecto	h
10 ¹ or 10	deca	da
10 ⁻¹ or 0.1	deci	d
10 ⁻² or 0.01	centi	c
10 ⁻³ or 0.001	milli	m
10 ⁻⁶ or 0.000,001	micro	μ
10 ⁻⁹ or 0.000,000,001	nano	n
10 ⁻¹² or 0.000,000,000,001	pico	p
10 ⁻¹⁵ or 0.000,000,000,000,001	femto	f
10 ⁻¹⁸ or 0.000,000,000,000,000,001	atto	a

3-phase TEFV induction motors

LS aluminium alloy frame

General information

A6 - Standard formulae used in electrical engineering

A6.1 - MECHANICAL FORMULAE

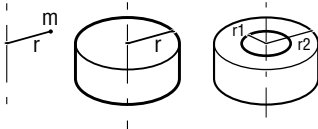
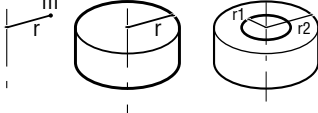
Title	Formula	Unit	Definitions / notes
Force	$F = m \cdot \gamma$	F in N m in kg γ in m/s^2	A force F is the product of a mass m by an acceleration γ
Weight	$G = m \cdot g$	G in N m in kg $g = 9.81 \text{ m/s}^2$	
Moment	$M = F \cdot r$	M in N.m F in N r in m	The moment M of a force in relation to an axis is the product of that force multiplied by the distance r of the point of application of F in relation to the axis.
Power - Rotation	$P = M \cdot \omega$	P in W M in N.m ω in rad/s	Power P is the quantity of work yielded per unit of time $\omega = 2\pi N/60$ where N is the speed of rotation in min^{-1}
- Linear	$P = F \cdot V$	P in W F in N V in m/s	$V =$ linear velocity
Acceleration time	$t = J \cdot \frac{\omega}{M_a}$	t in s J in kg.m^2 ω in rad/s M_a in Nm	J is the moment of inertia of the system M_a is the moment of acceleration Note: all the calculations refer to a single rotational speed ω where the inertias at speed ω' are corrected to speed ω by the following calculation: $J_\omega = J_{\omega'} \cdot \left(\frac{\omega'}{\omega}\right)^2$
Moment of inertia Centre of gravity	$J = m \cdot r^2$		
Solid cylinder around its shaft	$J = m \cdot \frac{r^2}{2}$	J in kg.m^2 m in kg r in m	
Hollow cylinder around its shaft	$J = m \cdot \frac{r_1^2 + r_2^2}{2}$		
Inertia of a mass in linear motion	$J = m \cdot \left(\frac{V}{\omega}\right)^2$	J in kg.m^2 m in kg v in m/s ω in rad/s	The moment of inertia of a mass in linear motion transformed to a rotating motion.

3-phase TEFV induction motors

LS aluminium alloy frame

General information

A6 - Standard formulae used in electrical engineering

A6.2 - ELECTRICAL FORMULAE

Title	Formula	Unit	Definitions / notes
Accelerating torque	$M_a = \frac{M_D + 2M_A + 2M_M + M_N}{6} - M_r$ <p>General formula:</p> $M_a = \frac{1}{N_N} \int_0^{N_N} (M_{mot} - M_r) dN$	Nm	Moment of acceleration M_a is the difference between the motor torque M_{mot} (estimated), and the resistive torque M_r . (M_D , M_A , M_M , M_N , see curve below) N = instantaneous speed N_N = rated speed
Power required by machine	$P = \frac{M \cdot \omega}{\eta_A}$	P in W M in N.m ω in rad/s η_A no unit	η_A expresses the efficiency of the driven machine. M is the torque required by the driven machine.
Power drawn by the 3-phase motor	$P = \sqrt{3} \cdot U \cdot I \cdot \cos \varphi$	P in W U in V I in A	φ phase angle by which the current lags or leads the voltage. U phase to phase voltage. I line current.
Reactive power absorbed by the motor	$Q = \sqrt{3} \cdot U \cdot I \cdot \sin \varphi$	Q in VAR	
Reactive power supplied by a bank of capacitors	$Q = \sqrt{3} \cdot U^2 \cdot C \cdot \omega$	U in V C in μ F ω in rad/s	U = voltage at the capacitor terminals C = capacitor capacitance ω = rotational frequency of supply phases ($\omega = 2\pi f$)
Apparent power	$S = \sqrt{3} \cdot U \cdot I$ $S = \sqrt{P^2 + Q^2}$	S in VA	
Power supplied by 3-phase motor	$P = \sqrt{3} \cdot U \cdot I \cdot \cos \varphi \cdot \eta$		η expresses motor efficiency at the point of operation under consideration.
Slip	$g = \frac{N_S - N}{N_S}$		Slip is the difference between the actual motor speed N and the synchronous speed N_S
Synchronous speed	$N_S = \frac{120 \cdot f}{p}$	N_S in min^{-1} f in Hz	p = number of poles f = frequency of the power supply

Parameters	Symbol	Unit	Torque and current curve according to speed
Starting current Rated current No-load current	I_D I_N I_O	A	
Starting torque* Run up torque	M_D M_A	Nm	
Breakdown torque	M_M	Nm	
Rated torque	M_N	Nm	
Rated speed Synchronous speed	N_N N_S	min^{-1}	

* Torque is the usual term for expressing the moment of a force.

3-phase TEFV induction motors LS aluminium alloy frame Environment

B1 - Definition of "Index of Protection" (IP/IK)

Indices of protection of electrical equipment enclosures
In accordance with IEC 60034-5 - EN 60034-5 (IP) - EN 50102 (IK)

LS motors are IP 55/IK 08
as standard

First number : protection against solid objects			Second number : protection against liquids			Third number: mechanical protection		
IP	Tests	Definition	IP	Tests	Definition	IK	Tests	Definition
0		No protection	0		No protection	00		No protection
1	∅ 50 mm 	Protected against solid objects of over 50 mm (eg : accidental hand contact)	1		Protected against vertically dripping water (condensation)	01		Impact energy : 0.15 J
2	∅ 12 mm 	Protected against solid objects of over 12 mm (eg : finger)	2		Protected against water dripping up to 15° from the vertical	02		Impact energy : 0.20 J
3	∅ 2.5 mm 	Protected against solid objects of over 2.5 mm (eg : tools, wire)	3		Protected against rain falling at up to 60° from the vertical	03		Impact energy : 0.37 J
4	∅ 1 mm 	Protected against solid objects of over 1 mm (eg : small tools, thin wire)	4		Protected against water splashes from all directions	04		Impact energy : 0.50 J
5		Protected against dust (no deposits of harmful material)	5		Protected against jets of water from all directions	05		Impact energy : 0.70 J
6		Protected against entry of dust	6		Protected against jets of water comparable to heavy seas	06		Impact energy : 1 J
			7		Protected against the effects of immersion to depths of between 0.15 and 1 m	07		Impact energy : 2 J
			8		Protected against the effects of prolonged immersion under pressure	08		Impact energy : 5 J
						09		Impact energy : 10 J
						10		Impact energy : 20 J

Example:

IP 55 machine

IP : Index of protection

- 5 : Machine protected against dust and accidental contact.
Test result: **no dust enters** in harmful quantities, no risk of direct contact with rotating parts. The test will last for 2 hours.
- .5 : Machine protected against jets of water from all directions from hoses at 3 m distance with a flow rate of 12.5 l/min at 0.3 bar.
The test will last for 3 minutes.
Test result: **no damage from water** projected onto the machine.

3-phase TEFV induction motors LS aluminium alloy frame Environment

B2 - Environmental limitations

B2.1 - NORMAL OPERATING CONDITIONS

a / According to IEC 60034-1, motors can operate in the following normal conditions:

- ambient temperature within the range - 16 and + 40 °C
- altitude less than 1000 m
- atmospheric pressure: 1050 hPa (mbar) = (750 mm Hg)

b / Power correction factor:

For operating conditions outside these limits, apply the power correction coefficient shown in the chart on the right **which maintains the thermal reserve**, as a function of the altitude and ambient temperature.

B2.2 - NORMAL STORAGE CONDITIONS

Machines should be stored at an ambient temperature between -16 and + 40 °C and a relative humidity of less than 90%.

For restarting, see commissioning manual.

B2.3 - RELATIVE AND ABSOLUTE HUMIDITY

Measuring the humidity:

Humidity is usually measured by the “wet and dry bulb thermometer” method.

Absolute humidity, calculated from the readings taken on the two thermometers, can be determined using the chart on the right. The chart also provides relative humidity figures.

To determine the humidity correctly, a good air flow is required for stable readings, and accurate readings must be taken on the thermometers.

During the construction of aluminium motors, the materials of the various components which are in contact with one another are selected so as to minimise deterioration by galvanic effect. The voltages in the metal combinations used (cast iron-steel; cast iron-aluminium; steel-aluminium; steel-tin) are too low to cause deterioration.

B2.4 - DRAIN HOLES

Holes are provided at the lowest points of the enclosure, depending on the operating position (IM etc) to drain off any moisture that may have accumulated inside during cooling of the machine.

The holes may be sealed in various ways:

- standard: with plastic plugs,
- on request: with screws, siphon or plastic ventilator.

▼ Correction coefficient table

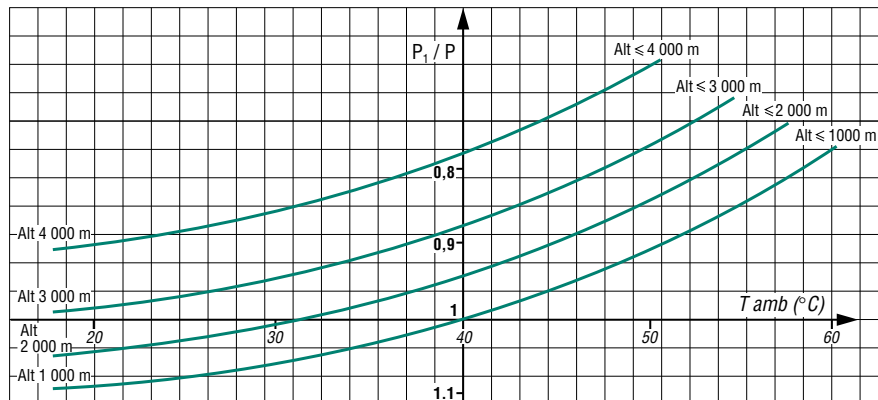

Note: the output power can only be corrected upwards once the ability of the motor to start the load has been checked.

In temperate climates, relative humidity is generally between 50 and 70%. For the relationship between relative humidity and motor impregnation, especially where humidity and temperature are high, see table on next page. ▼

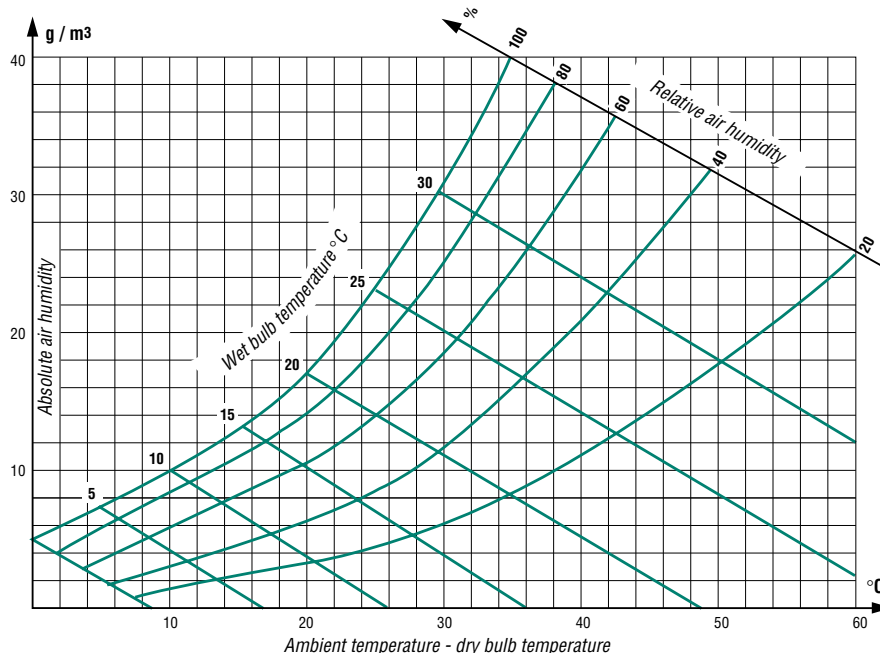

B2.5 - DRIP COVERS

For machines operating outdoors, with the drive shaft downwards, drip covers are recommended.

This is an option and should be specified on the order if required.

The dimensions are given in the dimensions tables. (Page 111, section G2).

3-phase TEFV induction motors LS aluminium alloy frame Environment

B3 - Impregnation and enhanced protection



B3.1 - NORMAL ATMOSPHERIC PRESSURE (750 mm Hg)

The selection table below can be used to find the method of manufacture best suited to particular environments in which temperature and relative humidity show large degrees of variation (see relative and absolute humidity calculation method, on preceding page).

The symbols used refer to permutations of components, materials, impregnation methods and finishes (varnish or paint).

The protection of the winding is generally described by the term "tropicalization".

For high humidity environments, we recommend that the windings are pre-heated (see section B4.1).

Relative humidity	Frame size 56 to 132			Frame size 160 to 315		Influence on manufacture
	RH < 90%	RH 90 to 98%*	RH > 98%*	RH ≤ 95%	RH > 95%*	
Ambient Temperature						 Increased derating
$\theta < -40\text{ °C}$	ask for estimate (quotation)	ask for estimate (quotation)	ask for estimate (quotation)	ask for estimate (quotation)	ask for estimate (quotation)	
-16 to +40 °C	T Standard or T0	TR Standard or TR0	TC Standard or TC0	T Standard or T0	TC Standard or TC0	
-40 to +40 °C	T1	TR1	TC1	T1	TC1	
-16 to +65 °C	T2	TR2	TC2	T2	TC2	
+65 to +90 °C	T3**	TR3**	TC3**	ask for estimate (quotation)	ask for estimate (quotation)	
$\theta > +90\text{ °C}$	ask for estimate (quotation)	ask for estimate (quotation)	ask for estimate (quotation)	ask for estimate (quotation)	ask for estimate (quotation)	
Plate mark	T	TR	TC	T	TC	
Influence on construction	 Increased protection of windings			 Increased protection of windings		

* Atmosphere without high levels of condensation

** Bearing life calculated for 5000 running hours (section C3, page 28). For longer times, please consult Leroy Somer.

Standard manufacture

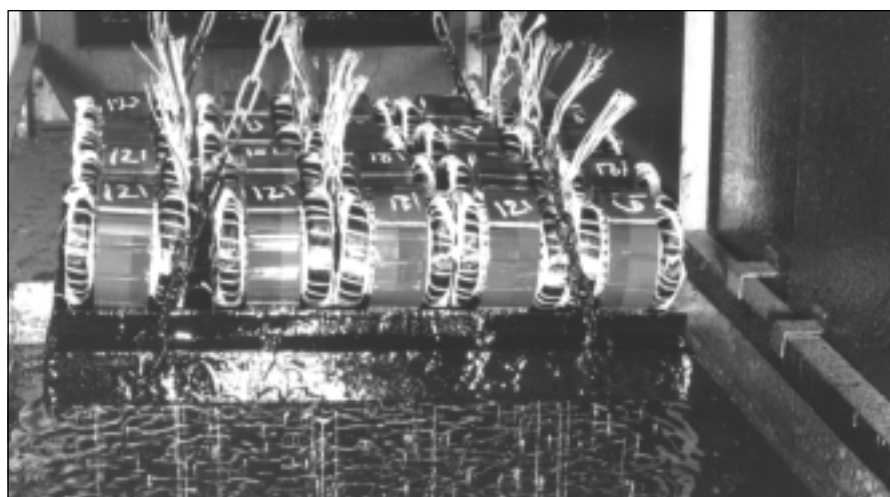

3-phase TEFV induction motors LS aluminium alloy frame Environment

B3 - Impregnation and enhanced protection

B3.2 - INFLUENCE OF ATMOSPHERIC PRESSURE

As atmospheric pressure decreases, air particles rarefy and the environment becomes increasingly conductive.

The curve below shows the increase in isolation distance required, according to atmospheric pressure.

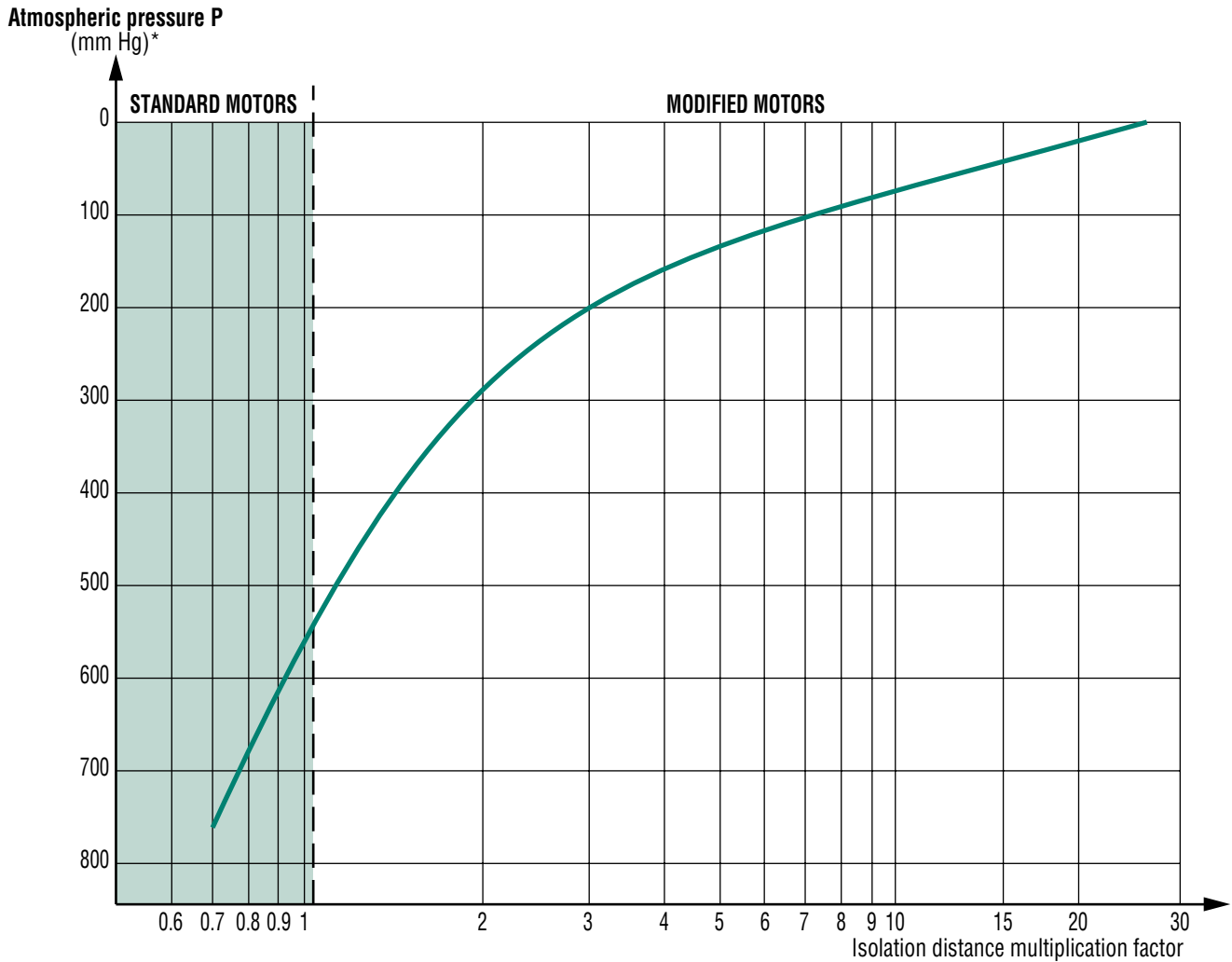

* 1 mm Hg = 1.333 mbar = 1.333×10^2 Pa

Solutions for permanent applications: offers based on specification

- P > 550 mm Hg: Standard impregnation according to previous table - Possible derating or forced ventilation.
- P > 200 mm Hg: Coating of bearings - Flying leads up to a zone at P ~ 750 mm Hg - Derating to take account of insufficient ventilation - Forced ventilation.
- P < 200 mm Hg: Special manufacture based on specification.

In all cases, these problems should be resolved by a special contract worked out on the basis of a specification.

3-phase TEFV induction motors LS aluminium alloy frame Environment

B4 - Heaters

B4.1 - SPACE HEATERS

Severe climatic conditions, e.g. $T_{amb} < -40^{\circ}\text{C}$, $\text{RH} > 95\%$ etc, may require the use of space heaters (fitted to the motor windings) which serve to maintain the average temperature of the motor, provide trouble-free starting, and eliminate problems caused by condensation (loss of insulation).

The heater supply wires are brought out to a terminal block in the motor terminal box. The heaters must be switched off while the motor is running.

Motor type	No. of poles	Power: P(W)
LS 80	2 - 4 - 6 - 8	10
LS 90 to LS 132	2 - 4 - 6 - 8	25
LS 160 to LS 180	2 - 4 - 6 - 8	50
LS 200 to LS 225	2 - 4 - 6 - 8	50
LS 250	2 4 - 6 - 8	50 80
LS 280 to LS 315	2 4 - 6 - 8	80 100

The space heaters use 200/240V, single-phase, 50 or 60 Hz.

B4.2 - D.C. INJECTION

An alternative to the use of space heaters is to inject direct current into two of the phases wired in series from a D.C. voltage source which can give the total power indicated in the table above. This method can only be used on motors of less than 10 kW.

This is easily calculated: if R is the resistance of the windings in series, the D.C. voltage will be given by the equation (Ohm's law):

$$U_{(V)} = \sqrt{P_{(W)} \cdot R_{(\Omega)}}$$

Resistance should be measured with a micro-ohmmeter.



B4.3 - A.C. INJECTION

A single-phase A.C. voltage (from 10 to 15% of rated voltage), can be used between 2 phases placed in series.

This method can be used on the whole LS range.

3-phase TEFV induction motors LS aluminium alloy frame Environment

B5 - External finish

LEROY-SOMER motors are protected with a range of surface finishes.
The surfaces receive appropriate special treatments, as shown below.

**LS motors conform
to System Ia**

Preparation of surfaces

SURFACE	PARTS	TREATMENT
Cast iron	End shields	Shot blasting + Primer
Steel	Accessories	Phosphatization + Primer
	Terminal boxes - Fan covers	Electrostatic painting or Epoxy powder
Aluminium alloy	Housing - Terminal boxes	Shot blasting
Polymer	Fan covers - Terminal boxes Ventilation grilles	None, but must be free from grease, casting-mould coatings, and dust which would affect paint adhesion

Definition of atmospheres

An atmosphere is said to be harsh when components are attacked by bases, acids or salts. It is said to be corrosive when components are attacked by oxygen.

Painting systems

PRODUCTS	ATMOSPHERE	SYSTEM	APPLICATIONS	RESISTANCE TO SALINE MIST standard NFX 41002
LEROY-SOMER Motors	Clean, dry (indoors, rural or industrial)	Ia	1 coat polyurethane finish 25/30 µm	72 hours
	Moderately corrosive: humid, and outdoors (temperate climate)	IIa	1 base coat Epoxy 35/40 µm 1 coat polyurethane finish 25/30 µm	150 hours
	Corrosive: coastal, very humid (tropical climate)	IIIa	1 base coat Epoxy before assembly on internal and external surfaces of cast iron parts 35/40 µm 1 intermediate coat Epoxy 35/40 µm 1 coat polyurethane finish 25/30 µm	300 hours
	Painting system for water and environments not in contact with chlorinated or sulphurous products	IIIe	1 base coat Epoxy 50/60 µm 1 intermediate coat Epoxy 50/60 µm 1 coat Epoxy finish 35/40 µm	500 hours

System Ia is for moderate climates and System IIa is for general climates as defined in standard NFC 20 000 (or IEC 721.2.1).
Exposure to saline mist under the terms of standard NFX 41002 (5% of NaCl at 6 < PH < 7.5 at 35° and 1 bar).

LEROY-SOMER standard paint colour reference:

RAL 6000

3-phase TEFV induction motors LS aluminium alloy frame Environment

B6 - Interference suppression

Airborne interference

Emission

For standard motors, the housing acts as an electromagnetic screening, reducing electromagnetic emissions measured at 0.25 metres from the motor to approximately 5 gauss (5×10^{-4} T).

However, electromagnetic emissions may be noticeably reduced by a special construction of aluminium alloy end shields and a stainless steel shaft.

Immunity

The construction of motor housings (especially the finned aluminium alloy frames) isolates external electromagnetic sources to the extent that any field penetrating the casing and magnetic circuit will be too weak to interfere with the operation of the motor.

Power supply interference

The use of electronic systems for starting, speed control or power supply can create harmonics on the supply lines which may interfere with the operation of machines. These phenomena are taken into account in determining the machine dimensions, which act as quenching chokes in this respect.

The IEC 61000 standard, currently in preparation, will define permissible rejection and immunity rates: only then will machines for general distribution (especially single-phase motors and commutator motors) have to be fitted with suppression systems.

Three-phase squirrel cage machines do not in themselves produce interference of this type. Mains connection equipment (contactors) may, however, need interference protection.

Application of Directive 89-336 modified by Directives 92-31 and 93-68 concerning electromagnetic compatibility (EMC).

a - for motors only

According to amendment 1 of IEC 60034-1, induction motors are not transmitters and do not produce interference (via carried or airborne signals) and therefore conform inherently to the essential requirements of the EMC directives.

b - for motors supplied by inverters (at fixed or variable frequency)

In this case, the motor is only a sub-assembly of a device which the system builder must ensure conforms to the essential requirements of the EMC directives.

Application of the Low Voltage Directive 73-23 EEC modified by Directive 93/68

All motors have been subject to this directive since 1 July 1997. The main requirements concern the protection of people, animals and property against risks caused by operation of the motors (see the commissioning and maintenance manual for precautions to be taken).

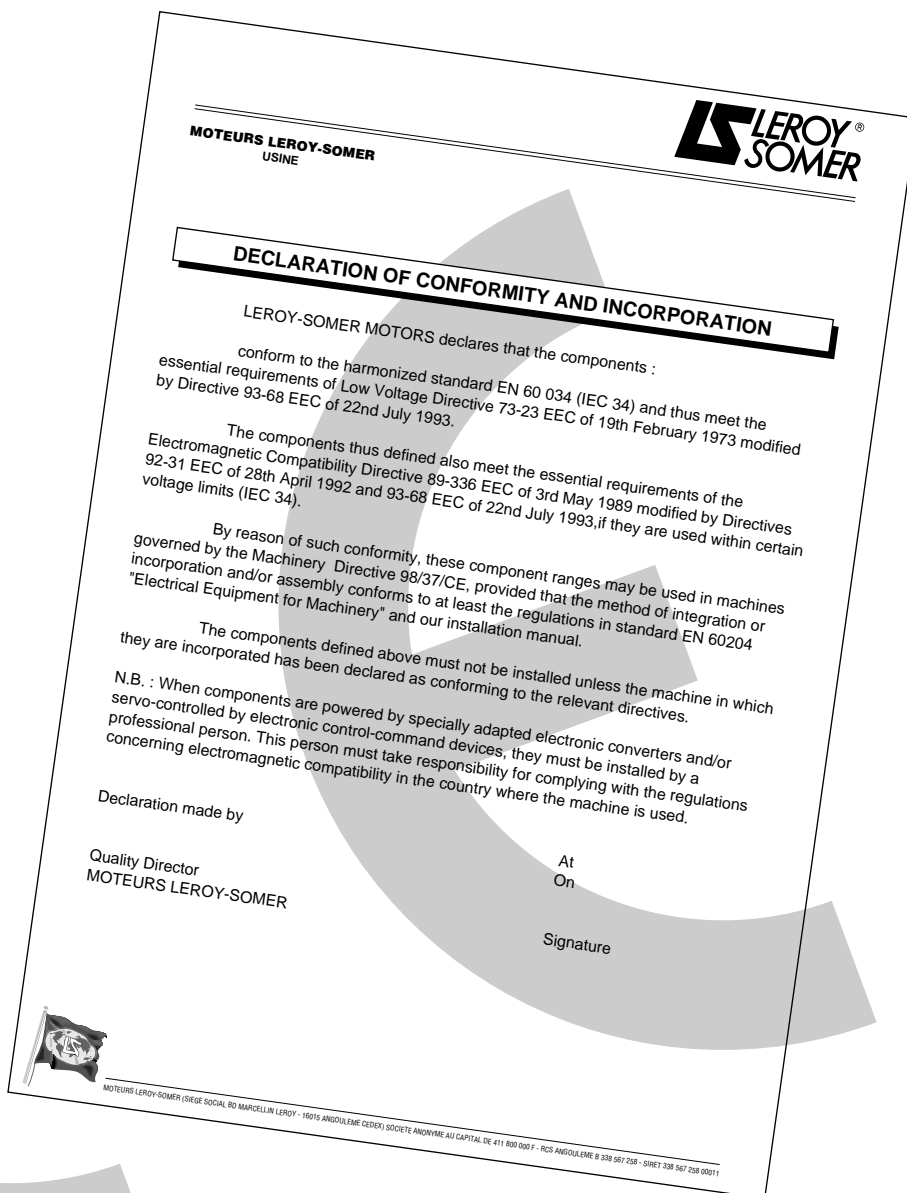

CE product marking

The fact that motors conform to the essential requirements of the Directives is shown by the CE mark on their nameplates and/or packaging and documentation.

3-phase TEFV induction motors LS aluminium alloy frame Construction

C1 - Component parts

Description of standard LS 3-phase motors

Component	Materials	Remarks
1 Housing with cooling fins	Aluminium alloy	<ul style="list-style-type: none"> - with integral or screw-on feet, or without feet - die-cast for frame size ≤ 180 - gravity die-cast for frame size ≥ 200 <ul style="list-style-type: none"> • 4 or 6 fixing holes for housings with feet • lifting rings for frame size ≥ 132 M, optional for 132 S and 112 - earth terminal (optional)
2 Stator	Insulated low-carbon magnetic steel laminations Electroplated copper	<ul style="list-style-type: none"> - low carbon content guarantees long-term lamination pack stability - welded packs - semi-enclosed slots - class F insulation
3 Rotor	Insulated low-carbon magnetic steel laminations Aluminium (A5L)	<ul style="list-style-type: none"> - inclined cage bars - rotor cage pressure die-cast in aluminium (or alloy for special applications) - shrink-fitted to shaft - rotor balanced dynamically, class N, 1/2 key
4 Shaft	Steel	<ul style="list-style-type: none"> - for frame size < 132: <ul style="list-style-type: none"> • shaft end fitted with screw and washer • closed keyway - for frame size ≥ 132: <ul style="list-style-type: none"> • tapped hole • open keyway
5 End shields	Aluminium alloy Cast iron	<ul style="list-style-type: none"> - LS 56 - 63 - 71 drive end and non drive end - LS 80 - 90 non drive end - LS 80 - 90 drive end (optional for LS 80 and 90 at non drive end) - LS 100 to 315 drive end and non drive end
6 Bearings and lubrication		<ul style="list-style-type: none"> - ball bearings - type 2RS 'greased for life' from LS 56 to LS 71 inclusive - types ZZ 'greased for life' from LS 80 to LS 180 inclusive - semi-protected or open type for frame size 200 - open type, regreasable from 225 upwards - bearings preloaded at non drive end
7 Labyrinth seal Lipseals	Plastic or steel Synthetic rubber	<ul style="list-style-type: none"> - lipseal or deflector at drive end for all flange mounted motors - lipseal, deflector or labyrinth seal for foot mounted motors
8 Fan	Composite material or aluminium alloy	<ul style="list-style-type: none"> - 2 directions of rotation: straight blades
9 Fan cover	Composite material or pressed steel	<ul style="list-style-type: none"> - fitted, on request, with a drip cover for operation in vertical position, shaft end facing down.
10 Terminal box	Composite material or aluminium alloy	<ul style="list-style-type: none"> - IP 55 - can be turned on, opposite side to feet - fitted with a terminal block with 6 steel terminals as standard (brass as an option) - terminal box supplied fitted with cable glands (without cable glands as an option) - 1 earth terminal in each terminal box

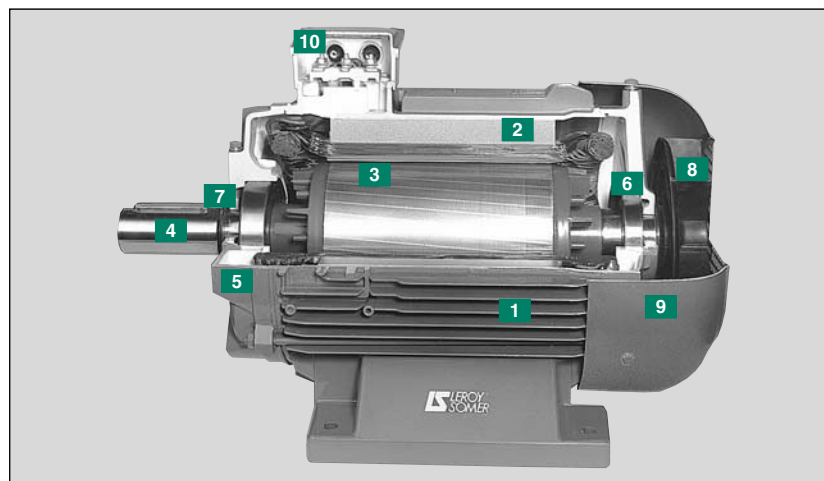

3-phase TEFV induction motors LS aluminium alloy frame Construction

C2 - Mounting arrangements

C2.1 - MOUNTING ARRANGEMENTS

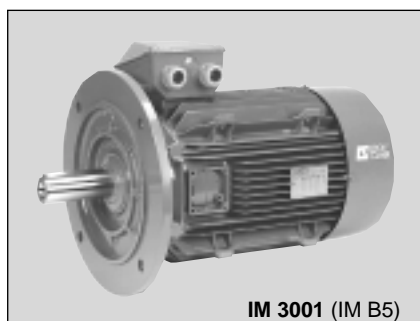
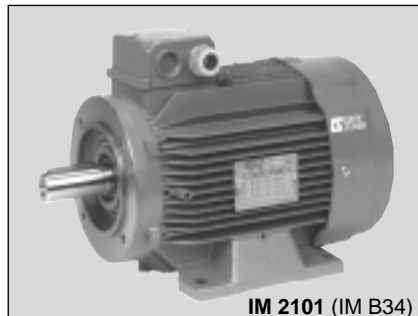

The various mounting arrangements for machines are defined in IEC 60034-7. Below is an extract from the standard which shows equivalent terms in current use.

Code formulation

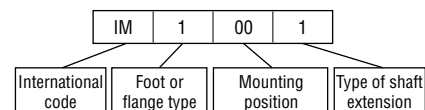

Code I	Code II
IM B 3	IM 1001
IM V 5	IM 1011
IM V 6	IM 1031
IM B 6	IM 1051
IM B 7	IM 1061
IM B 8	IM 1071
IM B 20	IM 1101
IM B 15	IM 1201
IM B 35	IM 2001
IM V 15	IM 2011
IM V 36	IM 2031
IM B 34	IM 2101
IM B 5	IM 3001
IM V 1	IM 3011
IM V 21	IM 3051
IM V 3	IM 3031
IM V 4	IM 3211
IM V 2	IM 3231
IM B 14	IM 3601
IM V 18	IM 3611
IM V 19	IM 3631
IM B 10	IM 4001
IM V 10	IM 4011
IM V 14	IM 4031
IM V 16	IM 4131
IM B 9	IM 9101
IM V 8	IM 9111
IM V 9	IM 9131
IM B 30	IM 9201
IM V 30	IM 9211
IM V 31	IM 9231

Codes I and II are interchangeable. It should however be noted that the above code list is not exhaustive and you should therefore refer to IEC 60034-7 for other designations. On the next page you will find the most common mounting arrangements with line drawings and an explanation of the standard symbols used.

Mounting options according to frame size

Some operating positions are prohibited for standard motors. Select the possible configurations for machine installation from the table below. In the case of difficulty, please consult Leroy-Somer.

Frame size	Mounting positions											
	IM 1001	IM 1051	IM 1061	IM 1071	IM 1011*	IM 1031	IM 3001	IM 3011*	IM 3031	IM 2001	IM 2011*	IM 2031
80 to 200	●	●	●	●	●	●	●	●	●	●	●	●
225 and	●	●	●	●	●	●	○	●	●	●	●	●
280 and	●	○	○	○	○	○	○	●	●	●	●	○

● : possible positions.

○ : please consult Leroy-Somer specifying the coupling method and the axial and radial loads if applicable.

* : the use of a drip cover is recommended for these mounting arrangements.

3-phase TEFV induction motors LS aluminium alloy frame Construction

C2 - Mounting arrangements

C2.2 - MOUNTINGS AND POSITIONS (IEC 60034-7)

Foot mounted motors

- all frame sizes

IM 1001 (IM B3)
- Horizontal shaft
- Feet on floor

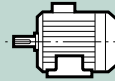

IM 1071 (IM B8)
- Horizontal shaft
- Feet on top



IM 1051 (IM B6)
- Horizontal shaft
- Wall mounted with feet on left hand side when viewed from drive end

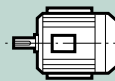

IM 1011 (IM V5)
- Vertical shaft facing down
- Feet on wall



IM 1061 (IM B7)
- Horizontal shaft
- Wall mounted with feet on right hand side when viewed from drive end

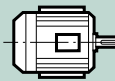

IM 1031 (IM V6)
- Vertical shaft facing up
- Feet on wall

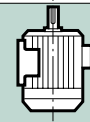

(FF) flange mounted motors

- all frame sizes
(except IM 3001 limited to frame size 225)

IM 3001 (IM B5)
- Horizontal shaft

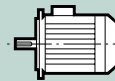

IM 2001 (IM B35)
- Horizontal shaft
- Feet on floor

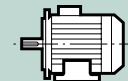

IM 3011 (IM V1)
- Vertical shaft facing down

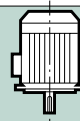

IM 2011 (IM V15)
- Vertical shaft facing down
- Feet on wall



IM 3031 (IM V3)
- Vertical shaft facing up



IM 2031 (IM V36)
- Vertical shaft facing up
- Feet on wall

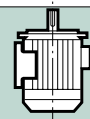

(FT) face mounted motors

- all frame sizes ≤ 132 mm

IM 3601 (IM B14)
- Horizontal shaft

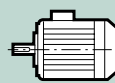

IM 2101 (IM B34)
- Horizontal shaft
- Feet on floor

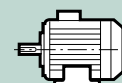

IM 3611 (IM V18)
- Vertical shaft facing down



IM 2111 (IM V58)
- Vertical shaft facing down
- Feet on wall



IM 3631 (IM V19)
- Vertical shaft facing up

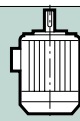

IM 2131 (IM V69)
- Vertical shaft facing up
- Feet on wall

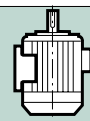

Motors without drive end shield

Warning: the protection (IP) specified on the IM B9 and IM B15 motor plates is provided by the customer when the motor is assembled.

IM 9101 (IM B9)
- Threaded tie rods
- Horizontal shaft

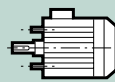

IM 1201 (IM B15)
- Foot mounted and threaded tie rods
- Horizontal shaft

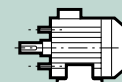

3-phase TEFV induction motors LS aluminium alloy frame Construction

C3 - Bearings and lubrication

C3.1 - TYPES OF BALL BEARING AND STANDARD FITTING ARRANGEMENTS

		Horizontal shaft	Vertical shaft	
			Shaft facing down	Shaft facing up
Mounting arrangement		B3 / B6 / B7 / B8	V5	V6
Foot mounted motors	standard mounting	The DE bearing is: - located at DE for frame ≤ 180 - locked at DE for frame ≥ 200	The DE bearing is: - located at DE for frame ≤ 180 - locked at DE for frame ≥ 200	The DE bearing is: - locked at DE for frame ≥ 100
	on request	DE bearing locked	DE bearing locked	
Mounting arrangement		B5 / B35 / B14 / B34	V1 / V15 / V18 / V58	V3 / V36 / V19 / V69
Flange mounted (or foot and flange) motors	standard mounting	The DE bearing is locked	The DE bearing is locked	The DE bearing is locked

Important: When ordering, state correct mounting type and position (see section C1).

Motor		No. of poles	Standard mounting			
Frame/Type	LEROY-SOMER Designation		Non drive end bearing (N.D.E.)	Drive end bearing (D.E.)	Assembly diagram reference	
				Foot mounted motors	Flange mounted (or foot and flange) motors	
56 L	LS 56 L	2 ; 4 ; 6 ; 8	6201 2RS C3	6201 2RS C3	1	2
63 M	LS 63 M	2 ; 4 ; 6 ; 8	6201 2RS C3	6202 2RS C3	1	2
71 M	LS 71 M	2 ; 4 ; 6 ; 8	6201 2RS C3	6202 2RS C3	1	2
80 L	LS 80 L	2 ; 4	6203 ZZ CN	6204 ZZ C3	3	4
80 L	LS 80 L	6 ; 8	6203 CN	6204 ZZ C3	5	6
90 S/L	LS 90 S - SL - L	2 ; 4	6204 ZZ C3	6205 ZZ C3	3	4
90 L	LS 90 S - SL - L	6 ; 8	6204 ZZ C3	6205 ZZ C3	5	6
100 L	LS 100 L	2 ; 4 ; 6 ; 8	6205 ZZ C3	6206 ZZ C3	5	6
112 M	LS 112 M - MG - MR	2 ; 4 ; 6 ; 8	6205 ZZ C3	6206 ZZ C3	5	6
112 M	LS 112 MU	2 ; 4 ; 6 ; 8	6206 ZZ C3	6206 ZZ C3	5	6
132 S	LS 132 S	2 ; 4 ; 6 ; 8	6206 ZZ C3	6208 ZZ C3	5	6
132 M	LS 132 M - SM	2 ; 4 ; 6 ; 8	6207 ZZ C3	6308 ZZ C3	5	6
160 M	LS 160 MP	2 ; 4	6208 ZZ C3	6309 ZZ C3	7	7
160 M	LS 160 M	6 ; 8	6210 ZZ C3	6309 ZZ C3	10 (12 for V6)	14
160 L	LS 160 LR	4	6308 ZZ C3	6309 ZZ C3	7	7
160 L	LS 160 L	2 ; 6 ; 8	6210 ZZ C3	6309 ZZ C3	10 (12 for V6)	14
160 L	LS 160 LU	2-speed	6210 ZZ C3	6309 ZZ C3	10 (12 for V6)	14
180 M	LS 180 MT	2 ; 4	6210 ZZ C3	6310 ZZ C3	10 (12 for V6)	14
180 L	LS 180 LR	4	6210 ZZ C3	6310 ZZ C3	10 (12 for V6)	14
180 L	LS 180 L	6 ; 8	6212 Z C3	6310 Z C3	9 (11 for V6)	18
180 L	LS 180 LU	2-speed	6212 Z C3	6310 Z C3	9 (11 for V6)	18
200 L	LS 200 LT	2 ; 4 ; 6	6212 Z C3	6312 C3	11	18
200 L	LS 200 L	2 ; 6 ; 8	6214 Z C3	6312 C3	11	18
200 L	LS 200 LU	2-speed	6312 C3	6312 C3	15	20
225 S	LS 225 ST	4 ; 8	6214 Z C3	6313 C3	13	19
225 M	LS 225 MT	2	6214 Z C3	6313 C3	13	19
225 M	LS 225 MR	2 ; 4 ; 6 ; 8	6312 C3	6313 C3	15	20
225 M	LS 225 MG	2-speed	6216 C3	6314 C3	16	16
250 M	LS 250 MZ	2	6312 C3	6313 C3	15	20
250 M	LS 250 ME	4 ; 6 ; 8	6216 C3	6314 C3	16	16
280 S	LS 280 SC - MC	2	6216 C3	6314 C3	16	16
280 S	LS 280 SC	4 ; 6 ; 8	6216 C3	6316 C3	16	16
280 S	LS 280 SK - MK	2-speed	6317 C3	6317 C3	17	17
280 M	LS 280 MD	4 ; 8	6218 C3	6316 C3	16	16
315 S	LS 315 SP	2	6317 C3	6317 C3	17	17
315 S	LS 315 SP	4 ; 6 ; 8	6317 C3	6320 C3	17	17
315 M	LS 315 MP - MR	2	6317 C3	6317 C3	17	17
315 M	LS 315 MP - MR	4 ; 6 ; 8	6317 C3	6320 C3	17	17

3-phase TEFV induction motors LS aluminium alloy frame Construction

C3 - Bearings and lubrication

C3.1.1 - Bearing assembly diagrams

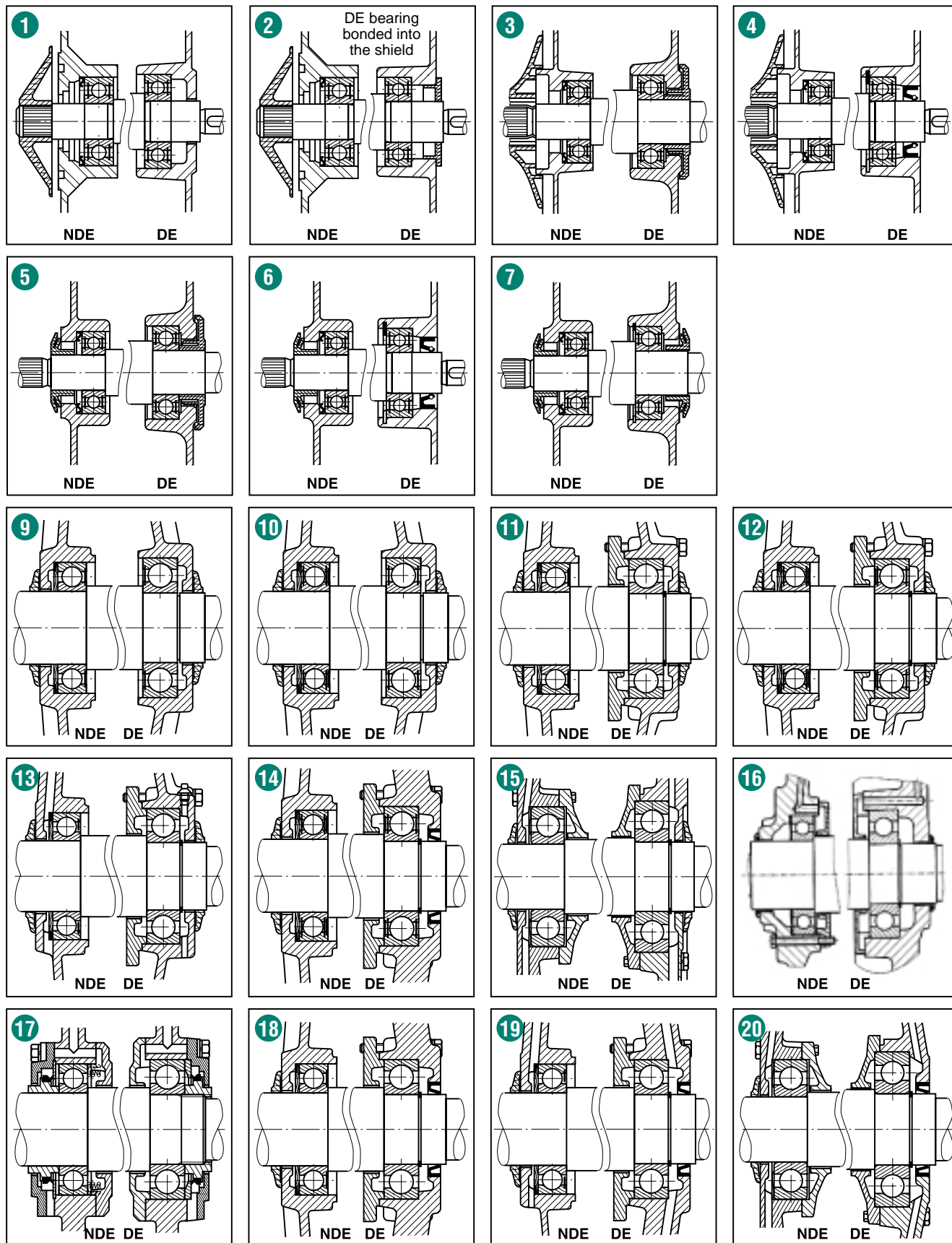

3-phase TEFV induction motors LS aluminium alloy frame Construction

C3 - Bearings and lubrication

C3.2 - AXIAL LOADS

C3.2.1 - Permissible axial load (in daN) on main shaft extension for standard bearing assembly

Horizontal motor

Nominal lifetime L_{10h}
of bearings: 25,000 hours



Motor		2 poles N = 3000 min ⁻¹		4 poles N = 1500 min ⁻¹		6 poles N = 1000 min ⁻¹		8 poles N = 750 min ⁻¹	
Frame size	Type	→	←	→	←	→	←	→	←
		IM B3 / B6 IM B7 / B8 IM B5 / B35 IM B14 / B34	IM B3 / B6 IM B7 / B8 IM B5 / B35 IM B14 / B34	IM B3 / B6 IM B7 / B8 IM B5 / B35 IM B14 / B34	IM B3 / B6 IM B7 / B8 IM B5 / B35 IM B14 / B34	IM B3 / B6 IM B7 / B8 IM B5 / B35 IM B14 / B34	IM B3 / B6 IM B7 / B8 IM B5 / B35 IM B14 / B34	IM B3 / B6 IM B7 / B8 IM B5 / B35 IM B14 / B34	IM B3 / B6 IM B7 / B8 IM B5 / B35 IM B14 / B34
56	LS 56 L	7	(28)*	14	(35)*	17	(38)*	18	(39)*
63	LS 63 M	13	(34)*	18	(39)*	26	(47)*	32	(53)*
71	LS 71 L	13	(34)*	18	(39)*	26	(47)*	32	(53)*
80	LS 80 L	23	(61)*	37	(75)*	45	(83)*	55	(93)*
90	LS 90 SR	19	(69)*	35	(85)*	44	(94)*	55	(105)*
90	LS 90 S	19	(69)*	35	(85)*	44	(94)*	55	(105)*
90	LS 90 L	19	(69)*	35	(85)*	44	(94)*	55	(105)*
100	LS 100 L	34	(90)*	57	(113)*	68	(124)*	83	(139)*
112	LS 112 M*	32	(88)*	46	(102)*	63	(119)*	78	(134)*
132	LS 132 S	59	(137)*	92	(170)*	114	(192)*	-	-
132	LS 132 M	86	(188)*	125	(227)*	159	(261)*	192	(294)*
160	LS 160 M	-	-	-	-	237	(337)*	268	(368)*
160	LS 160 MP	147	(227)*	197	(277)*	-	-	-	-
160	LS 160 LR	-	-	188	(278)*	-	-	-	-
160	LS 160 L	131	(231)*	-	-	219	(319)*	249	(349)*
180	LS 180 MT	159	(259)*	207	(307)*	-	-	-	-
180	LS 180 LR	-	-	193	(293)*	-	-	-	-
180	LS 180 L	-	-	-	-	270	(318)*	318	(366)*
200	LS 200 LT	255	303	312	360	372	420	-	-
200	LS 200 L	247	313	-	-	366	432	455	521
225	LS 225 ST	-	-	366	432	-	-	501	567
225	LS 225 MT	278	344	-	-	-	-	-	-
225	LS 225 MR	-	-	350	413	370	433	477	540
250	LS 250 MZ	275	338	-	-	-	-	-	-
250	LS 250 ME	-	-	392	462	451	521	523	593
280	LS 280 SC	294	364	464	534	538	608	627	697
280	LS 280 MC	291	361	-	-	524	594	-	-
280	LS 280 MD	-	-	437	507	-	-	569	657
315	LS 315 SP	500	320	790	610	864	684	1012	832
315	LS 315 MP	487	307	762	582	821	641	-	-
315	LS 315 MR	472	292	743	563	761	581	935	755

()* The axial loads shown above for IM B3 / B6 / B7 / B8 with frame size ≤ 180 are the permissible axial loads for locked DE bearings (non-standard assembly, special order).

* Also applies to LS 112 MG and MU.

3-phase TEFV induction motors LS aluminium alloy frame Construction

C3 - Bearings and lubrication

C3.2.1 - Permissible axial load (in daN) on main shaft extension for standard bearing assembly

Vertical motor
Shaft facing down

Nominal lifetime L_{10h}
of bearings: 25,000 hours



Motor		2 poles N = 3000 min ⁻¹		4 poles N = 1500 min ⁻¹		6 poles N = 1000 min ⁻¹		8 poles N = 750 min ⁻¹	
Frame size	Type	↓	↑	↓	↑	↓	↑	↓	↑
		IM V5 IM V1 / V15 IM V18 / V58..	IM V5 IM V1 / V15 IM V18 / V69..	IM V5 IM V1 / V15 IM V18 / V69..	IM V5 IM V1 / V15 IM V18 / V69..	IM V5 IM V1 / V15 IM V18 / V69..	IM V5 IM V1 / V15 IM V18 / V69..	IM V5 IM V1 / V15 IM V18 / V69..	IM V5 IM V1 / V15 IM V18 / V69..
56	LS 56 L	6	(24)*	13	(36)*	16	(39)*	19	(40)*
63	LS 63 M	11	(36)*	16	(41)*	24	(49)*	30	(55)*
71	LS 71 L	11	(36)*	16	(41)*	24	(49)*	30	(55)*
80	LS 80 L	22	(63)*	35	(79)*	42	(89)*	52	(99)*
90	LS 90 SR	17	(73)*	31	(91)*	41	(100)*	52	(111)*
90	LS 90 S	17	(73)*	31	(91)*	41	(100)*	52	(111)*
90	LS 90 L	17	(73)*	31	(91)*	41	(100)*	52	(111)*
100	LS 100 L	32	(94)*	54	(119)*	64	(131)*	79	(146)*
112	LS 112 M*	29	(93)*	41	(111)*	57	(129)*	72	(144)*
132	LS 132 S	51	(149)*	83	(185)*	105	(207)*	-	-
132	LS 132 M	73	(207)*	110	(251)*	140	(291)*	176	(321)*
160	LS 160 M	-	-	-	-	213	(376)*	245	(408)*
160	LS 160 MP	129	(245)*	177	(297)*	-	-	-	-
160	LS 160 LR	-	-	165	(301)*	-	-	-	-
160	LS 160 L	111	(261)*	-	-	191	(370)*	224	(397)*
180	LS 180 MT	136	(293)*	182	(353)*	-	-	-	-
180	LS 180 LR	-	-	166	(345)*	-	-	-	-
180	LS 180 L	-	-	-	-	232	(385)*	279	(438)*
200	LS 200 LT	222	352	276	429	329	504	-	-
200	LS 200 L	209	370	-	-	314	521	403	606
225	LS 225 ST	-	-	314	517	-	-	443	670
225	LS 225 MT	236	408	-	-	-	-	-	-
225	LS 225 MR	-	-	292	514	310	553	414	661
250	LS 250 MZ	225	414	-	-	-	-	-	-
250	LS 250 ME	-	-	311	607	363	687	424	778
280	LS 280 SC	224	481	360	707	436	795	511	904
280	LS 280 MC	209	492	-	-	406	804	-	-
280	LS 280 MD	-	-	315	718	-	-	439	908
315	LS 315 SP	344	544	601	896	657	1018	805	1167
315	LS 315 MP	317	561	553	916	591	1034	-	-
315	LS 315 MR	278	586	506	949	508	1044	678	1215

() * The axial loads shown above for IM V5 with frame size ≤ 180 are the permissible axial loads for locked DE bearings (non-standard assembly, special order).

* Also applies to LS 112 MG and MU.

3-phase TEFV induction motors LS aluminium alloy frame Construction

C3 - Bearings and lubrication

C3.2.1 - Permissible axial load (in daN) on main shaft extension for standard bearing assembly

Vertical motor
Shaft facing up

Nominal lifetime L_{10h}
of bearings: 25,000 hours

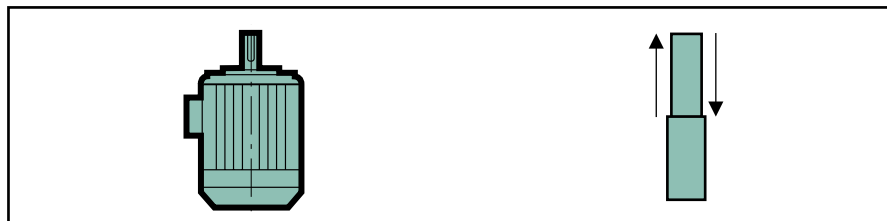

Frame size	Motor Type	2 poles N = 3000 min ⁻¹		4 poles N = 1500 min ⁻¹		6 poles N = 1000 min ⁻¹		8 poles N = 750 min ⁻¹	
		↓	↑	↓	↑	↓	↑	↓	↑
		IM V6 IM V3 / V36 IM V19 / V69..	IM V6 IM V3 / V36 IM V19 / V69..	IM V6 IM V3 / V36 IM V19 / V69..	IM V6 IM V3 / V36 IM V19 / V69..	IM V6 IM V3 / V36 IM V19 / V69..	IM V6 IM V3 / V36 IM V19 / V69..	IM V6 IM V3 / V36 IM V19 / V69..	IM V6 IM V3 / V36 IM V19 / V69..
56	LS 56 L	8	27	15	34	18	39	18	38
63	LS 63 M	15	32	20	37	28	45	34	51
71	LS 71 L	15	32	20	37	28	45	34	51
80	LS 80 L	60	25	73	41	80	51	90	61
90	LS 90 SR	67	23	81	41	91	50	102	61
90	LS 90 S	67	23	81	41	91	50	102	61
90	LS 90 L	67	23	81	41	91	50	102	61
100	LS 100 L	88	38	110	63	120	75	135	90
112	LS 112 M*	85	37	97	55	113	73	128	88
132	LS 132 S	129	71	161	107	183	129	-	-
132	LS 132 M	175	105	212	149	242	189	278	219
160	LS 160 M	-	-	-	-	313	276	345	308
160	LS 160 MP	209	165	257	217	-	-	-	-
160	LS 160 LR	-	-	(255)*	211	-	-	-	-
160	LS 160 L	211	161	-	-	291	270	324	297
180	LS 180 MT	236	193	282	253	-	-	-	-
180	LS 180 LR	-	-	266	245	-	-	-	-
180	LS 180 L	-	-	-	-	280	337	327	390
200	LS 200 LT	270	304	324	381	377	456	-	-
200	LS 200 L	275	304	-	-	380	455	469	540
225	LS 225 ST	-	-	380	451	-	-	509	604
225	LS 225 MT	302	342	-	-	-	-	-	-
225	LS 225 MR	-	-	355	451	373	490	477	598
250	LS 250 MZ	288	351	-	-	-	-	-	-
250	LS 250 ME	-	-	381	537	433	617	494	708
280	LS 280 SC	294	411	430	637	506	725	834	581
280	LS 280 MC	279	422	-	-	476	734	-	-
280	LS 280 MD	-	-	385	648	-	-	820	527
315	LS 315 SP	164	724	421	1076	477	1198	625	1347
315	LS 315 MP	137	741	373	1096	411	1214	-	-
315	LS 315 MR	98	766	326	1129	328	1224	498	1395

() * The axial loads shown above for IM V6 with frame size ≤ 180 are the permissible axial loads for locked DE bearings (non-standard assembly, special order).

* Also applies to LS 112 MG and MU.

3-phase TEFV induction motors LS aluminium alloy frame Construction

C3 - Bearings and lubrication

C3.3 - RADIAL LOADS

C3.3.1 - Permissible radial load on main shaft extension

In pulley and belt couplings, the drive shaft carrying the pulley is subjected to a radial force F_{pr} applied at a distance X (mm) from the shoulder of the shaft extension (length E).

● Radial force applied to drive shaft extension: F_{pr}

The radial force F_{pr} expressed in daN applied to the shaft extension is found by the formula.

$$F_{pr} = 1.91 \cdot 10^6 \frac{P_N \cdot k}{D \cdot N_N} \pm P_p$$

where:

P_N = rated motor power (kW)

D = external diameter of the drive pulley (mm)

N_N = rated speed of the motor (min^{-1})

k = factor depending on the type of transmission

P_p = weight of the pulley (daN)

The weight of the pulley is positive when it acts in the same direction as the tension force in the belt (and negative when it acts in the opposite direction).

Range of values for factor k (*)

- toothed belts $k = 1$ to 1.5
- V-belts $k = 2$ to 2.5
- flat belts
 - with tensioner $k = 2.5$ to 3
 - without tensioner $k = 3$ to 4

(*) A more accurate figure for factor k can be obtained from the transmission suppliers.

● Permission radial force on the drive shaft extension

The charts on the following pages indicate, for each type of motor, the radial force F_R at a distance X permissible on the drive end shaft extension, for a bearing life L_{10h} of 25,000 hours.

Note: For frame sizes ≥ 315 M, the selection charts are applicable for a motor installed with the shaft horizontal.

● Change in bearing life depending on the radial load factor

For a radial load F_{pr} ($F_{pr} \neq F_R$), applied at distance X , the bearing life L_{10h} changes, at a first approximation, in the ratio k_R , ($k_R = F_{pr} / F_R$) as shown in the chart opposite, for standard assemblies.

If the load factor k_R is greater than 1.05, you should consult our technical department, stating mounting position and direction of force before opting for a special assembly.

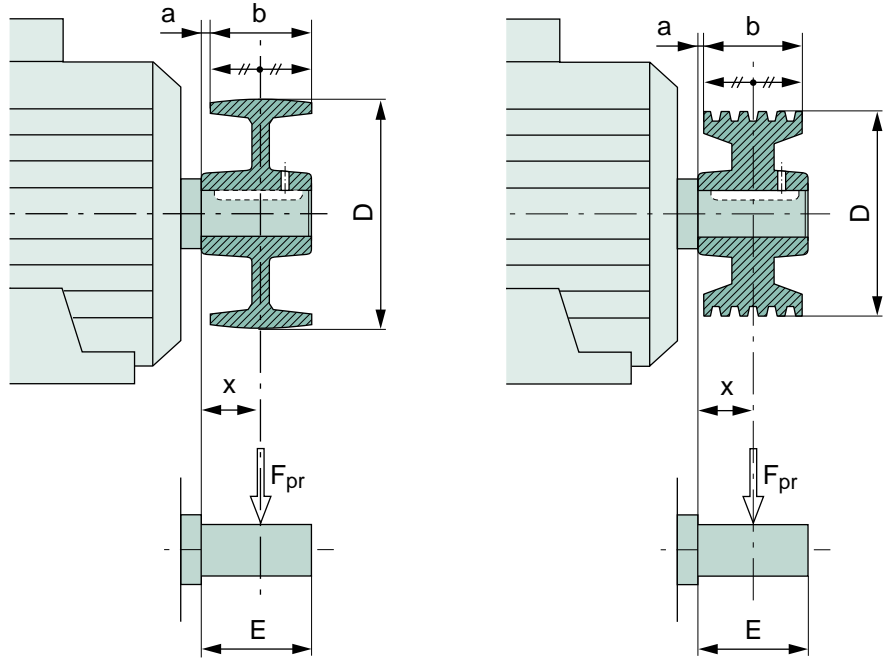

$$\left\{ \begin{array}{l} x = a + \frac{b}{2} \\ \text{where} \\ x \leq E \end{array} \right.$$

$$\left\{ \begin{array}{l} x = a + \frac{b}{2} \\ \text{where} \\ x \leq E \end{array} \right.$$

▼ Change in bearing life L_{10h} depending on the radial load factor k_R for standard assemblies.

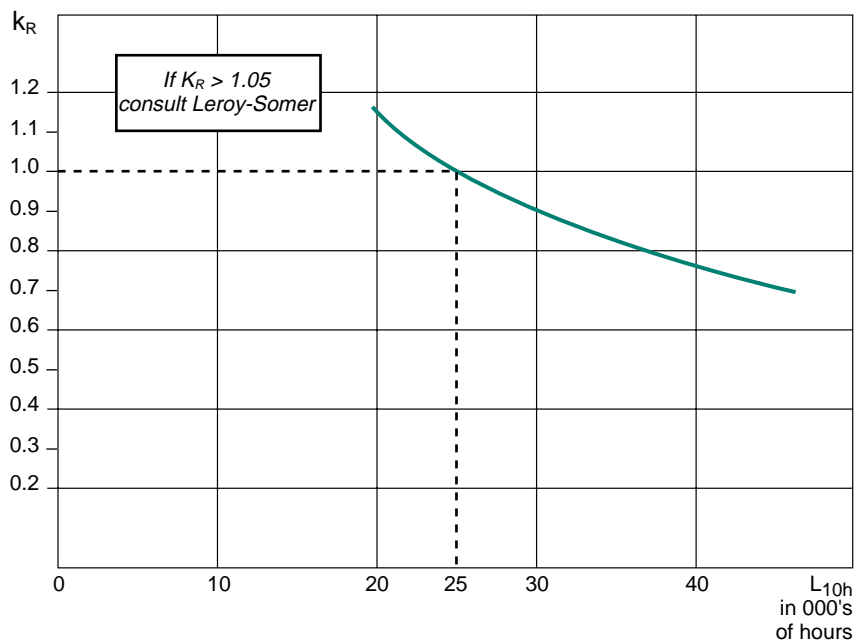

3-phase TEFV induction motors LS aluminium alloy frame Construction

C3 - Bearings and lubrication

C3.3.2 - Standard mounting

Permissible radial load on main shaft extension with a bearing life L_{10h} of 25,000 hours.

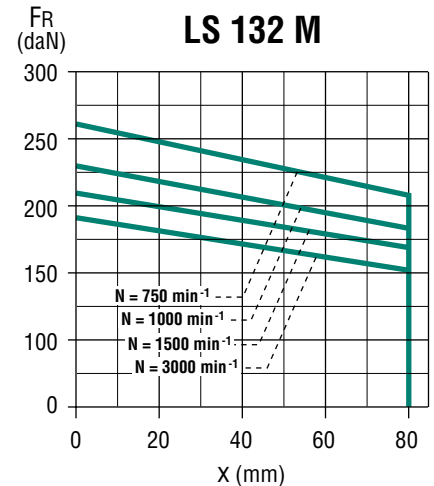
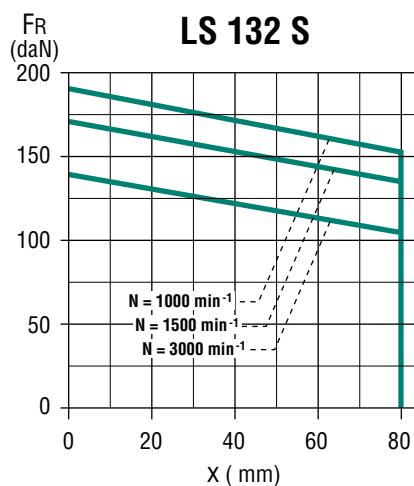
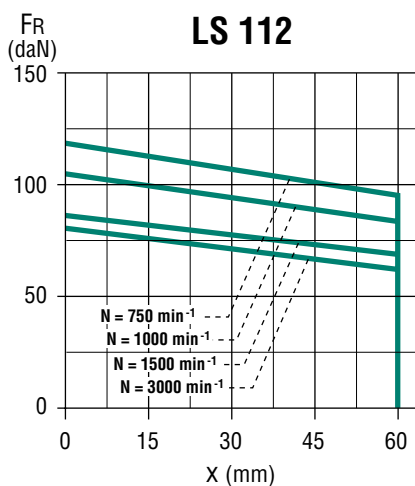
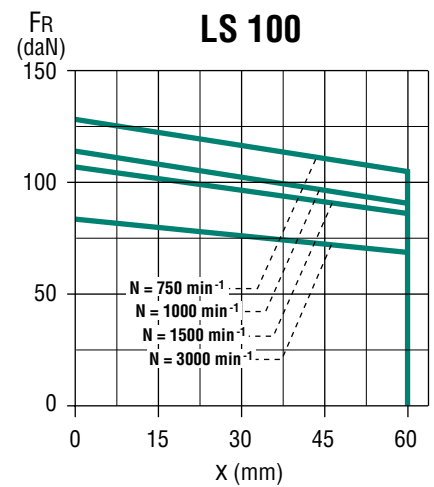
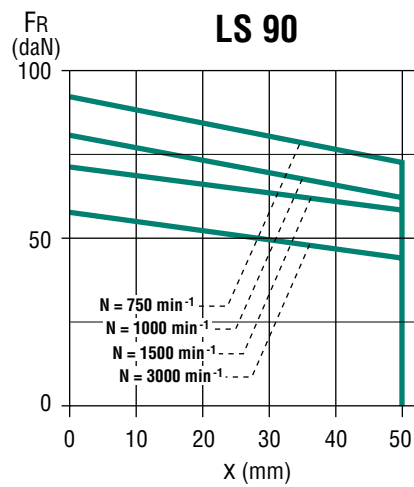
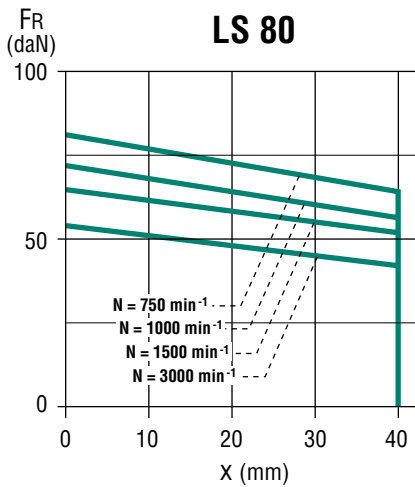
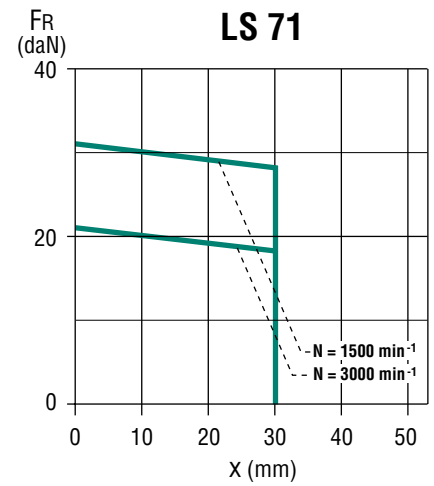
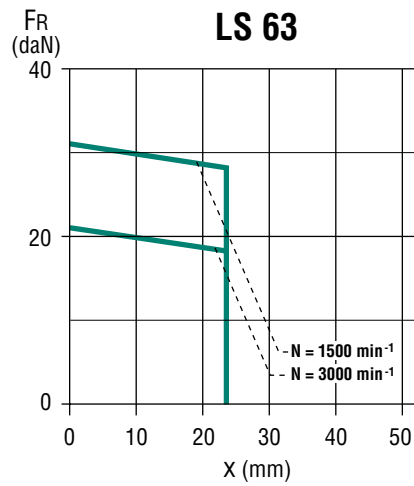
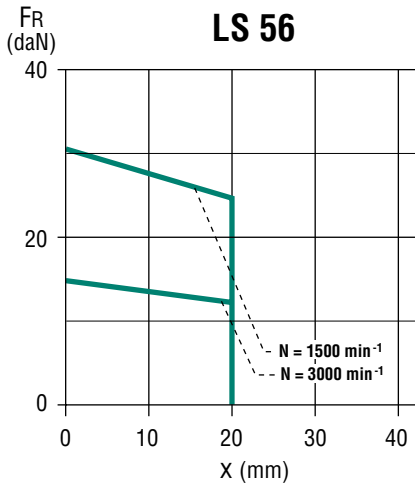

3-phase TEFV induction motors LS aluminium alloy frame Construction

C3 - Bearings and lubrication

C3.30.2 - Standard assembly

Permissible radial load on main shaft extension with a bearing life L_{10h} of 25,000 hours.

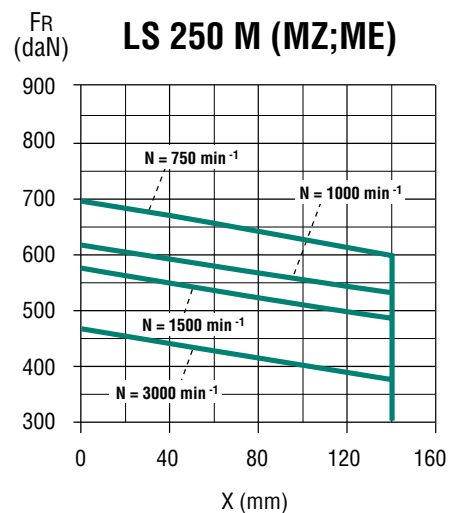
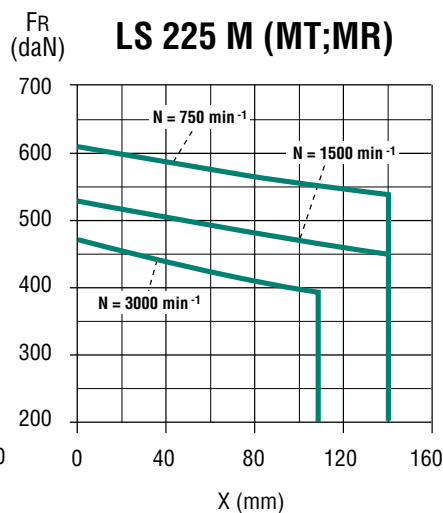
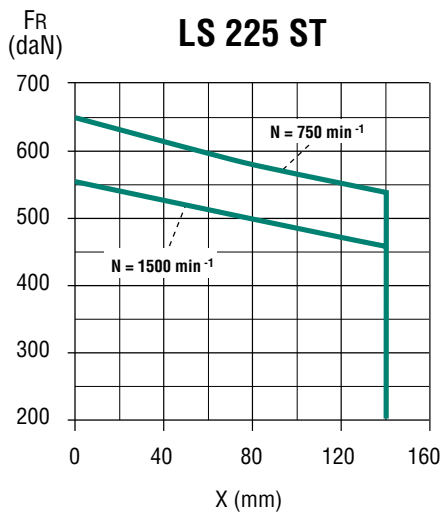
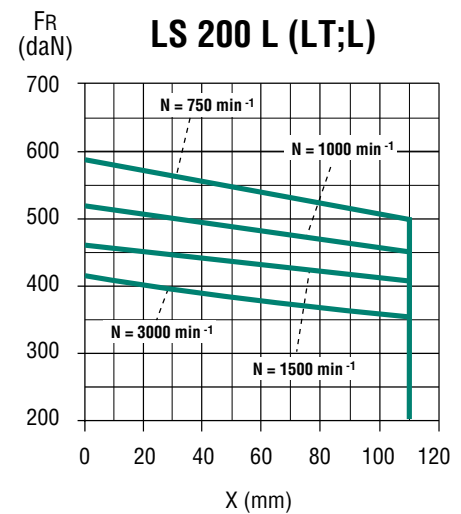
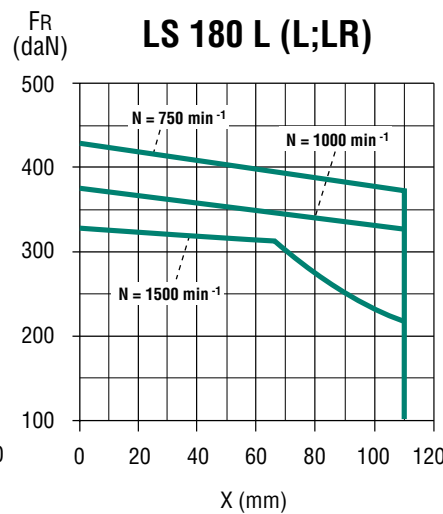
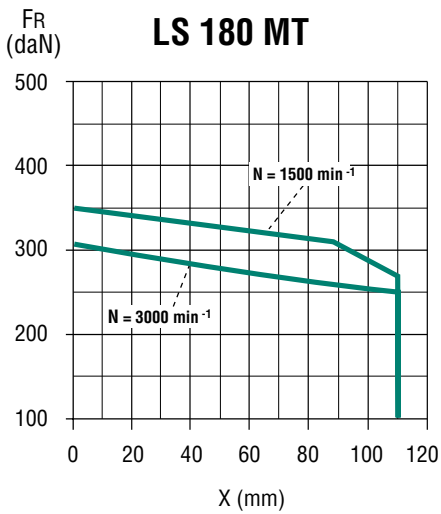
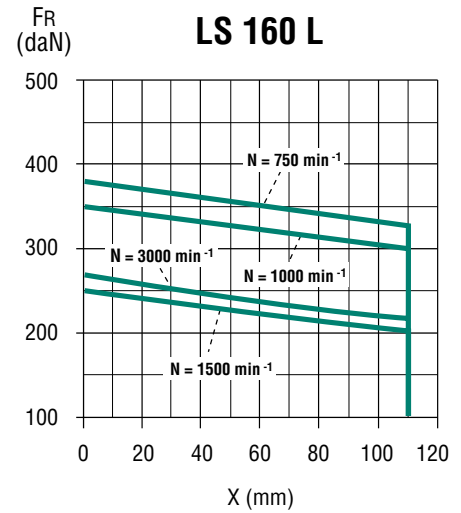
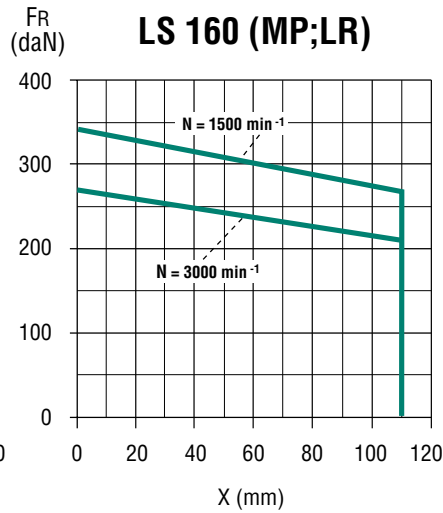
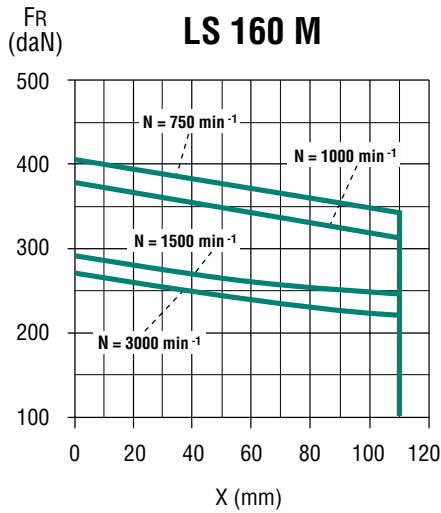

3-phase TEFV induction motors LS aluminium alloy frame Construction

C3 - Bearings and lubrication

C3.30.2 - Standard assembly

Permissible radial load on main shaft extension with a bearing life L_{10h} of 25,000 hours.

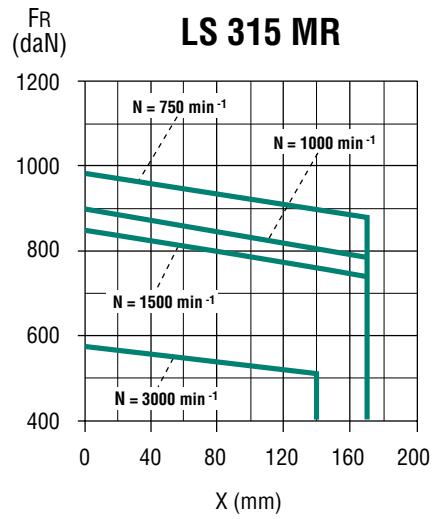
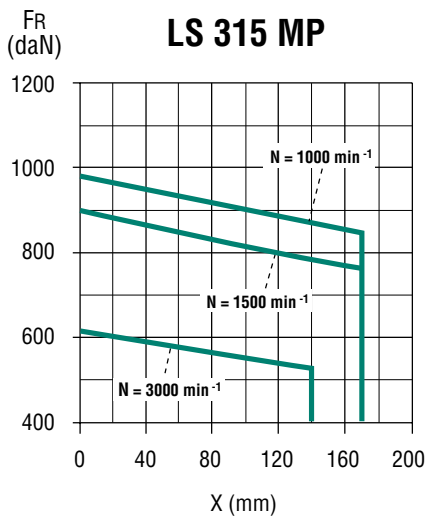
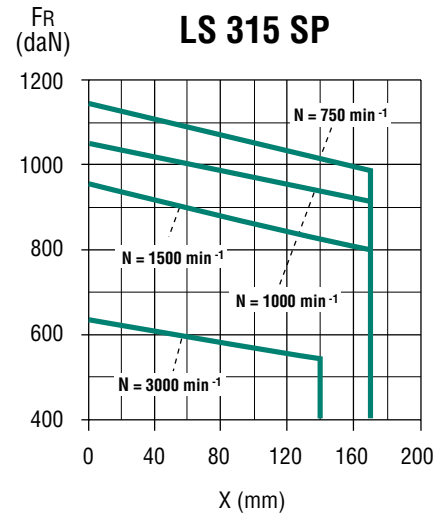
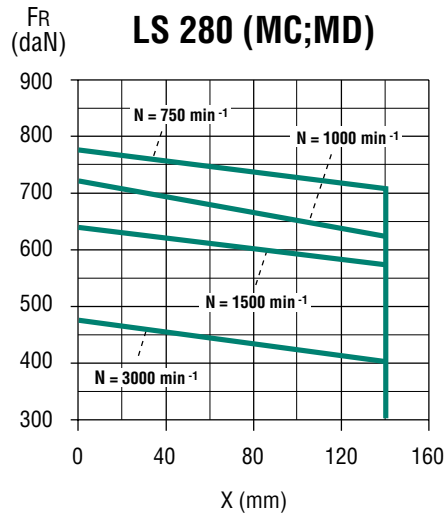
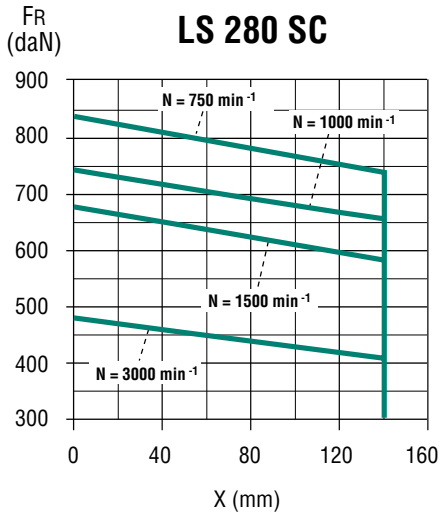

3-phase TEFV induction motors LS aluminium alloy frame Construction

C3 - Bearings and lubrication

C3.4 - TYPES AND SPECIAL FITTING ARRANGEMENTS FOR DE ROLLER BEARINGS

Motor		No. of poles	Standard mounting			
Frame size	LEROY-SOMER Designation		Non drive end bearing (N.D.E.)	Drive end bearing (D.E.)	Assembly diagram reference	
					Foot mounted motors	Flange mounted (or foot and flange) motors
160	LS 160 M/L	6 ; 8	6210 Z C3	NU 309	1	5
160	LS 160 LU	*	6210 Z C3	NU 309	1	5
180	LS 180 MT	4	6210 Z C3	NU 310	1	5
180	LS 180 LR	4	6210 Z C3	NU 310	1	5
180	LS 180 L	6 ; 8	6212 Z C3	NU 310	1	5
180	LS 180 LU	*	6212 Z C3	NU 310	1	5
200	LS 200 LT	4 ; 6	6212 Z C3	NU 312	1	5
200	LS 200 L	6 ; 8	6214 Z C3	NU 312	1	5
200	LS 200 LU	*	6312 C3	NU 312	1	5
225	LS 225 ST	4 ; 8	6214 Z C3	NU 313	1	5
225	LS 225 MR	4 ; 6 ; 8	6312 C3	NU 313	2	6
225	LS 225 MG	*	6216 C3	NU 314	3	3
250	LS 250 ME	4	6216 C3	NU 314	3	3
280	LS 280 SC	4	6216 C3	NU 316	3	3
280	LS 280 MD	4	6218 C3	NU 316	3	3
280	LS 280 SK - MK	*	6317 C3	NU 317	4	4
315	LS 315 SP - MP - MR	4 ; 6 ; 8	6317 C3	NU 320	4	4

* 2-speed motors (excluding 2-pole motors).

C3.4.1 - Bearing assembly diagrams

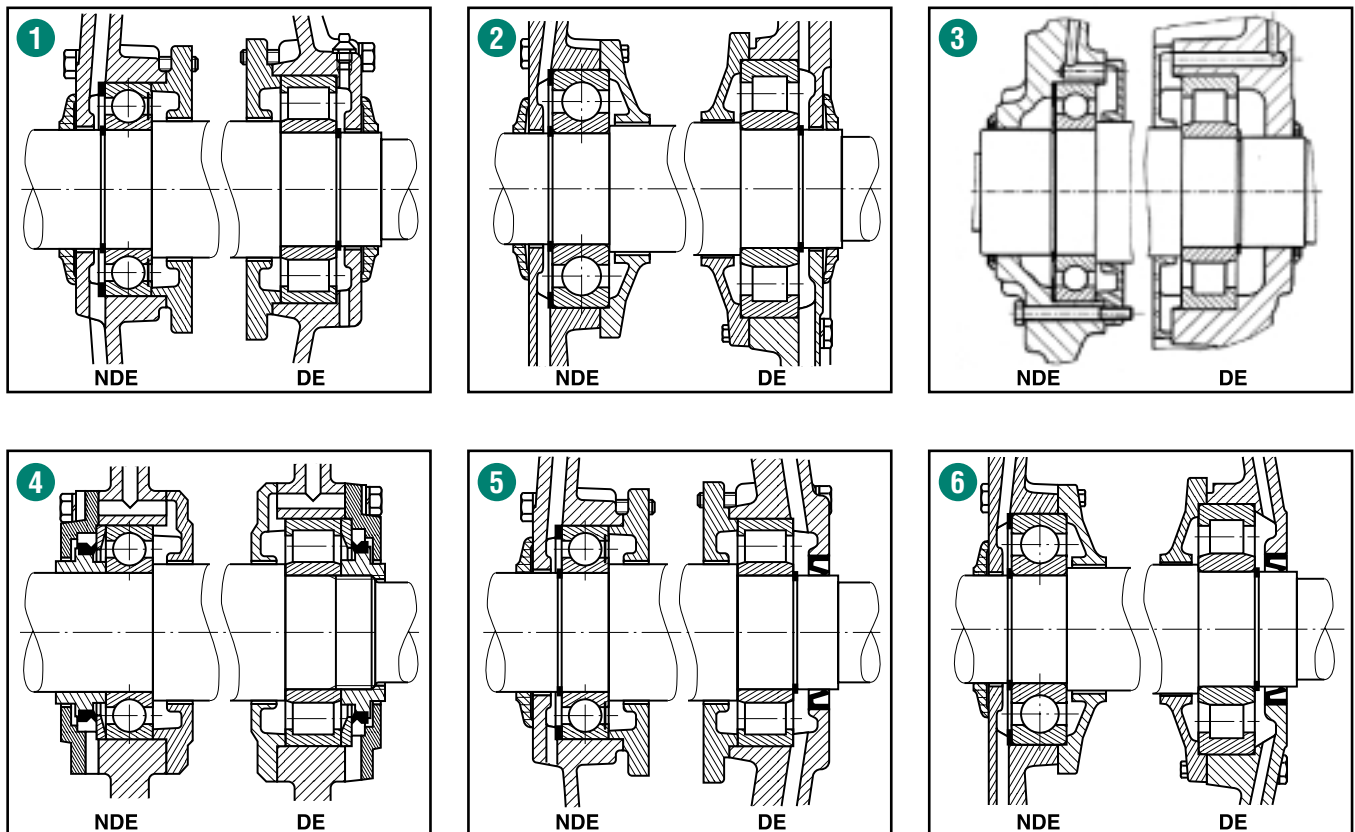

3-phase TEFV induction motors LS aluminium alloy frame Construction

C3 - Bearings and lubrication

C3.4.2 - Special fitting arrangements

Permissible radial load on main shaft extension with a bearing life L_{10h} of 25,000 hours.

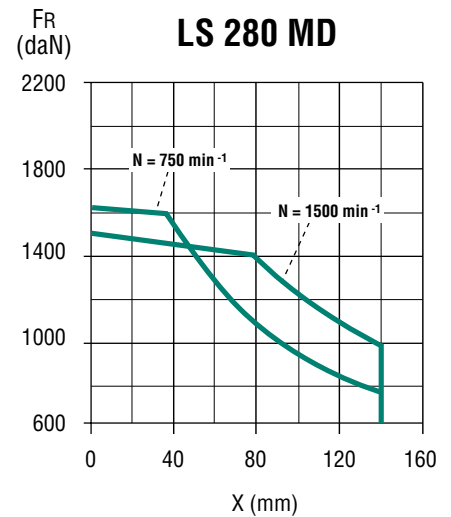
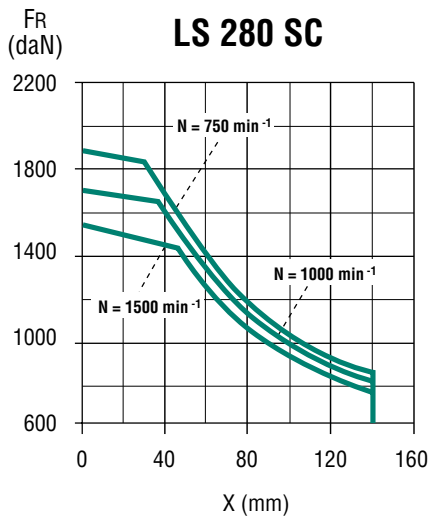
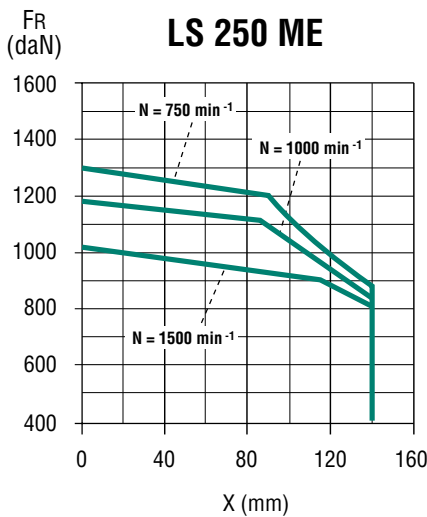
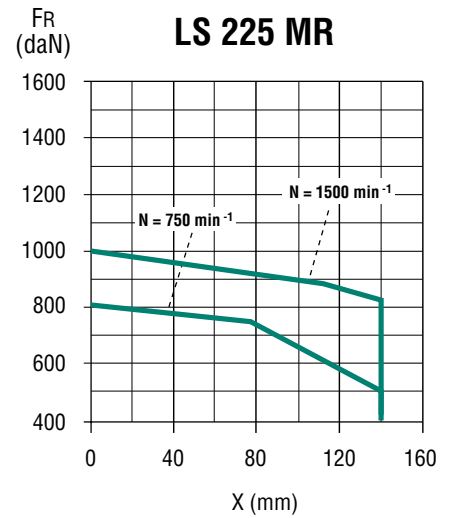
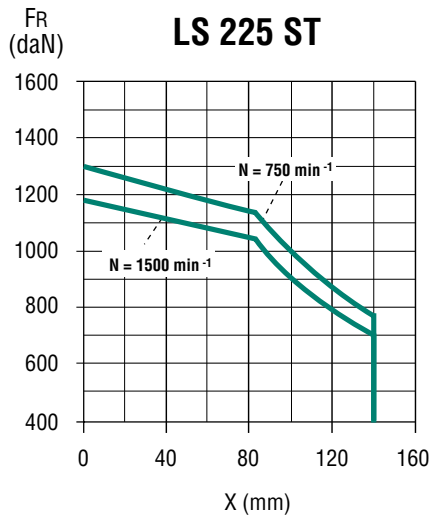
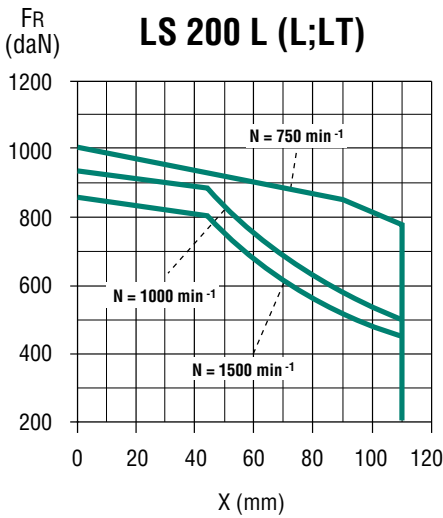
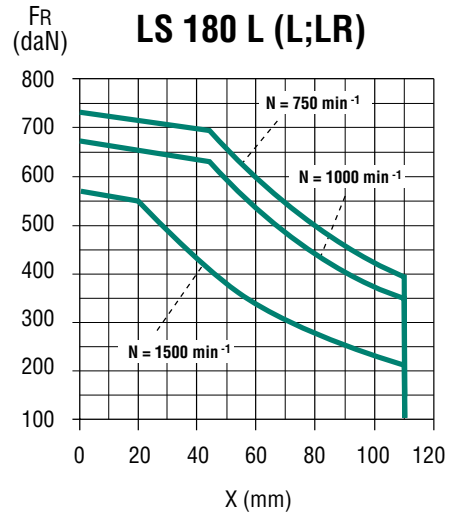
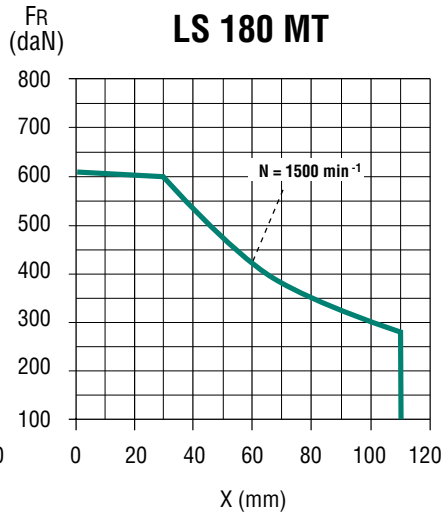
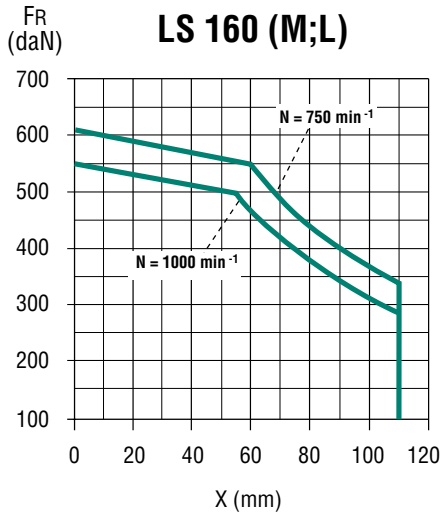

3-phase TEFV induction motors LS aluminium alloy frame Construction

C3 - Bearings and lubrication

C3.4.2 - Special fitting arrangements

Permissible radial load on main shaft extension with a bearing life L_{10h} of 25,000 hours.

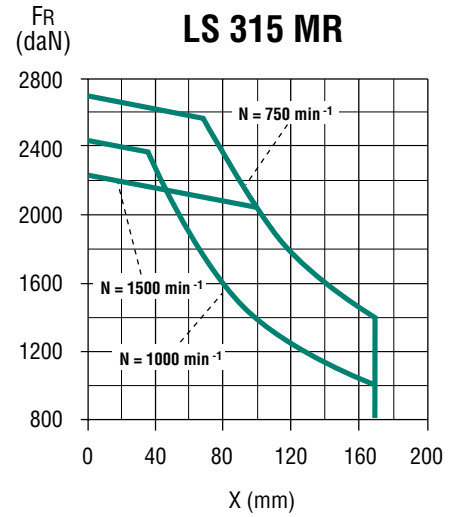
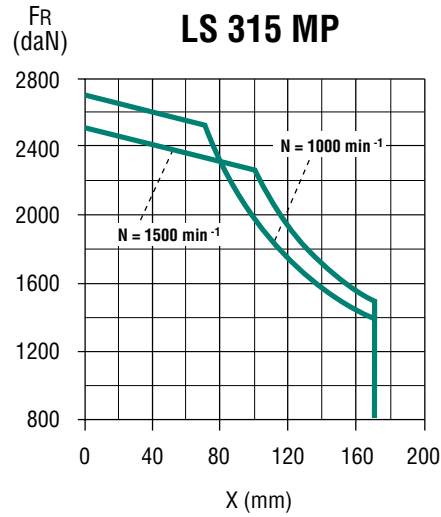
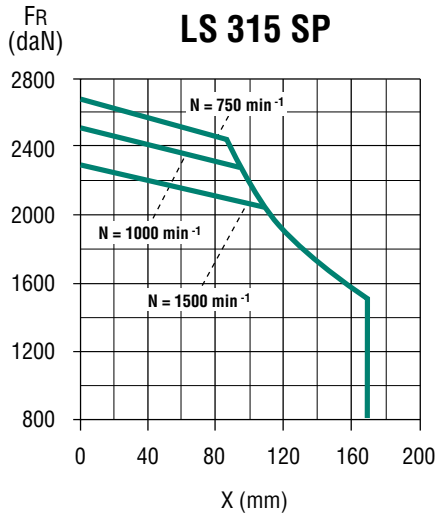

3-phase TEFV induction motors LS aluminium alloy frame Construction

C3 - Bearings and lubrication

C3.5 - BEARINGS AND BEARING LIFE

Definitions

Load ratings

- Basic static load C_0 :

This is the load for which permanent deformation at point of contact between a bearing race and the ball (or roller) with the heaviest load reaches 0.01% of the diameter of the ball (or roller).

- Basic dynamic load C :

This is the load (constant in intensity and direction) for which the nominal lifetime of the bearing will reach 1 million revolutions.

The static load rating C_0 and dynamic load rating C are obtained for each bearing by following the method in ISO 281.

Lifetime

The lifetime of a bearing is the number of revolutions (or number of operating hours at a constant speed) that the bearing can accomplish before the first signs of fatigue (spalling) begin to appear on a ring, ball or roller.

- Nominal lifetime L_{10h}

According to the ISO recommendations, the nominal lifetime is the length of time completed or exceeded by 90% of apparently identical bearings operating under the conditions specified by the manufacturer.

Note: The majority of bearings last much longer than the nominal lifetime; the average lifetime achieved or exceeded by 50% of bearings is around 5 times longer than the nominal lifetime.

Determination of nominal lifetime

Constant load and speed of rotation

The nominal lifetime of a bearing expressed in operating hours L_{10h} , the basic dynamic load C expressed in daN and the applied loads (radial load F_r and axial load F_a) are related by the following equation:

$$L_{10h} = \frac{1000000}{60 \cdot N} \cdot \left(\frac{C}{P}\right)^p$$

where N = speed of rotation (min⁻¹)

P ($P = X F_r + Y F_a$): equivalent dynamic load (F_r , F_a , P in daN)

p : an index which depends on the type of contact between the races and balls (or rollers)

$p = 3$ for ball bearings

$p = 10/3$ for roller bearings

The formulae that give Equivalent Dynamic Load (values of factors X and Y) for different types of bearing may be obtained from their respective manufacturers.

Variable load and speed of rotation

For bearings with periodically variable load and speed, the nominal lifetime is established using the equation:

$$L_{10h} = \frac{1000000}{60 \cdot N_m} \cdot \left(\frac{C}{P_m}\right)^p$$

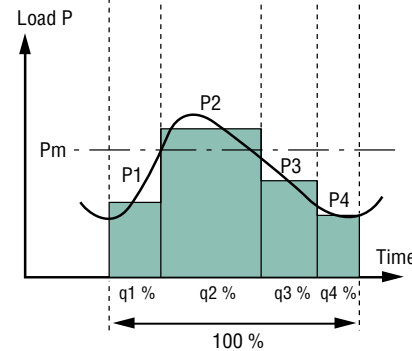
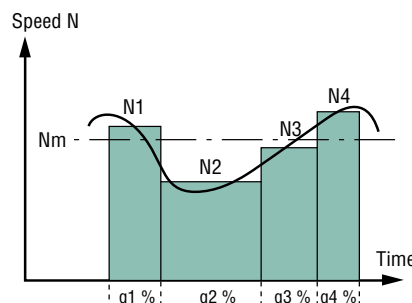

N_m : average speed of rotation

$$N_m = N_1 \cdot \frac{q_1}{100} + N_2 \cdot \frac{q_2}{100} + \dots (\text{min}^{-1})$$

P_m : average equivalent dynamic load

$$P_m = \sqrt[p]{P_1^{1/p} \cdot \left(\frac{N_1}{N_m}\right) \cdot \frac{q_1}{100} + P_2^{1/p} \cdot \left(\frac{N_2}{N_m}\right) \cdot \frac{q_2}{100} + \dots (\text{daN})}$$

with q_1, q_2, \dots etc as a %

Nominal lifetime L_{10h} is applicable to bearings made of bearing steel and normal operating conditions (lubricating film present, no contamination, correctly fitted, etc).

Situations and data differing from these conditions will lead to either a reduction or an increase in lifetime compared to the nominal lifetime.

Corrected nominal lifetime

If the ISO recommendations (DIN ISO 281) are used, improvements to bearing steel, manufacturing processes and the effects of operating conditions may be integrated in the nominal lifetime calculation.

The theoretical pre-fatigue lifetime L_{nah} is thus calculated using the formula:

$$L_{nah} = a_1 a_2 a_3 L_{10h}$$

where:

a_1 : failure probability factor

a_2 : factor for the characteristics and tempering of the steel

a_3 : factor for the operating conditions (lubricant quality, temperature, speed of rotation, etc)

Under normal operating conditions for LS motors, the corrected nominal lifetime, calculated with a failure probability factor $a_1 = 1$ (L_{10ah}), is longer than the nominal lifetime L_{10h} .

3-phase TEFV induction motors LS aluminium alloy frame Construction

C3 - Bearings and lubrication

C3.6 - LUBRICATION AND MAINTENANCE OF BEARINGS

Role of the lubricant

The principal role of the lubricant is to avoid direct contact between the metal parts in motion: balls or rollers, slip-rings, cages, etc. It also protects the bearing against wear and corrosion.

The quantity of lubricant needed by a bearing is normally quite small. There should be enough to provide good lubrication without undesirable overheating. As well as lubrication itself and the operating temperature, the amount of lubricant should be judged by considerations such as sealing and heat dissipation.

The lubricating power of a grease or an oil lessens with time owing to mechanical constraints and straightforward ageing. Used or contaminated lubricants should therefore be replaced or topped up with new lubricant at regular intervals.

Bearings can be lubricated with grease, oil or, in certain cases, with a solid lubricant.

C3.6.1 - Lubricating with grease

A lubricating grease can be defined as a product of semi-fluid consistency obtained by the dispersion of a thickening agent in a lubricating fluid and which may contain several additives to give it particular properties.

Composition of a grease
Base oil: 85 to 97%
Thickener: 3 to 15%
Additives: 0 to 12%

The base oil lubricates

The oil making up the grease is of **prime importance**. It is the oil that lubricates the moving parts by coating them with a protective film which prevents direct contact. The thickness of the lubricating film is directly linked to the viscosity of the oil, and the viscosity itself depends on temperature. The two main types used to make grease are mineral oils and synthetic oils. Mineral oils are suitable for normal applications in a range of temperatures from -30° to +150°C. Synthetic oils have the advantage of being effective in severe conditions (extreme variations of temperature, harsh chemical environments, etc).

The thickener gives the grease consistency

The more thickener a grease contains, the 'harder' it will be. Grease consistency varies with the temperature. In falling temperatures, the grease hardens progressively, and the opposite happens when temperatures rise.

The consistency of a grease can be quantified using the NLGI (National Lubricating Grease Institute) classification. There are 9 NLGI grades, from 000 for the softest greases up to 6 for the hardest. Consistency is expressed by the depth to which a cone may be driven into a grease maintained at 25 °C.

If we only consider the chemical nature of the thickener, lubricating greases fall into three major categories:

- **conventional greases with a metallic soap base** (calcium, sodium, aluminium, lithium). Lithium soaps have several advantages over other metallic soaps: a high melting point (180° to 200°), good mechanical stability and good water resistant properties.
- **greases with a complex soap base** The main advantage of this type of soap is a very high melting point (over 250°C).
- **soapless greases.** The thickener is an inorganic compound, such as clay. Their main property is the absence of a melting point, which makes them practically non-liquefying.

Additives improve some properties of greases

Additives fall into two types, depending on whether or not they are soluble in the base oil.

The most common insoluble additives - graphite, molybdenum disulphide, talc, mica, etc, improve the friction characteristics between metal surfaces. They are therefore used in applications where heavy pressure occurs.

The soluble additives are the same as those used in lubricating oils: antioxidants, anti-rust agents, etc.

C3.6.2 - Grease life

The lifetime of a lubricating grease depends on:

- the characteristics of the grease (type of soap and base oil, etc)
- service stress (type and size of bearing, speed of rotation, operating temperature, etc)
- contamination

C3.6.2.1 - Permanently greased bearings

For motors from 56 frame to 132 frame, the type and size of the bearings make for long grease life and therefore lubrication for the lifetime of the machine. The grease life L_{10h} according to speed of rotation and ambient temperature is shown on the chart opposite.

▼ Grease life L_{10h} in 000's of hours, for frames sizes < 132.

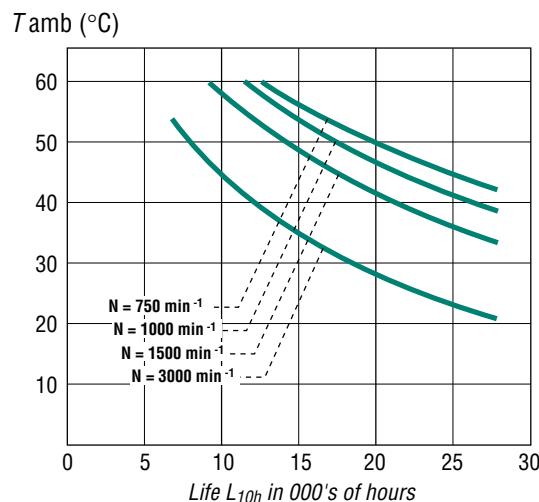

3-phase TEFV induction motors LS aluminium alloy frame Construction

C3 - Bearings and lubrication

C3.6.2.2 - Bearings without grease nipples

Motors of frame sizes 160 and 180 with permanently greased bearings and motors of frame size 200 with bearings, factory lubricated with a complex lithium soap grease that has an operating range of -20°C to +150°C, are not fitted with grease nipples.

Lubricant lifetime (L10h) under normal operating conditions is given in the table below for a machine with horizontal shaft operating at 50 Hz and 60 Hz in ambient temperatures of 25°C or less.

Speed \ Frame size	3600	3000	1800	1500
160	≥ 40,000	≥ 40,000	≥ 40,000	≥ 40,000
180	≥ 40,000	≥ 40,000	≥ 40,000	≥ 40,000
200	16000	24000	32000	≥ 40,000

Note: On request, motors of frame size 90 to 200 mm can be fitted with grease nipples, and motors of frame sizes 225 and 250 can be supplied without grease nipples.

C3.6.2.3 - Bearings with grease nipples

The chart opposite shows the regreasing intervals, depending on the type of motor, for standard bearing assemblies of frame size ≥ 160 fitted with grease nipples, operating at an ambient temperature of 25°C on a horizontal shaft machine.

The chart opposite is valid for LS motors lubricated with ESSO UNIREX N3 grease, which is used as standard.

C3.6.2.4 - Special construction and environment

For vertical shaft machines operating at an ambient 25°C, the regreasing intervals will be approximately 80% of those shown on the chart.

Motors operating at an ambient 40°C need more frequent lubrication. The intervals between greasing will be about half of those shown on the chart.

Note: the quality and quantity of grease and the regreasing interval are shown on the machine identification plate.

For special assemblies (motors fitted with DE roller bearings or other types), machines of frame size ≥ 160 have bearings with grease nipples. Instructions for bearing maintenance are given on the identification plates on these machines.

▼ Regreasing intervals according to frame size and speed of rotation (for standard bearing assemblies).

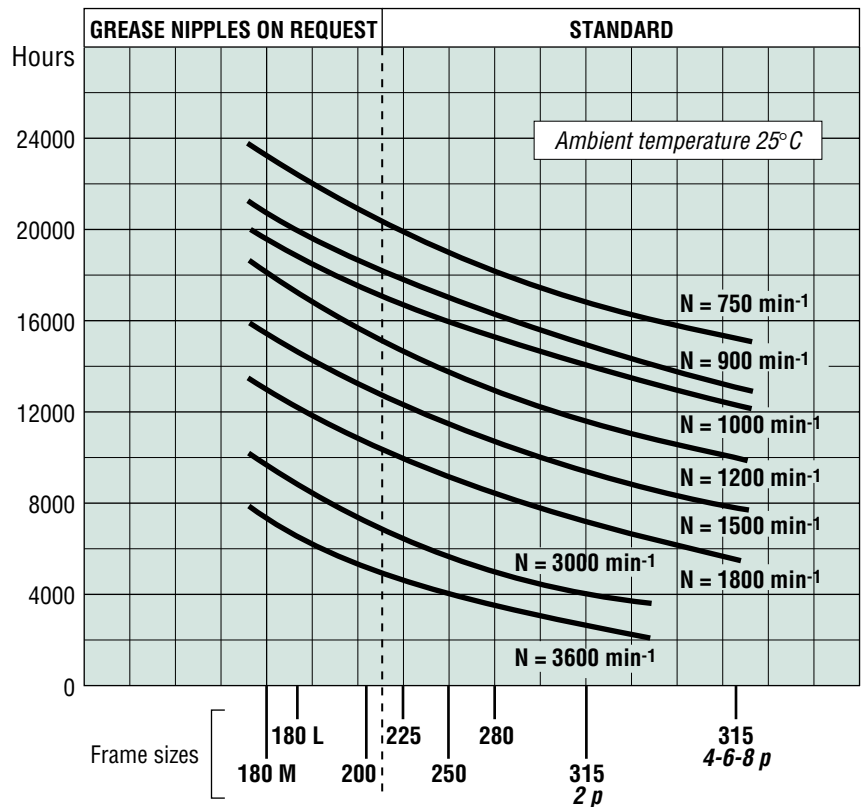

3-phase TEFV induction motors LS aluminium alloy frame Construction

C4 - Cooling

LS motors are of standard configuration IC 411

New designation for the IC (International Cooling) coded cooling method in the IEC 60034-6 standard.

The standard allows for two designations (general formula and simplified formula) as shown in the example opposite.

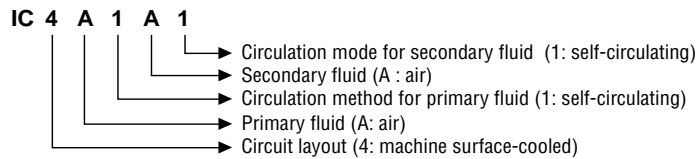

Note: the letter A may be omitted if this will not lead to confusion. This contracted formula becomes the simplified formula.
Simplified form: **IC 411**.

Circuit layout

Characteristic number	Designation	Description
0 ⁽¹⁾	Free circulation	The coolant enters and leaves the machine <i>freely</i> . It is taken from and returned to the fluid round the machine.
1 ⁽¹⁾	Machine with an intake pipe	The coolant is taken up elsewhere than from the fluid round the machine, brought into the machine through an <i>intake pipe</i> and emptied into the fluid round the machine.
2 ⁽¹⁾	Machine with an outlet pipe	The coolant is taken up from the fluid round the machine, brought away from the machine by an <i>outlet pipe</i> and does not go back into the fluid round the machine.
3 ⁽¹⁾	Machine with two pipes (intake and outlet)	The coolant is taken up elsewhere than from the fluid round the machine, brought to the machine through an <i>intake pipe</i> , then taken away from the machine through an <i>outlet pipe</i> and does not go back into the fluid round the machine.
4	Surface cooled machine using the fluid round the machine	The primary coolant circulates in a closed circuit, transferring its heat to a secondary coolant (the one surrounding the machine) through the machine casing. The casing surface is either smooth or finned to improve heat transmission.
5 ⁽²⁾	Built-in heat exchanger (using the surrounding environment)	The primary coolant circulates in a <i>closed</i> circuit, transferring its heat to a secondary coolant (the one surrounding the machine) in an integral heat exchanger inside the machine.
6 ⁽²⁾	Machine-mounted heat exchanger (using the surrounding environment)	The primary coolant circulates in a closed circuit, transferring its heat to a secondary coolant (the one surrounding the machine) in a heat exchanger that forms an independent unit, mounted on the machine.
7 ⁽²⁾	Built-in heat exchanger (not using the surrounding environment)	The primary coolant circulates in a closed circuit, transferring its heat to a secondary coolant (which is not the one round the machine) in an integral heat exchanger inside the machine.
8 ⁽²⁾	Machine-mounted heat exchanger (not using the surrounding environment)	The primary coolant circulates in a closed circuit, transferring its heat to a secondary coolant (which is not the one round the machine) in a heat exchanger that forms an independent unit, mounted on the machine.
9 ⁽²⁾⁽³⁾	Separate heat exchanger (using/not using the surrounding environment)	The primary coolant circulates in a closed circuit, transferring its heat to the secondary fluid in a heat exchanger that forms an independent unit, away from the machine.

Coolant

Characteristic letter	Type of fluid
A	Air
F	Freon
H	Hydrogen
N	Nitrogen
C	Carbon dioxide
W	Water
U	Oil
S	Any other fluid (must be identified separately)
Y	The fluid has not yet been selected (used temporarily)

Method of circulation

Characteristic number	Designation	Description
0	Free circulation	The circulation of the coolant is due only to differences in temperature. Ventilation caused by the rotor is negligible.
1	Self-circulating	The circulation of the coolant depends on the rotational speed of the main machine, and is caused by the action of the rotor alone, or a device mounted directly on it.
2, 3, 4		Not yet defined.
5 ⁽⁴⁾	Built-in, independent device	The coolant is circulated by a built-in device which is powered independently of the rotational speed of the main machine.
6 ⁽⁴⁾	Independent device mounted on the machine	The coolant is circulated by a device mounted on the machine which is powered independently of the rotational speed of the main machine.
7 ⁽⁴⁾	Entirely separate independent device or using the pressure of the coolant circulation system	The coolant is circulated by a separate electrical or mechanical device, independent and not mounted on the machine, or by the pressure in the coolant circulation system.
8 ⁽⁴⁾	Relative displacement	The circulation of the coolant is produced by the relative movement between the machine and the coolant, either by displacement of the machine in relation to the coolant, or by the flow of the surrounding coolant.
9	Any other device	The coolant is circulated using a method other than those defined above: it must be described in full.

(1) Filters or labyrinths for dust removal or noise protection can be fitted inside the casing or in the ducting. The first designation numbers 0 to 3 also apply to machines in which the coolant is taken up at the outlet of a watercooler designed to lower the temperature of the ambient air or recirculated through a watercooler so as not to increase the ambient temperature.

(2) The nature of the heat exchanger elements is not specified (smooth or finned tubes, corrugated surfaces, etc).

(3) A separate heat exchanger can be installed near to or at a distance from the machine. A secondary gas coolant may or may not be the surrounding medium.

(4) Use of such a device does not exclude the ventilating action of the rotor or the existence of an additional fan mounted directly on the rotor.

3-phase TEFV induction motors LS aluminium alloy frame Construction

C4 - Cooling

C4.1 - STANDARD CODES

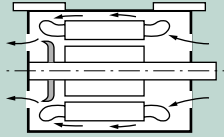
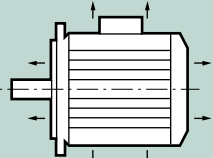
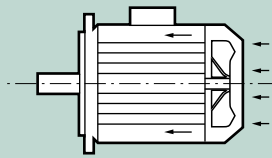
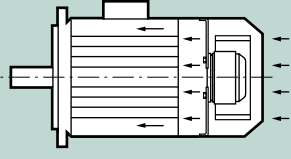
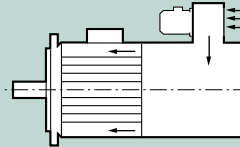
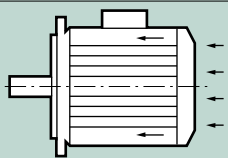
IC 01	Self-cooling open machine. Fan mounted on the shaft.	
IC 410	Enclosed machine, surface-cooled by natural convection and radiation. No external fan.	
IC 411	Enclosed machine. Smooth or finned ventilated casing. External shaft-mounted fan.	
IC 416 A*	Enclosed machine. Smooth or finned enclosed casing. External motorized axial (A) fan supplied with the machine.	
IC 416 R*	Enclosed machine. Smooth or finned enclosed casing. External motorized radial (R) fan supplied with the machine.	
IC 418	Enclosed machine. Smooth or finned casing. No external fan. Ventilation provided by air flow coming from the driven system.	

* Features not within manufacturer's standard range.

Application of cooling systems to the LEROY-SOMER range

Frame size	IC 410/IC 418	IC 411	IC 416 A	IC 416 R
56	●	○		
63	●	○		
71	●	○		
80	●	○	●	
90	●	○	●	Please consult Leroy-Somer
100	●	○	●	Please consult Leroy-Somer
112	●	○	●	Please consult Leroy-Somer
132	●	○	●	Please consult Leroy-Somer
160	●	○	●	Please consult Leroy-Somer
180	●	○	●	Please consult Leroy-Somer
200	●	○	●	Please consult Leroy-Somer
225	●	○	●	Please consult Leroy-Somer
250	●	○	●	Please consult Leroy-Somer
280	●	○	●	Please consult Leroy-Somer
315	●	○	●	Please consult Leroy-Somer

● : possible. ○ : standard construction

Other cooling systems may be fitted as options:

- complete immersion of motor in oil.
- circulation of water inside housing for frame sizes ≤ 132
- sealed motor submerged in water for frame sizes ≤ 132

3-phase TEFV induction motors LS aluminium alloy frame Construction

C4 - Cooling

C4.2 - VENTILATION

C4.2.1 - Motor ventilation

In compliance with IEC 60034-6, the motors in this catalogue are cooled using method IC 411, ie. "surface-cooled machine using the ambient air circulating round the machine".

Cooling is achieved by a fan mounted at the NDE of the motor, inside a fan cover which acts as a safety guard (control conforming to IEC 60034-5). The fan draws the air through the grille in the cover and sends it along the housing fins, giving an identical heat balance in either direction of rotation (except for 2-pole motors of frame size 315).

Note: Obstruction - even accidental - of the fan cover grille (grille clogged or placed against a wall) has an adverse effect on the motor cooling process.

Cooling of variable speed motors

Special precautions need to be taken when standard induction motors are being used with variable speed, powered by an inverter or voltage controller.

In prolonged operation at low speed, cooling efficiency is lost. It is therefore advisable to install forced ventilation that will produce a

constant flow independent of the motor speed.

In prolonged operation at high speed, the fan may make excessive noise. It is again advisable to install a forced ventilation system.

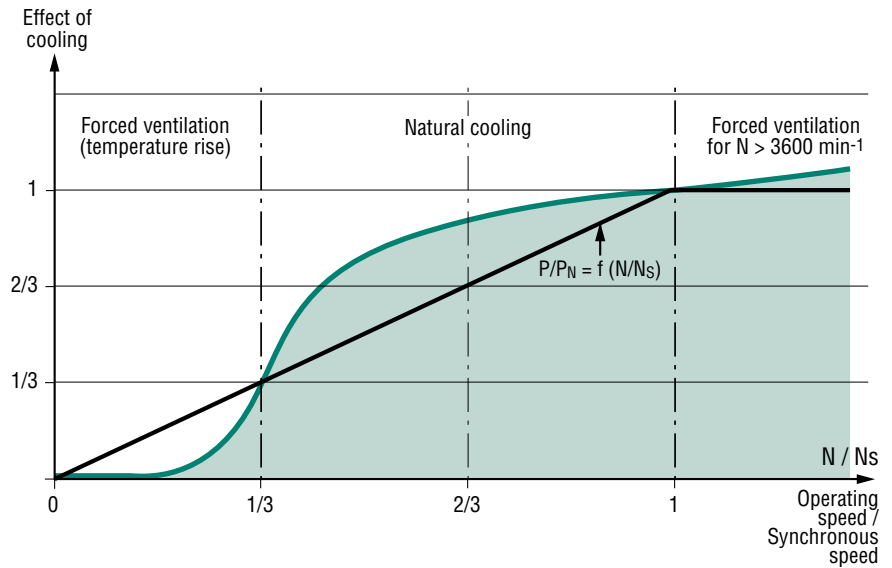

C4.2.2 - Non-ventilated applications in continuous operation

Motors can be supplied without fans. Dimensions will depend on the application.

a) IC 418 cooling system

Placed in the air flow from a fan, these motors are capable of achieving their power rating if the speed of the air between the housing fins and the overall flow rate of the air between the fins comply with the figures in the table opposite.

Frame size	2 poles		4 poles		6 poles and above	
	flow rate m ³ /h	speed m/s	flow rate m ³ /h	speed m/s	flow rate m ³ /h	speed m/s
56	37	8	16	3.5	9	2
63	50	7.5	23	4	13	2
71	82	7.5	39	4.5	24	2
80	120	7.5	60	4	40	2.5
90	200	11.5	75	5.5	60	3.5
100	300	15	130	7.5	95	5
112	460	18	200	9	140	6
132	570	21	300	10.5	220	7
160	800	21	400	11	500	9
180	900	21	600	13	550	10
200	1100	23	800	14	700	10
225	1200	24	900	15	800	13
250	1600	25	1400	17	1400	13
280	1800	25	1500	18	1500	15
315	3000	25	2000	20	2000	15

These air flows are valid for normal working conditions as described in section B2.1.

3-phase TEFV induction motors LS aluminium alloy frame Construction

C4 - Cooling

a) IC 410 cooling system

Used for general applications without cooling, these motors will provide the output powers given in the table below (if this is the case, their internal design is adapted to the power

provided, for an ambient temperature of 40°C and a temperature rise corresponding to insulation class F).

Non ventilated three-phase induction motors - 50 Hz - IC 410 (temperature rise class F)

Power kW	No. of poles 2 poles	No. of poles 4 poles	No. of poles 6 poles	No. of poles 8 poles
0.18	LS 71 L	LS 71 L	LS 80 L	LS 90 L
0.25	LS 71 L	LS 80 L	LS 80 L	LS 90 L
0.37	LS 80 L	LS 80 L	LS 90 L	LS 100 L
0.55	LS 80 L	LS 90 S	LS 90 L	LS 100 L
0.75	LS 80 L	LS 90 L	LS 100 L	LS 112 MG
0.9	LS 90 L	LS 90 L	LS 100 L	LS 112 MG
1.1	LS 90 L	LS 100 L	LS 112 MG	LS 132 SM
1.5	LS 100 L	LS 100 L	LS 112 MG	LS 132 M
1.85	LS 100 L	LS 112 MG	LS 132 M	LS 160 M
2.2	LS 112 MG	LS 112 MG	LS 132 M	LS 160 M
3	LS 132 SM	LS 132 SM	LS 160 M	LS 160 M
3.7	LS 132 SM	LS 132 M	LS 160 M	LS 160 L
4	LS 132 M	LS 132 M	LS 160 L	LS 160 L
5.5	LS 160 L	LS 160 LR	LS 160 L	LS 180 L
7.5	LS 180 MT	LS 180 MT	LS 180 L	LS 200 L
11	LS 200 L	LS 200 LT	LS 200 L	LS 225 MR
15	LS 225 MR	LS 225 ST	LS 225 MR	LS 250 MK
18.5	LS 250 MZ	LS 225 MR	LS 250 ME	LS 280 SC
22	LS 280 SC	LS 250 ME	LS 280 SC	LS 280 MD
30	LS 280 MC	LS 280 SC	LS 315 SP	LS 315 SP
37	LS 315 SP	LS 280 MD	LS 315 SP	LS 315 MP
45	LS 315 MP	LS 315 SP	LS 315 MP	-
55	LS 315 MR	LS 315 MR	LS 315 MR	-

Dimensions: see pages 105 to 109

3-phase TEFV induction motors LS aluminium alloy frame Construction

C5 - Mains connection

C5.1 - TERMINAL BOX

Placed as standard on the top of the motor near the drive end, the terminal box has IP 55 protection and is fitted with a cable gland (see table in C5.2).

The standard position of the cable gland is on the right, seen from the drive end, but, owing to the symmetrical construction of the box, it can be placed in any of the 4 directions (except position 2 on flange-mounted motors).

If required, the terminal box may be fitted in a different position (on the left or right as seen from the drive end, and at the DE or NDE of the motor housing).

▼ *Positions of the terminal box in relation to the drive end (motor in IM 1001 position)*

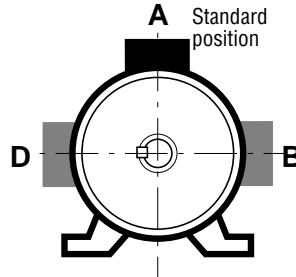

▼ *Positions of the cable gland in relation to the drive end*

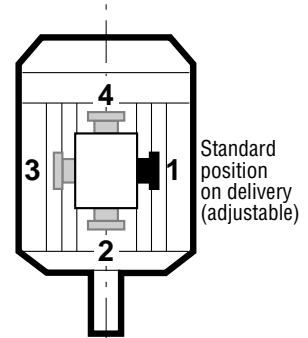

Position 2 not recommended and it is not possible on standard (FF) flange-mounted motor

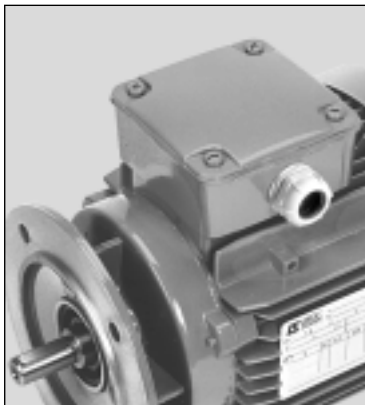

Terminal box for 71 frame

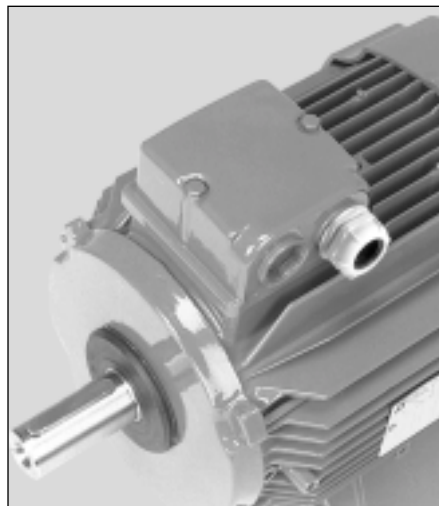

Terminal box for 80 to 112 frame

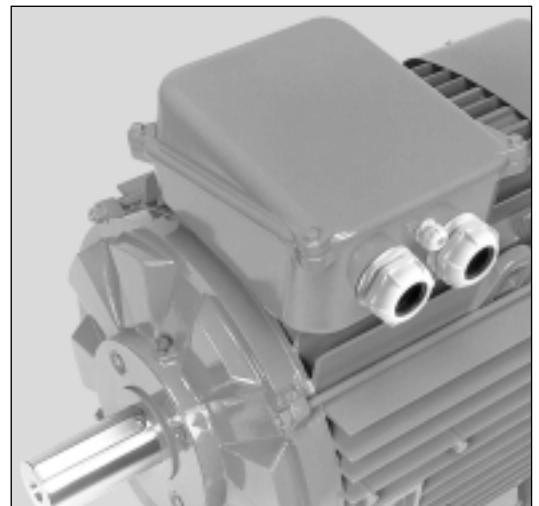

Terminal box for 200 to 315 frame

C5.1.1 - Flying leads

According to specification, motors can be supplied with flying leads or multicore cables. Please state cable characteristics (type and supplier, cross-section, length, number of conductors), connection method (on stator coil end turns, or on a separate panel), and the cable gland position required.

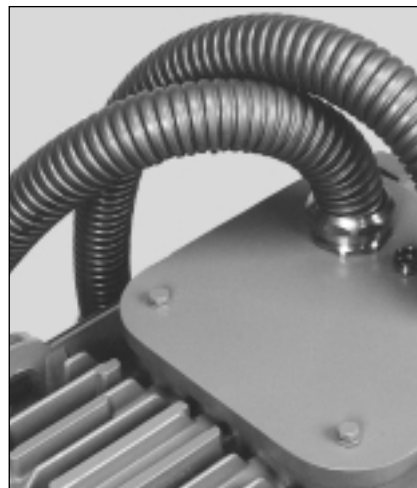

3-phase TEFV induction motors LS aluminium alloy frame Construction

C5 - Mains connection

C5.2 - TABLE OF TERMINAL BOXES AND CABLE GLANDS FOR RATED SUPPLY VOLTAGE OF 400V (according to EN 50262)

Frame size	Terminal box material	Single-speed motor		Two-speed motor		Cable gland for accessories: PTO/PTF/etc		
		D.O.L. starting	YΔ starting	2 windings	1 winding			
56	Plastic	ISO 16	-	2 x ISO 16	ISO 16	ISO 16		
63	Plastic	ISO 16	-	2 x ISO 16	ISO 16	ISO 16		
71	Plastic	ISO 16	-	2 x ISO 16	ISO 16	ISO 16		
80	Plastic	ISO 20	-	2 x ISO 20	ISO 20	ISO 16		
90	Plastic	ISO 20	-	2 x ISO 20	ISO 20	ISO 16		
100	Plastic	ISO 20*	ISO 20*	2 x ISO 20*	ISO 20*	ISO 16		
112 / 132 S	Plastic	ISO 20*	ISO 20*	2 x ISO 20*	ISO 20*	ISO 16		
132 M	Aluminium alloy	ISO 25	ISO 25	2 x ISO 25	ISO 25*	ISO 16		
160**	Aluminium alloy	2 x ISO 25	2 x ISO 25	2 x ISO 25	2 x ISO 25	ISO 16		
180**	Aluminium alloy	2 - 4p 6 - 8p	2 x ISO 32 2 x ISO 25	2 x ISO 25	2 x ISO 32	2 x ISO 32	ISO 16	
200**	Aluminium alloy	2 x ISO 32	6 - 8p 2 - 4 - 6p	2 x ISO 32 2 x ISO 25	2 x ISO 40	2 x ISO 40	ISO 16	
225**	Aluminium alloy	2 - 4p 6 - 8p	2 x ISO 40 2 x ISO 32	2 x ISO 32	2 x ISO 40	2 x ISO 40	ISO 16	
250**	Aluminium alloy	2 - 4 - 6p 8p	2 x ISO 40 2 x ISO 32	2 x ISO 32	2 x ISO 50	2 x ISO 50	ISO 16	
280**	Aluminium alloy	2 - 4p 6 - 8p	2 x ISO 50 2 x ISO 40	2 - 4p 6 - 8p	2 x ISO 40 2 x ISO 32	2 x ISO 50	2 x ISO 50	ISO 16
315 SP/MP**	Aluminium alloy	2 - 4p 6 - 8p	2 x ISO 63 2 x ISO 50	2 - 4p 6 - 8p	2 x ISO 50 2 x ISO 40	2 x ISO 63	2 x ISO 63	ISO 16
315 MR**	Aluminium alloy	2 - 4p 6p	2 x ISO 63 2 x ISO 63	2 - 4p 6p	2 x ISO 63 2 x ISO 50	-	-	ISO 16

* As an option, ISO 20 and ISO 25 cable glands may be replaced by ISO 25 and ISO 32 respectively (to comply with standard DIN 42925).

** From 160 to 315 : the number and type of cable glands are provided for information only depending on the application.

Tightening capacity of cable glands

Type of cable gland	Tightening capacity	
	Min. cable Ø (mm)	Max. cable Ø (mm)
ISO 16	6	10
ISO 20	10	15
ISO 25	13	19
ISO 32	17	25
ISO 40	24	32
ISO 50	26	38
ISO 63	31	44

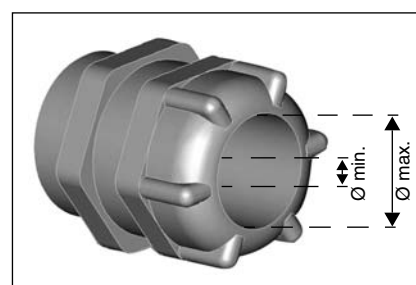

Standard cable gland material = polyamide (brass on request).
On request, the terminal boxes can be supplied with drill holes, without cable glands.

3-phase TEFV induction motors LS aluminium alloy frame Construction

C5 - Mains connection

C5.3 - TERMINAL BLOCKS - DIRECTION OF ROTATION

Standard motors are fitted with a block of six terminals complying with standard NFC 51 120, with the terminal markings complying with IEC 60034-8 (or NFEN 60034-8).

When the motor is running in U1, V1, W1 or 1U, 1V, 1W from a direct mains supply L1, L2, L3, it turns clockwise when viewed from the drive shaft end.

If any two of the phases are changed over, the motor will run in an anti-clockwise direction (make sure that the motor has been designed to run in both directions).

If the motor is fitted with accessories (thermal protection or space heater), these must be connected on screw dominos with labelled wires.

Motor type	Single-speed three-phase motor			
	D.O.L. starting		Y / Δ starting	
	Number of poles	Terminals	Number of poles	Terminals
LS 56 to 71	2 - 4 - 6 - 8	M4		
LS 80 to 132 S	2 - 4 - 6 - 8	M5	2 - 4 - 6 - 8	M5
LS 132 M to 160	2 - 4 - 6 - 8	M6	2 - 4 - 6 - 8	M6
LS 180	2 - 4 6 - 8	M8 M6	2 - 4 - 6 - 8	M6
LS 200	2 - 4 - 6 - 8	M8	6 - 8 2 - 4 - 6	M8 M6
LS 225	2 - 4 6 - 8	M10 M8	2 - 4 - 6 - 8	M8
LS 250	2 - 4 - 6 8	M10 M8	2 - 4 - 6 - 8	M10 M8
LS 280	2 - 4 6 - 8	M12 M10	2 - 4 6 - 8	M10 M8
LS 315	2 - 4 6 - 8	M16 M12	2 - 4 6 - 8	M12 M10

Tightening torque for the nuts on the terminal blocks.▶

Terminal	M4	M5	M6	M8	M10	M12	M16
Torque N.m	2	3.2	5	10	20	35	65

C5.4 - WIRING DIAGRAMS

All standard motors are supplied with a wiring diagram in the terminal box.

The diagrams normally used are shown opposite.

On the following pages are outline diagrams with internal and external connections.

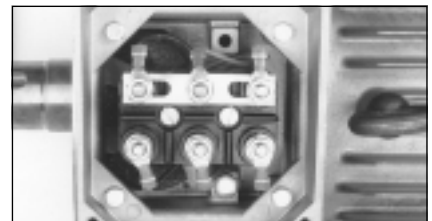
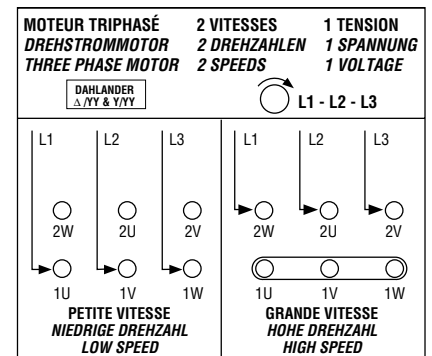
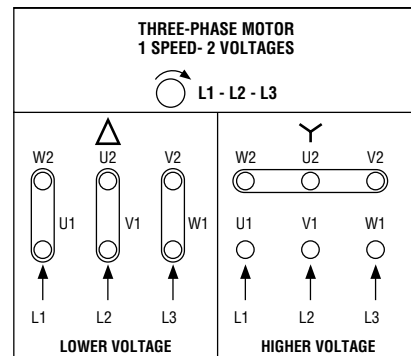
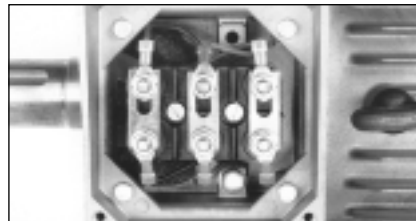

C5.5 - EARTH TERMINAL*

This is situated inside the terminal box. It is a threaded stud with a hexagonal nut (and a terminal washer for frame sizes ≤ 132) or a TORX T25 recessed head screw (for motors LS 56, 63 and 71), and will take cables with cross-sections at least as large as the cross-section of the phase conductors.

It is indicated by the sign: \perp in the terminal box moulding.

On request, a second earth terminal can be fitted on one of the feet or on one of the cooling fins.



*

3-phase TEFV induction motors LS aluminium alloy frame Construction

C6 - Motor connections

Single-speed motors

Voltages and connection	Internal connection diagrams	Outline diagrams	External connection diagrams	
			D.O.L. starting	Y / Δ starting
Single voltage motors (3 TERMINALS)				
- Voltage: U - Connection: Y internal e.g. 400 V / Y				
- Voltage: U - Connection: Δ internal e.g. 400 V / Δ				
Dual-voltage motors with Y, Δ connections (6 TERMINALS)				
- Voltage: U - Connection Δ (at lower marked voltage) e.g. 230 V / Δ				
- Voltage: $U\sqrt{3}$ - Connection Y (at higher marked voltage) e.g. 400 V / Y				
Dual-voltage motors with series-parallel connections (9 TERMINALS)				
- Voltage: U - Connection Y Y (at lower marked voltage) e.g. 230 V / Y Y				
- Voltage: 2 U - Connection Y (series-star) (at higher marked voltage) e.g. 460 V / Y				

3-phase TEFV induction motors LS aluminium alloy frame Construction

C6 - Motor connections

Two-speed motors





Voltages and connection	Internal connection diagrams	Outline diagrams	External connection diagrams	
			Manually operated	Switch operated
Single voltage motors (6 TERMINALS)				
Dahlander "constant torque" or "normal use" 6 terminals (Δ internal) Δ - Y Y		Low speed (LSP) High speed (HSP) 	 	LSP (HSP for 2 contacts)
Dahlander or PAM centrifugal machines 6 terminals (Y internal) Y - Y Y		Low speed (LSP) High speed (HSP) 	 	LSP (HSP for 2 contacts)
Two separate windings 2 x 3 terminals (Y internal)		Low speed (LSP) High speed (HSP) 	 	LSP (HSP for 2 contacts)

Note: the standardized markings appear on the cables coming from the stator windings.

3-phase TEFV induction motors LS aluminium alloy frame Construction

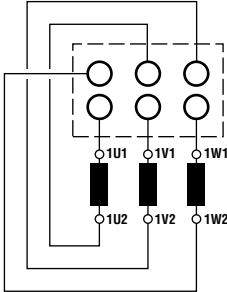
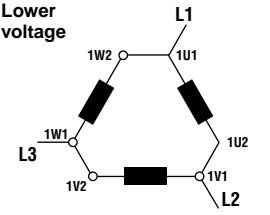
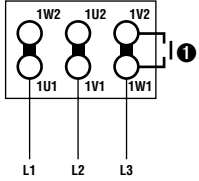
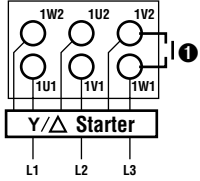
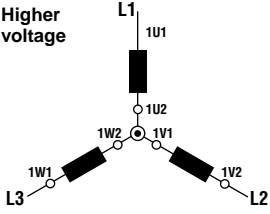
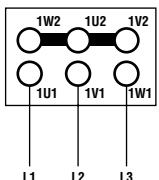
C6 - Motor connections

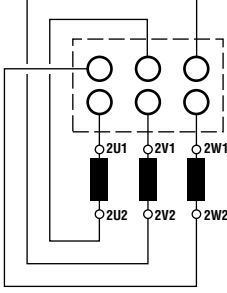
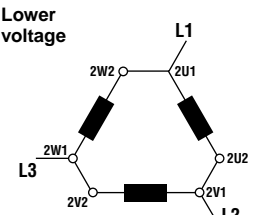
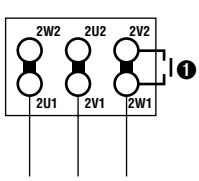
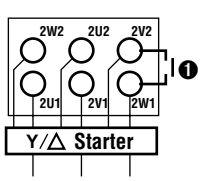
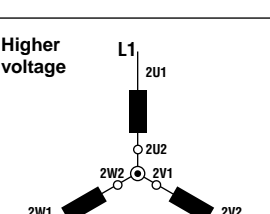
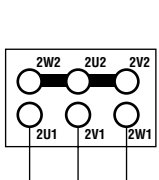
Two-speed motors

Voltages and connection	Internal connection diagrams	Outline diagrams	External connection diagrams	
			D.O.L. starting	Y / Δ starting
Dual-voltage motors with Y, Δ connections (12 TERMINALS)				
- Voltage: U - Connection Δ (at lower marked voltage) e.g. 230 V / Δ		Lower voltage 		
		Higher voltage 		
- Voltage: U - Connection Δ (at lower marked voltage) e.g. 230 V / Δ		Lower voltage 		
		Higher voltage 		

It is advisable to open the unused circuit (for the speed not in use) to avoid induced currents.

ⓘ : safety switch open when machine runs at the second speed.

3-phase TEFV induction motors LS aluminium alloy frame Operation

D1 - Duty cycle - Definitions

Typical duty cycles (according to IEC 60034-1)

The typical duty cycles are described below:

1 - Continuous duty - Type S1

Operation at constant load of sufficient duration for thermal equilibrium to be reached (see figure 1).

2 - Short-time duty - Type S2

Operation at constant load during a given time, less than that required for thermal equilibrium to be reached, followed by a rest and de-energized period of sufficient duration to re-establish machine temperatures within 2 K of the coolant (see figure 2).

3 - Intermittent periodic duty - Type S3

A sequence of identical duty cycles, each consisting of a period of operation at constant load and a rest and de-energized period (see figure 3). Here, the cycle is such that the starting current does not significantly affect the temperature rise (see figure 3).

4 - Intermittent periodic duty with starting - Type S4

A sequence of identical duty cycles, each consisting of a significant starting period, a period of operation at constant load and a rest and de-energized period (see figure 4).

5 - Intermittent periodic duty with electrical braking - Type S5

A sequence of periodic duty cycles, each consisting of a starting period, a period of operation at constant load, a period of rapid electrical braking and a rest and de-energized period (see figure 5).

6 - Periodic continuous duty with intermittent load - Type S6

A sequence of identical duty cycles, each consisting of a period of operation at constant load and a period of operation at no load. There is no rest and de-energized period (see figure 6).

7 - Periodic continuous duty with electrical braking - Type S7

A sequence of identical duty cycles, each consisting of a starting period, a period of operation at constant load and a period of electrical braking. There is no rest and de-energized period (see figure 7).

8 - Periodic continuous duty with related changes of load and speed - Type S8

A sequence of identical duty cycles, each consisting of a period of operation at constant load corresponding to a predetermined rotation speed, followed by one or more periods of operation at other constant loads

corresponding to different rotation speeds (in induction motors, this can be done by changing the number of poles). There is no rest and de-energized period (see figure 8).

9 - Duty with non-periodic variations in load and speed - Type S9

This is a duty in which the load and speed generally vary non-periodically within the permissible operating range. This duty frequently includes applied overloads which may be much higher than the full load or loads (see figure 9).

Note - For this type of duty, the appropriate full load values must be used as the basis for calculating overload.

10 - Operation at discrete constant loads - Type S10

This duty consists of a maximum of 4 discrete load values (or equivalent loads), each value being applied for sufficient time for the machine to reach thermal equilibrium. The minimum load during a load cycle may be zero (no-load operation or rest and de-energized period) (see figure 10).

Note: In section D4.6, there is a method for specifying machines in intermittent duty.

▼ Fig. 1. - Continuous duty, Type S1.

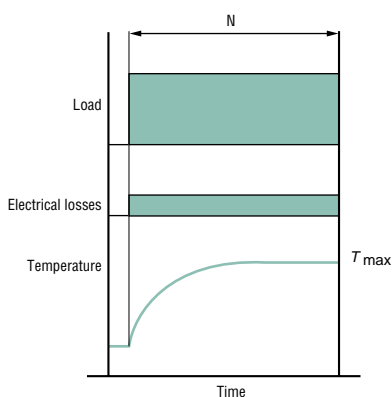

N = operation at constant load

T_{max} = maximum temperature attained

▼ Fig. 2. - Short-time duty, Type S2.

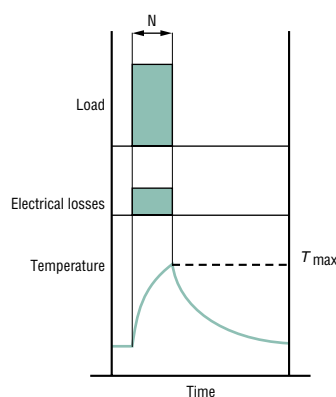

N = operation at constant load

T_{max} = maximum temperature attained

▼ Fig. 3. - Intermittent periodic duty, Type S3.

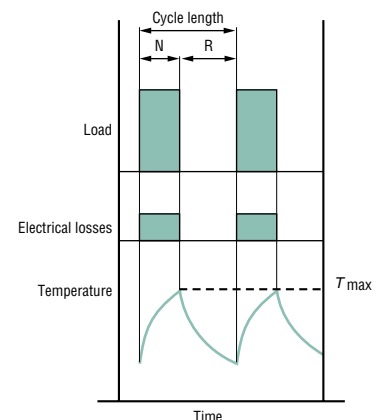

N = operation at constant load

R = rest

T_{max} = maximum temperature attained

$$\text{Operating factor (\%)} = \frac{N}{N + R} \cdot 100$$

3-phase TEFV induction motors LS aluminium alloy frame Operation

D1 - Duty cycle - Definitions

▼ Fig. 4. - Intermittent periodic duty with starting, Type S4.

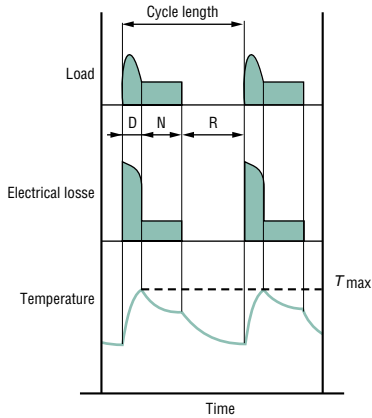

D = starting
N = operation at constant load
R = rest
 T_{max} = maximum temperature attained during cycle

$$\text{Operating factor (\%)} = \frac{D + N}{N + R + D} \cdot 100$$

▼ Fig. 5. - Intermittent periodic duty with electrical braking, Type S5.

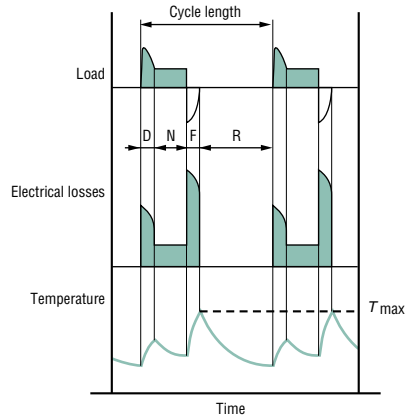

D = starting
N = operation at constant load
F = electrical braking
R = rest
 T_{max} = maximum temperature attained during cycle

$$\text{Operating factor (\%)} = \frac{D + N + F}{D + N + F + R} \cdot 100$$

▼ Fig. 6. - Periodic continuous duty with intermittent load, Type S6.

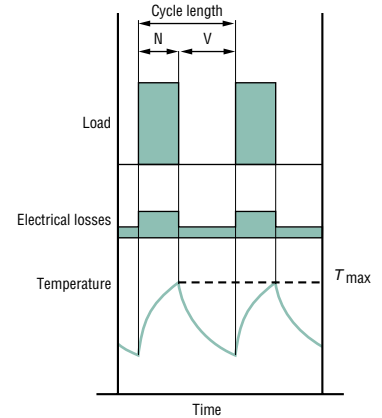

N = operation at constant load
V = no-load operation
 T_{max} = maximum temperature attained during cycle

$$\text{Operating factor (\%)} = \frac{N}{N + V} \cdot 100$$

▼ Fig. 7. - Periodic continuous duty with electrical braking, Type S7.

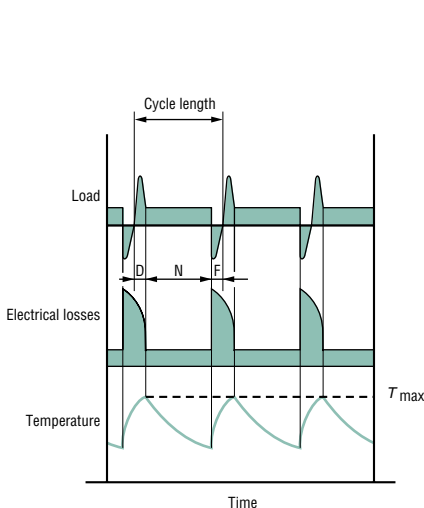

D = starting
N = operation at constant load
F = electrical braking
 T_{max} = maximum temperature attained during cycle

$$\text{Operating factor} = 1$$

▼ Fig. 8. - Periodic continuous duty with related changes of load and speed, Type S8.

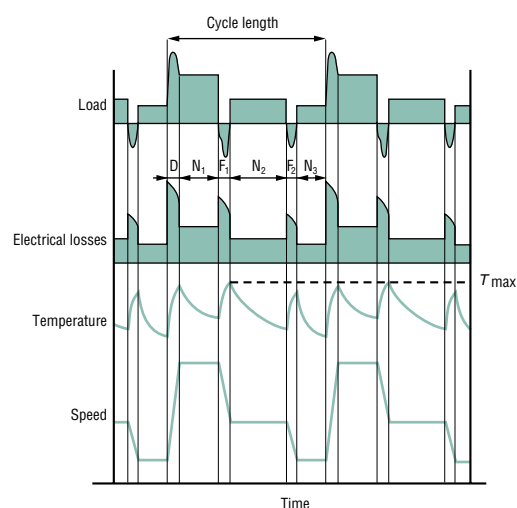

$F_1 F_2$ = electrical braking
D = starting
 $N_1 N_2 N_3$ = operation at constant loads.
 T_{max} = maximum temperature attained during cycle

$$\text{Operating factor} = \frac{D + N_1}{D + N_1 + F_1 + N_2 + F_2 + N_3} \cdot 100 \%$$

$$\frac{F_1 + N_2}{D + N_1 + F_1 + N_2 + F_2 + N_3} \cdot 100 \%$$

$$\frac{F_2 + N_3}{D + N_1 + F_1 + N_2 + F_2 + N_3} \cdot 100 \%$$

3-phase TEFV induction motors LS aluminium alloy frame Operation

D1 - Duty cycle - Definitions

▼ Fig. 9. - Duty with non-periodic variations in load and speed, Type S9.

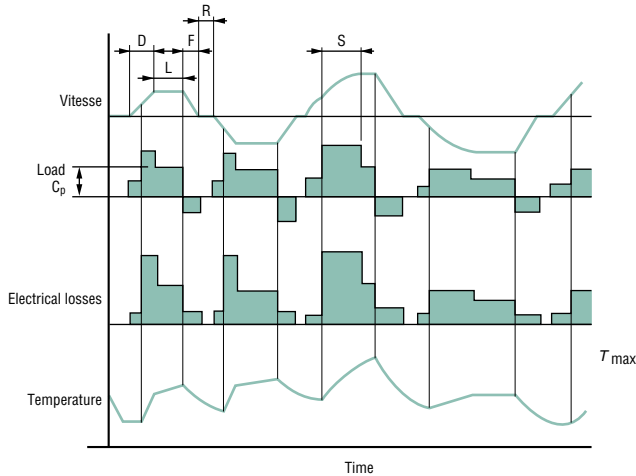

- D = starting
- L = operation at variable loads
- F = electrical braking
- R = rest
- S = operation at overload
- C_p = full load
- T_{max} = maximum temperature attained.

▼ Fig. 10. - Duty at discrete constant loads, Type S10.

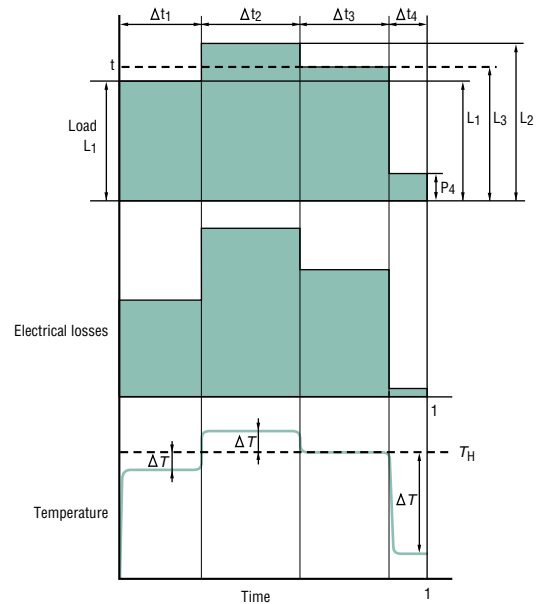

- L = load
- N = power rating for duty type S1
- $p = p / \frac{1}{N} =$ reduced load
- t = time
- T_p = total cycle time
- t_i = discrete period within a cycle
- $\Delta t_i = t_i / T_p =$ relative duration of period within a cycle
- P_u = electrical losses
- H_N = temperature at rated power for duty type S1
- ΔH_i = increase or decrease in temperature rise at the i th period of a cycle

Power is determined according to duty cycle. See section D4.6.

3-phase TEFV induction motors LS aluminium alloy frame Operation

D2 - Supply voltage

D2.1 - REGULATIONS AND STANDARDS

The statement by the electricity consultative committee dated 25th June 1982, and the 6th edition (1983) of publication No. 38 of the International Electrotechnical Committee (IEC) have laid down time scales for the harmonisation of standard voltages in Europe.

Since 1998, voltages at the point of delivery have to be maintained between the following extreme values:

- **Single-phase current: 207 to 244 V**
- **Three-phase current: 358 to 423 V**

The IEC 60038 standard gives the European reference voltage as 230 / 400 V three-phase and 230 V single-phase, with a tolerance of +6% to -10% until 2003 and $\pm 10\%$ from then on.

The tolerances usually permitted for power supply sources are indicated below:

- Maximum line drop between customer delivery point and customer usage point: 4%.
- Variation in frequency around nominal frequency:
 - continuous state : $\pm 1\%$
 - transient state : $\pm 2\%$
- Three-phase mains phase-balance error:
 - zero-sequence component and/or negative phase sequence component compared to positive phase sequence component: $< 2\%$
- Harmonics:
 - relative harmonic content: $< 10\%$
 - individual harmonic voltages: to be established
- Surges and transient power cuts: to be established

The motors in this catalogue are designed for use on the European power supply of 230 / 400 V $\pm 10\%$ - 50 Hz.

This means that the same motor can operate on the following existing supplies:

- 220 / 380 V $\pm 5\%$
- 230 / 400 V $\pm 5\%$ and $\pm 10\%$
- 240 / 415 V $\pm 5\%$

and is therefore suitable for a large number of countries worldwide where for example it is possible to extend them to some 60 Hz supplies:

- 265 / 460 V $\pm 10\%$

From 2008, 380 and 415 V - 50 Hz voltage supplies must be eliminated.

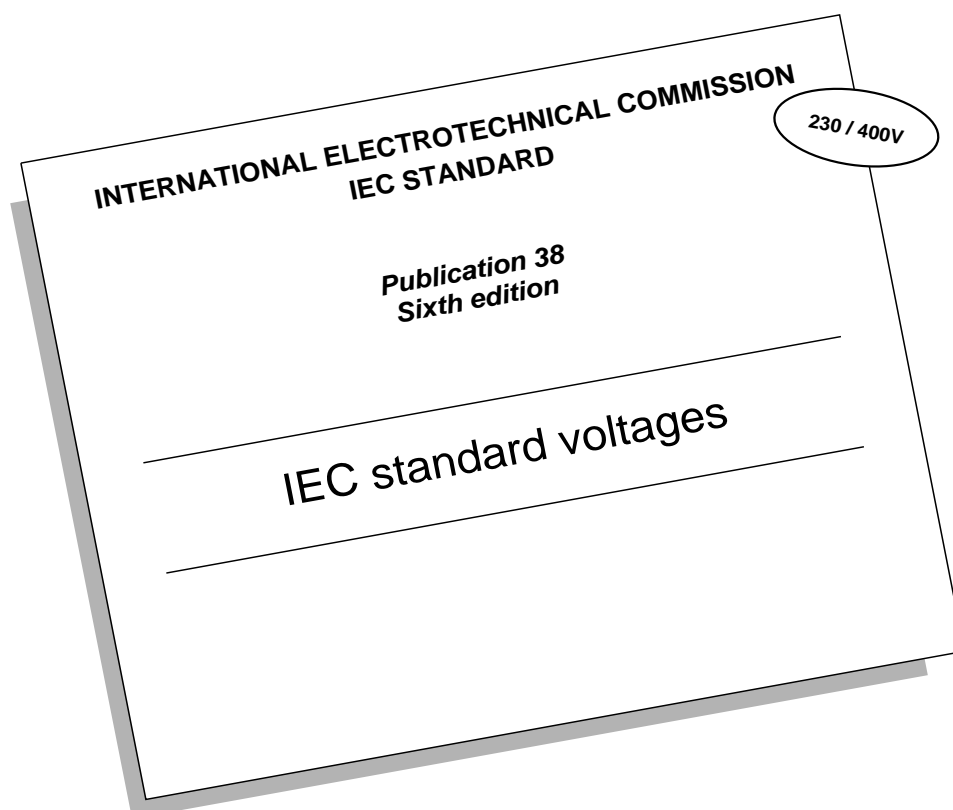

3-phase TEFV induction motors LS aluminium alloy frame Operation

D2 - Supply voltage

230 / 400 V

SECTION TWO - TABLES OF STANDARD VOLTAGES
Table 1 – A.C. systems having a nominal voltage between 100V and 1000V inclusive and related equipment

In the following table, the three-phase, four-wire systems and single-phase three-wire systems include single-phase circuits (extensions, services, etc.) connected to these systems.
The lower values in the first and second columns are voltages to neutral and the higher values are voltages between phases. When one value only is indicated, it refers to three-wire systems and specifies the voltage between phases. The lower value in the third column is the voltage to neutral and the higher value is the voltage between lines.
The voltages in excess of 230/400 V are intended exclusively for heavy industrial applications and large commercial premises.

Three-phase 3- or 4-wire systems		Single-phase 3-wire systems	
Nominal voltage (V)		Tension nominale (V)	
50 Hz	60 Hz	60 Hz	
—	120/208	120/240	
—	240	—	
—	277/480	—	
230/400 ¹⁾	480	—	
400/690 ¹⁾	347/600	—	
—	600	—	
1 000	—	—	

¹⁾ The nominal voltage of existing 220/380 V and 240/415 V systems should evolve towards the recommended value of 230/400 V. The transition period should be as short as possible and should not exceed the year 2003. During this period, as a first step, the electricity supply authorities of countries having 220/380 V systems should bring the voltage within the range 230/400 V +6%, -10% and those of countries having 240/415 V systems should bring the voltage within the range 230/400V +10%, -6%. At the end of this transition period the tolerance of 230/400 V ±10% should have been achieved ; reduction of this range should be envisaged thereafter. All the above considerations apply also to the present 370/600 V value with respect to the recommended value 400/690 V.
Under normal system conditions it is recommended that the voltage at the point of delivery should not differ from the nominal voltage by more than ± 10 %.

D2.2 - EFFECTS ON MOTOR PERFORMANCE

D2.2.1 - Voltage range

The characteristics of motors will of course vary with a corresponding variation in voltage of ±10% around the rated value.

An approximation of these variations is given in the table opposite (precise values for each motor can be supplied on request).

	Voltage variation as a %				
	UN-10%	UN-5%	UN	UN+5%	UN+10%
Torque curve	0.81	0.90	1	1.10	1.21
Slip	1.23	1.11	1	0.91	0.83
Rated current	1.10	1.05	1	0.98	0.98
Rated efficiency	0.97	0.98	1	1.00	0.98
Rated power factor (Cos φ)	1.03	1.02	1	0.97	0.94
Starting current	0.90	0.95	1	1.05	1.10
Nominal temperature rise	1.18	1.05*	1	1*	1.10
P (Watt) no-load	0.85	0.92	1	1.12	1.25
Q (reactive V A) no-load	0.81	0.9	1	1.1	1.21

* According to standard IEC 60034-1, the additional temperature rise must not exceed 10 K with ±5% of UN.

3-phase TEFV induction motors LS aluminium alloy frame Operation

D2 - Supply voltage

D2.2.2 - Simultaneous variation of voltage and frequency

Within the tolerances defined in IEC guide 106 (see section D2.1), machine input and performance are unaffected if the variations are of the same polarity and the voltage/frequency ratio U/f remains constant.

If this is not the case, variations in performance are significant and require the machine specification to be changed.

Variation in main motor parameters (approx.) within the limits defined in IEC Guide 106.

U/f	P_u	M	N	$\cos \varphi$	Efficiency
Constant	$P_u \frac{f'}{f}$	M	$N \frac{f'}{f}$	$\cos \varphi$ unchanged	Efficiency unchanged
Variable	$P_u \left(\frac{u'/u}{f'/f}\right)^2$	$M \left(\frac{u'/u}{f'/f}\right)^2$	$N \frac{f'}{f}$	Depends on level of saturation of machine	

M = minimum and maximum values of starting torque.

D2.2.3 - Use of 400V - 50 Hz motors on 460V - 60 Hz supplies

For a rated power at 60 Hz 20% greater than the rated power at 50 Hz, the main characteristics are modified according to the following variations, which necessitate replating of the motor:

- Efficiency increases by 0.5 - 3%
- Power factor increases by 0.5 - 3%
- Rated current decreases by 0 - 5%
- I_D / I_N increases by around 10%
- Slip and rated torque $M_N, M_D / M_N, M_M / M_N$ remain more or less constant

VERY IMPORTANT NOTE:

The motors defined in this catalogue which can be used with a 60 Hz supply, will NOT CONFORM with CSA or UL standards. To conform with these standards, a different type of construction is needed.

D2.2.4 - Use on supplies with U' voltages different from the voltages in the characteristics tables

In this case, the machine windings should be adjusted.

As a result, only the current values will be changed and become:

$$I' = I_{400V} \times \frac{400}{U}$$

D2.2.5 - Phase voltage imbalance

The phase imbalance for voltage is calculated as follows:

$$\% \text{ voltage imbalance} = 100 \times \frac{\text{maximum difference in voltage compared to average voltage value}}{\text{average voltage value}}$$

The effect on motor performance is summarized in the table opposite.

If this imbalance is known before the motor is purchased, it is advisable, in order to

establish the type of motor required, to apply the derating specified in standard IEC 60892, illustrated on the graph opposite.

Percentage imbalance	0	2	3.5	5
Stator current	100	101	104	107.5
% increase in losses	0	4	12.5	25
Temperature rise	1	1.05	1.14	1.28

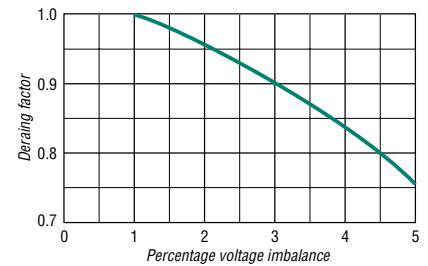

D2.2.6 - Phase current imbalance

Voltage imbalances induce current imbalances. Natural lack of symmetry due to manufacture also induces current imbalances.

The chart opposite shows the ratios in which the negative phase component is equal to 5% (and 3%) of the positive phase components in three-phase current supplies without zero components (neutral absent or not connected).

Inside the curve, the negative phase component is lower than 5% (and 3%).

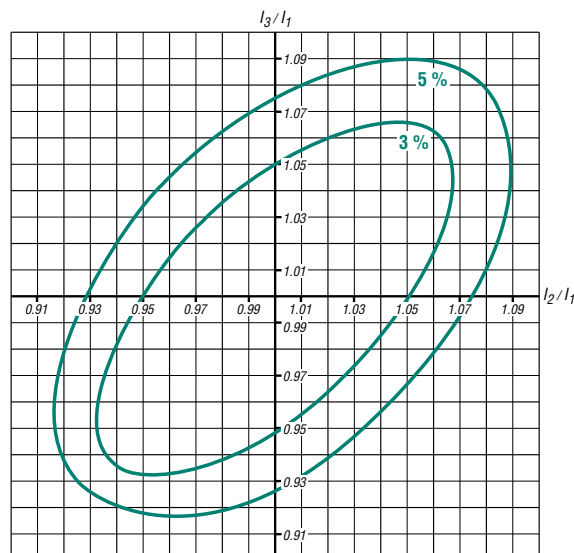

3-phase TEFV induction motors LS aluminium alloy frame Operation

D3 - Insulation class - Temperature rise and thermal reserve

Insulation class

The machines in this catalogue have been designed with a class F insulation system for the windings.

Class F allows for temperature rises of 105 K (measured by the resistance variation method) and maximum temperatures at the hot spots in the machine of 155 °C (Ref. IEC 60085 and IEC 60034-1).

Complete impregnation with tropicalized varnish of thermal class 180°C gives protection against attacks from the environment, such as: 90% relative humidity, interference, etc.

For special constructions, the winding is class H and impregnated with special varnishes which enable it to operate in conditions of high temperatures with relative air humidity of up to 100%.

Temperature rise (ΔT^*) and maximum temperatures at hot spots (T_{max}) for insulation classes (IEC 60034 - 1).

	ΔT^*	T_{max}
Class B	80 K	130°C
Class F	105 K	155°C
Class H	125 K	180°C

* Measured using the winding resistance variation method.

The insulation of the windings is monitored in two ways:

a - Dielectric inspection which involves checking the leakage current, at an applied voltage of $(2U + 1000)$ V, in conditions complying with standard IEC 60034-1 (systematic test).

b - Monitoring the insulation resistance between the windings and between the windings and the earth (sampling test) at a D.C. voltage of 500V or 1000V.

Temperature rise and thermal reserve

LEROY-SOMER motors are built to have a maximum winding temperature rise of 80 K under normal operating conditions (ambient temperature 40 °C, altitude below 1000 m, rated voltage and frequency, rated load).

Running at the voltage limit ($\pm 10\%$ of U_N) will induce overheating of less than 15 K.

In IEC 60034-1 and 60034-2, temperature rise ($\Delta\theta$) is calculated using the winding resistance variation method, with the formula:

$$\Delta T = \frac{R_2 - R_1}{R_1} (235 + T_1) + (T_1 - T_2)$$

R_1 : cold resistance measured at ambient temperature T_1

R_2 : stabilized hot resistance measured at ambient temperature T_2

235 : coefficient for a copper winding (for an aluminium winding, the coefficient is 225)

The result is a thermal reserve linked to the following factors:

- a difference of 25 K between the nominal temperature rise (U_n, f_n, P_n) and the permissible temperature rise (105 K) for class F insulation.
- a difference of over 20 K at the voltage limits ($U_n \pm 10\%$) between the actual temperature rise and the permissible temperature rise.

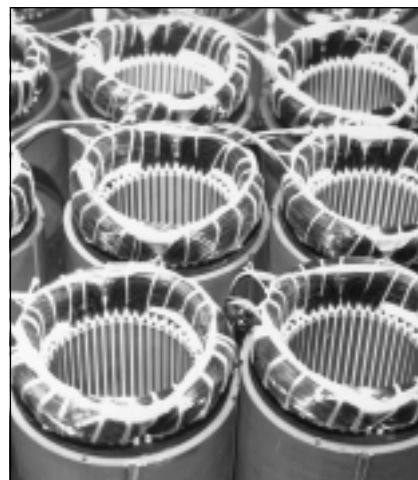

3-phase TEFV induction motors LS aluminium alloy frame Operation

D4 - Power - Torque - Efficiency - Power Factor (Cos φ)

D4.1 - DEFINITIONS

The output power (P_u) at the motor shaft is linked to the torque (M) by the equation:

$$P_u = M \cdot \omega$$

where P_u is in W, M is in N.m, ω is in rad/s and where ω is expressed as a function of the speed of rotation in min^{-1} by the equation:

$$\omega = 2\pi \cdot N/60$$

The active power (P) drawn from the mains is expressed as a function of the apparent

power (S) and the reactive power (Q) by the equation:

$$S = \sqrt{P^2 + Q^2}$$

(S in VA, P in W and Q in VAR)

The power P is linked to the output power P_u by the equation:

$$P = \frac{P_u}{\eta}$$

where η is the efficiency of the machine.

The output power P_u at the motor shaft is expressed as a function of the phase-to-phase mains voltage (U in Volts), of the line current absorbed (I in Amps) by the equation:

$$P_u = U \cdot I \cdot \sqrt{3} \cdot \cos\phi \cdot \eta$$

where $\cos\phi$ is the power factor found from the ratio:

$$\cos\phi = \frac{P}{S}$$

D4.2 - EFFICIENCY

In accordance with the agreements signed at the RIO and BUENOS AIRES INTERNATIONAL CONFERENCES, the new generation of motors with aluminium or cast iron frame has been designed to improve efficiency by reducing atmospheric pollution (carbon dioxide).

The improvement in efficiency of low voltage industrial motors (representing around 50% of installed power in industry) has had a large impact on energy consumption.

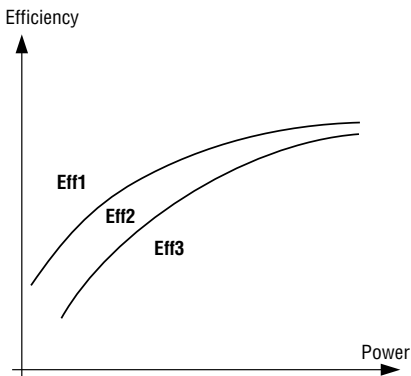

3 levels of efficiency Eff. 1-2-3 have been defined in a European agreement for 2 and 4-pole motors from 1.1 to 90 kW and this catalogue presents the reference range of LS Eff 2 motors.

Level Eff 3 in version LS is gradually being phased out of the LEROY-SOMER offer. **The Eff 1 level range is available on request.**

The European recommendation for measuring efficiency recommends testing using the separate losses method (in accordance with IEC 60034-2) on motors not fitted with bearing seals.



The advantages of improvement in efficiency:

Motor characteristics	Effects on the motor	Customer benefits
Increase in efficiency and in power factor.	Increase in specific output power.	Lower operating costs. Longer service life (x2 or 3). Better return on investment.
Noise reduction.		Improved working conditions.
Vibration reduction.		Quiet operation and longer service life of driven controls.
Temperature reduction.	Longer service life of fragile components (insulation system components, greased bearings).	Reduction in operating incidents and reduced maintenance costs.
	Increase in the capacity of instantaneous or extended overloads.	Wider field of applications (voltages, altitude, ambient temperature, etc).

D4.3 - INFLUENCE OF LOAD ON η AND POWER FACTOR $\cos\phi$

See the selection data in section E.

Overrating motors in a number of applications causes them to operate at about 3/4 load, resulting in optimum motor efficiency.

3-phase TEFV induction motors LS aluminium alloy frame Operation

D4 - Power - Torque - Efficiency - Power Factor (Cos φ)

D4.4 - TORQUE-SPEED CHARACTERISTICS

Below are torque/speed curves that correspond to a range of typical cases (different sizes of motor, no. of poles, etc).

M_{mot} is the average starting torque of the motor.

To find the accelerating torque, subtract the average load resistive torque from the average starting torque of the motor.

The curve numbers refer back to the electromagnetic characteristic selection tables in section E.

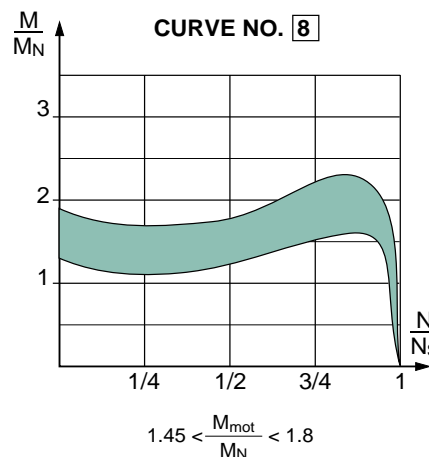
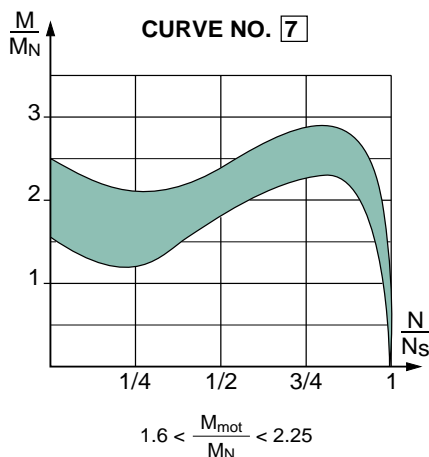
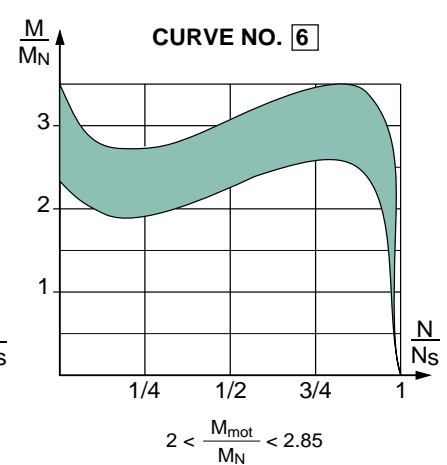
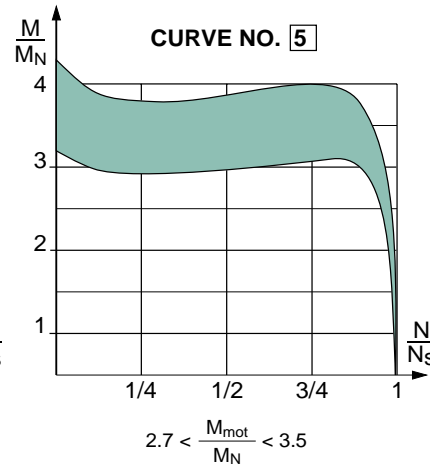
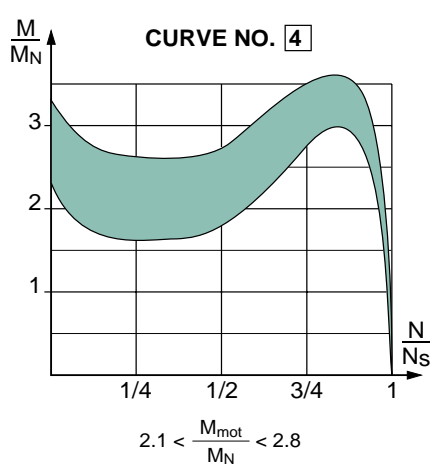
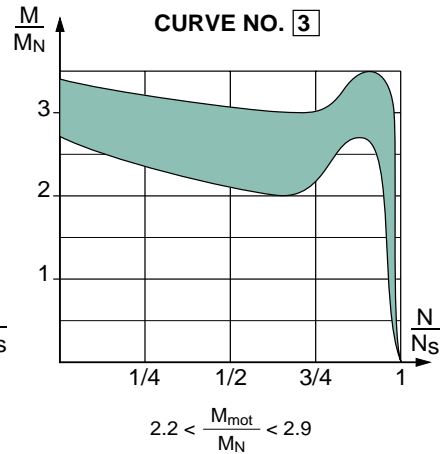
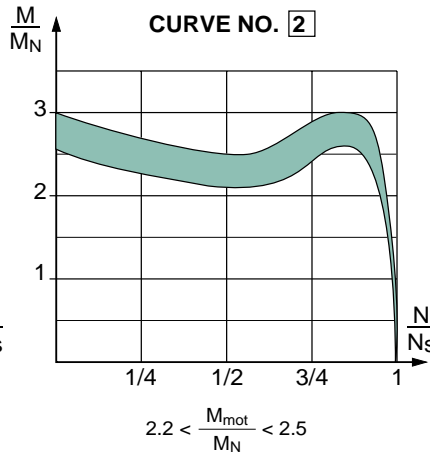
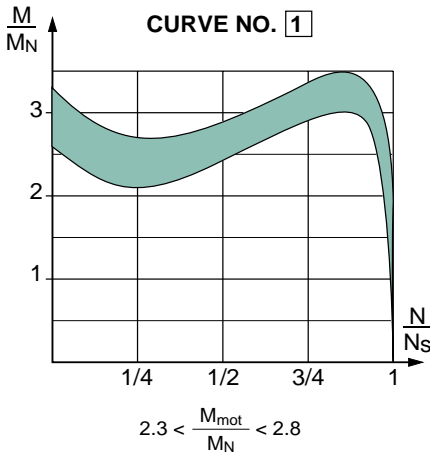

3-phase TEFV induction motors LS aluminium alloy frame Operation

D4 - Power - Torque - Efficiency - Power Factor (Cos φ)

D4.5 - CALCULATION OF ACCELERATING TORQUE AND STARTING TIME

Acceleration time can be calculated using a simplified formula:

$$t_d = \frac{\pi}{30} \frac{N \cdot J_N}{M_a}, \text{ where:}$$

t_d : is the acceleration time in seconds
 J_N = moment of inertia in kg.m² of the motor plus the load corrected, if necessary, to the speed of the shaft that develops the torque M_a

N : speed to be achieved in min⁻¹
 M_a or M_{acc} = the average accelerating torque in N.m (average torque developed by the motor during starting, reduced by the average resistive torque during the same period). In general, for centrifugal machines, a very good approximation can be written as follows:

$$M_a = \frac{M_D + 2M_A + 2M_M + M_N}{6} - M_r$$

The chart below may also be used:

Here again is the formula by which the moment of inertia of the driven machine turning at speed N' is equalized with the speed N of the motor.

$$J_N = J_{N'} \cdot \left(\frac{N'}{N}\right)^2$$

▼ Starting time calculation chart

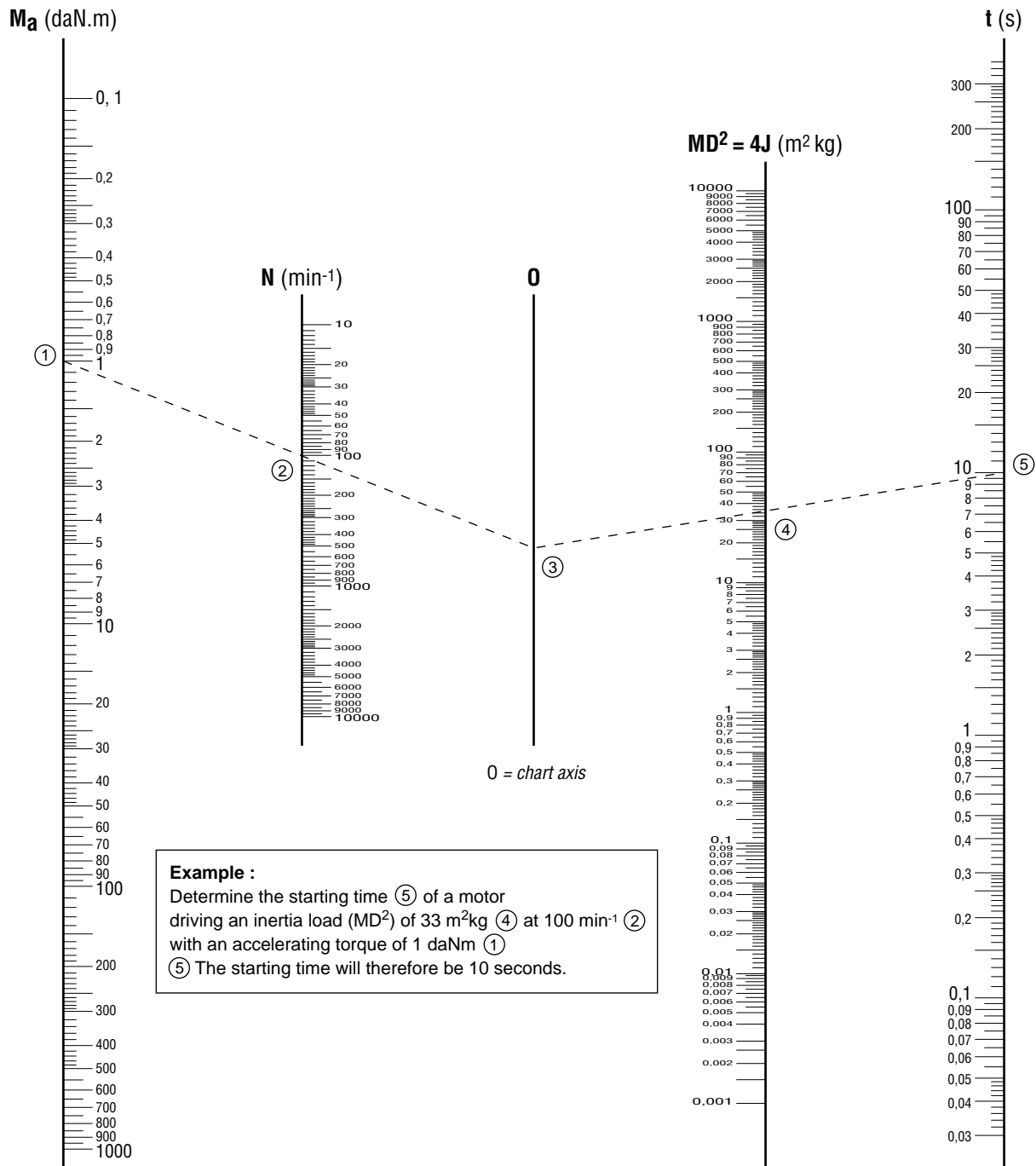

3-phase TEFV induction motors LS aluminium alloy frame Operation

D4 - Power - Torque - Efficiency - Power Factor (Cos φ)

Starting times and locked rotor times

The starting times calculated using the chart on the previous page must remain within the limits of the graph opposite which defines maximum starting times in relation to the starting current.

The rated motor power is also defined by the equation in section D4.6.1 according to the number of (equivalent) starts per hour.

Three successive cold starts and two consecutive warm starts are allowed.

Permissible motor starting time in relation to the ratio I_D/I_N for cold starts. ►

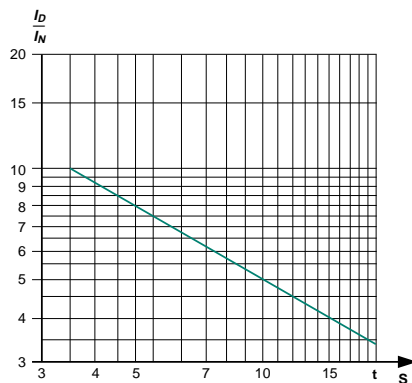

The table below gives locked rotor times at full voltage (exceptional operation, e.g. incident on the transmission) for the motor when warm and when cold:

Type	2 poles		4 poles		6 poles		8 poles	
	t (cold) s	t (warm) s	t (cold) s	t (warm) s	t (cold) s	t (warm) s	t (cold) s	t (warm) s
LS 56	10	4	15	6	-	-	-	-
LS 63	10	3.5	15	5	20	8	-	-
LS 71	10	3.5	15	5	20	8	30	11
LS 80	8	3	12	6	16	8	18	9
LS 90	6	3	9	5	18	9	30	11
LS 100	5	2.5	8	4	20	7	30	11
LS 112	5	2.5	5	2.5	11	5	25	9
LS 132	5	2.5	5	2.5	9	4	20	5
LS 160	9	3	15	5	20	8	25	10
LS 180	10	3.5	15	5	20	8	25	10
LS 200	12	4	15	5	20	8	25	10
LS 225	12	4	16	5	20	8	25	10
LS 250	13	4.5	17	6	20	8	25	10
LS 280	15	5	18	6	20	8	25	10
LS 315	15	5	18	6	20	8	25	10

3-phase TEFV induction motors LS aluminium alloy frame Operation

D4 - Power - Torque - Efficiency - Power Factor (Cos φ)

D4.6 - RATED POWER P_n IN RELATION TO DUTY CYCLE

D4.6.1 - General rules for standard motors

$$P_n = \sqrt{\frac{n \times t_d \times [I_D / I_n \times P]^2 + (3600 - n \times t_d) P_u^2 \times f_{dm}}{3600}}$$

Iterative calculation where:

- t_d(s) starting time of motor with power P_(w)
- n number of (equivalent) starts per hour
- OF operating factor (decimal)
- I_D/I_n starting current of motor with power P
- P_u (w) output power of motor during the duty cycle using OF (in decimal), operating factor
- P (w) rated power of motor selected for the calculation

Note: n and OF are defined in section D4.6.2.

Sp = specification

S1	OF = 1; n ≤ 6
S2	; n = 1 length of operation determined by Sp
S3	OF according to Sp ; n ~ 0 (temperature rise not affected by starting)
S4	OF according to Sp ; n according to Sp; t _d , P _u , P according to Sp (replace n with 4n in the above formula)
S5	OF according to Sp ; n = n starts + 3 n brakings = 4 n; t _d , P _u , P acc. to Sp (replace n with 4n in the above formula)
S6	$P = \sqrt{\frac{\sum (P_i^2 \cdot t_i)}{\sum t_i}}$
S7	same formula as S5 but OF = 1
S8	at high speed, same formula as S1 at low speed, same formula as S5
S9	S8 duty formula after complete description of cycle with OF on each speed
S10	same formula as S6

In addition, see the warning regarding precautions to be taken. Variations in voltage and/or frequency greater than standard should also be taken into account. The application should also be taken into account (general at constant torque, centrifugal at quadratic torque etc).

D4.6.2 - Determination of the power in intermittent duty cycles for adapted motors

rms power in intermittent duty

This is the rated power absorbed by the driven machine, usually defined by the manufacturer.

If the power absorbed by the machine varies during a cycle, the rms power P is calculated using the equation:

$$P = \sqrt{\frac{\sum_1^n (P_i^2 \cdot t_i)}{\sum_1^n t_i}} = \sqrt{\frac{P_1^2 \cdot t_1 + P_2^2 \cdot t_2 + \dots + P_n^2 \cdot t_n}{t_1 + t_2 + \dots + t_n}}$$

if, during the working time the absorbed power is:

$$\begin{array}{l} P_1 \text{ for period } t_1 \\ P_2 \text{ for period } t_2 \\ \dots \\ P_n \text{ for period } t_n \end{array}$$

Power values lower than 0.5 P_N are replaced by 0.5 P_N in the calculation of rms power P (no-load operation is a special case).

Additionally, it is also necessary to check that for a particular motor of power P_N:

- the actual starting time is at most equal to 5 seconds
- the maximum output of the cycle does not exceed twice the rated output power P
- there is still sufficient accelerating torque during the starting period

Load factor (LF)

Expressed as a percentage, this is the ratio of the period of operating time with a load during the cycle to the total duration of the cycle where the motor is energized.

Operating factor (OF)

Expressed as a percentage, this is the ratio of the motor power-up time during the cycle to the total cycle time, provided that the total cycle time is less than 10 minutes.

Starting class

$$\text{Class: } n = n_D + k \cdot n_F + k' \cdot n_i$$

n_D is the number of complete starts per hour
n_F is the number of times electrical braking is applied per hour

"Electrical braking" means any braking directly involving the stator winding or the rotor winding:

- Regenerative braking (with frequency controller, multipole motor, etc)
- Reverse-current braking (the most commonly used)
- D.C. injection braking

n_i is the number of impulses (incomplete starts up to one-third of maximum speed) per hour.

k and k' are constants determined as follows:

	k	k'
Cage induction motors	3	0.5

- Reversing the direction of rotation involves braking (usually electrical) and starting.

- Braking with LEROY-SOMER electro-mechanical brakes, as with any other brakes that are independent of the motor, does not constitute electrical braking in the sense described above.

Calculating derating

- Input criteria (load)
 - rms power during the cycle = P
 - Moment of inertia corrected to speed of motor = J_e
 - Operating factor = OF
 - Class of starts per hour = n
 - Resistive torque during starting = M_r

- Selection in catalogue
 - Motor power rating P_N
 - Starting current I_d, cos φ_D
 - Moment of inertia of rotor J_r
 - Average starting torque M_{mot}
 - Efficiency at P_N (η_{P_N}) and at P (η_P)

Calculations

- Starting time:

$$t_d = \frac{\pi}{30} \cdot N \cdot \frac{(J_e + J_r)}{M_{mot} - M_r}$$

- Cumulative starting time per hour:

$$n \times t_d$$

- Energy to be dissipated per hour during starts = sum of the energy dissipated in the rotor (= inertia acceleration energy) and the energy dissipated in the stator during the cumulative starting time per hour:

$$E_d = \frac{1}{2} (J_e + J_r) \left(\frac{\pi \cdot N}{30} \right)^2 \times n + n \times t_d \cdot \sqrt{3} U I_d \cos \phi_d$$

- Energy to be dissipated during operation

$$E_f = P \cdot (1 - \eta_P) \cdot [(OF) \times 3600 - n \times t_d]$$

- Energy that the motor can dissipate at rated power with the Operating Factor for Intermittent Duty.

$$E_m = (OF) \cdot 3600 \cdot P_N \cdot (1 - \eta_{PN})$$

(The heat dissipated when the motor is at rest can be ignored).

Dimensioning is correct if the following relationship is verified =

$$E_m \geq E_d + E_f$$

If the sum of E_d + E_f is lower than 0.75 E_m, check whether a motor with the next lowest power would be more suitable.

D4.6.3 - Equivalent thermal constant

The equivalent thermal constant enables the machine cooling time to be predetermined.

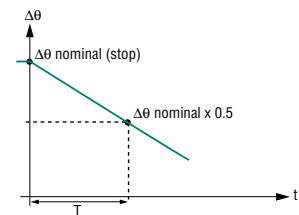

$$\text{Thermal constant} = \frac{T}{\ln 2} = 1.44 T$$

Cooling curve Δθ = f(t)

where Δθ = temperature rise in S1 duty

T = time required for nominal

temperature rise to reach

half its value

t = time

ln = natural logarithm

D4.6.4 - Transient overload after operating in type S1 duty cycle

At rated voltage and frequency, the motors can withstand an overload of:

1.20 for an OF = 50%

1.40 for an OF = 10%

However, it is necessary to ensure that the maximum torque is much greater than 1.5 times the rated torque corresponding to the overload.

3-phase TEFV induction motors LS aluminium alloy frame Operation

D4 - Power - Torque - Efficiency - Power Factor (Cos φ)

D4.7 - OPERATION OF A 3-PHASE MOTOR FROM A SINGLE-PHASE POWER SUPPLY (STEINMETZ CONNECTION)

It is possible to run three-phase motors from a single-phase power supply under certain conditions:

- a low-power (ie. low kW) motor, wound for 230/400 V - 50 Hz
- single-phase supply 220/230 V - 50 Hz
- derated for power
- loss of thermal reserve
- starting torque approx. 1.5 times the rated torque

Only 4-pole motors have suitable characteristics (starting current, power factor and efficiency, both for the supply and the machine lifetime).

Please consult Leroy-Somer about machines for other speeds.

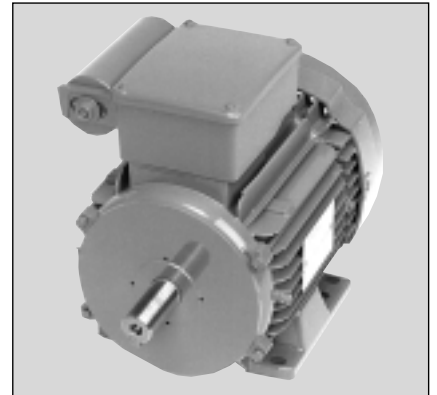
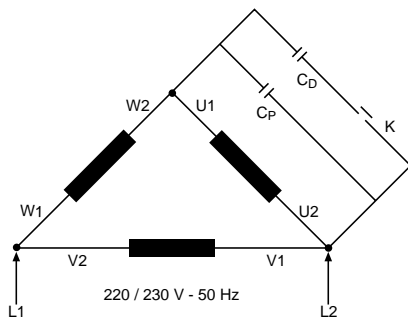

Table of characteristics

Motor type	P _{3-ph} kW	P _{1-ph} kW	C _D μF - 150V	C _p μF - 220V	Efficiency %	Cos φ	I _n amp for 230V	I _D amp for 230V
LS 80 L	0.55	0.37	120	30	80	0.91	2.2	11.5
LS 80 L	0.75	0.55	225	32	80	0.91	3.3	18
LS 90 L	1.1	0.75	300	47	79	0.99	4.2	25
LS 90 L	1.5	1.1	500	75	81	0.97	6.1	38
LS 100 L	2.2	1.5	560	90	80	0.98	8.3	45
LS 100 L	3	2.2	650	140	80	0.98	12.2	60
LS 112 M	4	3	1100	250	83	0.92	17	90

Circuit diagram



C_p : permanent capacitor

C_D : starting capacitor

K : circuit breaker relay contact for starting capacitors

External wiring diagram

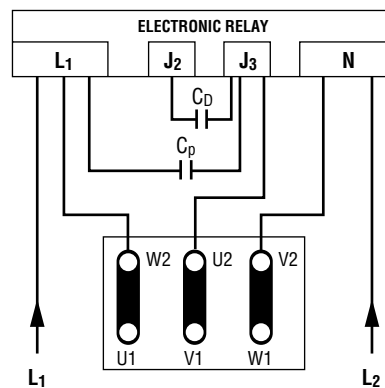

Note: to change the direction of rotation, connect W₂ to N

V₂ to L₁

Internal wiring diagram

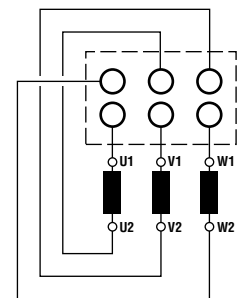

3-phase TEFV induction motors LS aluminium alloy frame Operation

D5 - Speed of rotation

D5.1 - SINGLE FIXED SPEED MOTOR

The great majority of applications only require a single fixed speed. If this applies to you, you should opt for a 1500 min⁻¹ or possibly 3000 min⁻¹ motor (50 Hz supply) which are the ones most frequently used.

However, even with fixed speeds there are two types of application which fall outside the standard speed range of 750 to 3000 min⁻¹.

D5.1.1 - High speed motor

High speed motors, operating at speeds of over 3000 min⁻¹, obtained by using supplies with fixed frequencies other than 50 Hz, for example 100, 200 or 400 Hz: the motor will run at a synchronous speed N such that:

$$N = \frac{120}{p} \cdot f$$

(N is in min⁻¹; f is the frequency of the supply in Hz; p is the number of motor poles). Motors of this type have to be specially designed, taking into account the following important points:

- the wave form of the high frequency supply (type of harmonics and total harmonic distortion)

- increased magnetic losses in relation to frequency and harmonics

- mechanical properties of rotors

- bearing properties, lubrication, lifetime, temperature rises, reduced currents

- ventilation, noise levels, vibrations

- starting current, motor torque, load inertia

It should also be noted that high speed applications are limited to smaller machines: the higher the speed, the smaller the machine must be.

D5.1.2 - Low speed motor

Low speed motors, running at under 750 min⁻¹. Low speeds are obtained either by using a supply with a fixed frequency of under 50 Hz, or by using more than 8 poles with a 50 Hz supply. Motors of this type also have to be specially designed to deal with the problems involved in this type of application, such as:

- resistive torque and driven inertia

and in the manufacture:

- ventilation

The most widely used fixed frequency (50 Hz) low speeds are 600 min⁻¹ (10-pole motor), 500 min⁻¹ (12-pole motor) and 375 min⁻¹ (16-pole motor).

The table below shows available power for each type of motor used in Type S1 duty, with a power supply of U_N ±5%, and a temperature rise of 100 K for a class F construction (quadratic torque application):

Type	10 p	12 p	16 p
LS 80 L	0.15	0.12	-
LS 90 S	0.25	0.17	0.07
LS 90 L	0.37	0.25	0.11
LS 100 L	0.5	0.37	0.17
LS 112 MG	0.9	0.75	0.25
LS 132 SM	1.1	0.9	0.5
LS 132 M	2.2	1.5	0.75
LS 160 M	4	2.2	1.1
LS 160 L	-	3	-
LS 160 LU	5.5	-	1.7
LS 180 L	7.5	4	2.2 - 3
LS 180 LU	-	5.5	-
LS 200 L	9	7.5	4
LS 200 LU	11 - 13 and	9	5.5
LS 225 MG	18.5	11 - 13 and	7.5
LS 225 MH	22	18.5	9

D5.2 - MULTIPLE FIXED SPEEDS MOTOR

Some applications require operation at two or three fixed speeds. These can be obtained by changing the poles in a multi-speed motor. There are a large number of solutions, but we shall only look at the following:

D5.2.1 - Motor with single winding

Motors with a single winding (Dahlander connection [speed ratio: 2:1]) or PAM (any speed ratio):

Internal connection of stator windings is used for specific applications:

centrifugal { Dahlander Y - Y or Δ - Δ applications PAM - Y

other applications - Dahlander Δ - Y

In general, these motors are designed for D.O.L. starting from the mains supply and are single-voltage.

The most common speed ratios are:

- 3000 / 1500 min⁻¹ (2 / 4 poles)
- 1500 / 750 min⁻¹ (4 / 8 poles)

Recommendation for using motors with PAM winding

The following precautions should be taken when connecting PAM 2-speed motors operated in parallel on a single installation to the mains supply:

1 - All motors should be of the same construction and come from the same supplier.

2 - The sequence of the R, S, T phases of the supply should be marked.

3 - Terminals with the same name [(1U1, 1V1, 1W1), (2U1, 2V1, 2W1)] on each motor should be connected together on a single-phase.

Note: If one of the motors rotates in a different direction to the others, this motor should be returned to the factory to bring it into conformity.

Example: 2 motors with 4/6 poles operating in parallel.

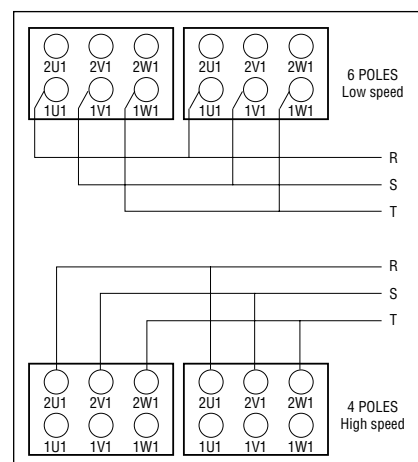

D5.2.2 - Motor with separate windings

Motors with two separate windings. Different starts are obtained depending on the winding connections on the terminal block:

2 x 3 terminals: Direct-On-Line (D.O.L.) starting

2 x 6 terminals: Y / Δ starting possible

In the first case, these motors will be single-voltage; in the second, they may be either dual-voltage or Y / Δ starting single-voltage motors.

The most common speed ratios

are:

- 3000 / 750 min⁻¹ (2 / 8 poles)
- 1500 / 1000 min⁻¹ (4 / 6 poles)

3-phase TEFV induction motors LS aluminium alloy frame Operation

D5 - Speed of rotation

D5.2.3 - Behaviour of two-speed motors

Each speed of a multi-speed motor behaves like a complete motor (curves ① and ②) with operation as a brake, a motor and an asynchronous generator, depending on the quadrant.

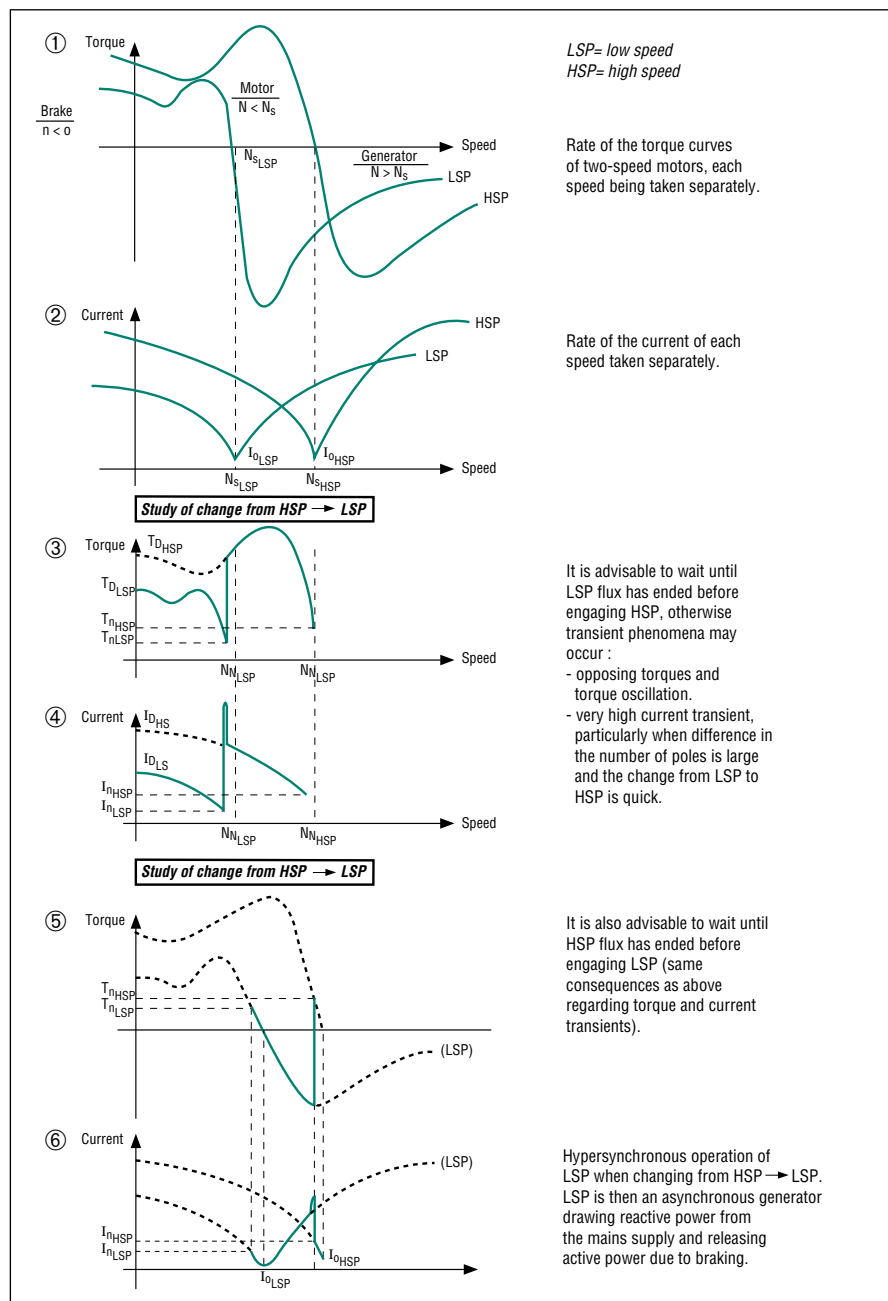

The above curves ③ to ⑥ explain how the torques and currents develop when the motor changes from low speed to high speed and vice versa.

Note: The greater the difference between the number of poles, the more likelihood of:

- significant current peak at LSP
- long braking time and risk of temperature rise at LSP
- high level of hypersynchronous noise

Some of these phenomena can be aggravated if the driven inertia is high.

The rated power is determined according to the criteria in section D4.6.1 for each of the two speeds (see type S8 duty).

Manufacturers' recommendations should be followed regarding devices for connecting to the mains supply and protection, using equipment which has already been examined and for which the problems of transient current peaks have been resolved.

D5.2.4 - Operating rules

A few common sense rules need to be applied to get the best out of a two-speed motor:

- Avoid large differences in the number of poles (for example 2/12p, 2/16p, 4/20p, etc) : the torque drop at high speed occurs at a speed greater than the synchronous speed at low speed. The motor may start to "crawl" and never reach its higher speed rating.

- It is better to start the motor at the lower speed: this effectively eliminates the high speed torque drop, thus reducing the starting time. It will also limit current surge.

- As well as taking the precaution advised in the previous paragraph, current surge can be limited using the advice given in section D8 on "starting". Do bear in mind, though, that not all two-speed motors can be started using the suggested types of starting.

- An important precaution for motors with two separate windings, if the normal connection is a delta, is to "open" the delta for the speed not in use to avoid inducing circulating currents which can create opposing torques and harmful temperature rises.

D5.2.5 - 2-speed motors with connected windings

For ventilation applications, we manufacture 2-speed motors by connecting the windings on a single-speed motor:

- High speed by delta connection at full voltage.

- Low speed by star connection at full voltage.

The second speed is obtained because the motor is seriously desaturated (voltage divided by 1.732 at the phase terminals) and the rotor is experiencing a great deal of slip: as a result, there is a significant rotor temperature rise – since all the Joule losses due to the slip are dissipated in it – and risks of significant overheating – by conduction – in the windings if essential derating precautions have not been taken.

In fact, equilibrium is achieved for both speed and temperature rise by means of the following principles:

- The power varies in the same way as the speed power three.

- The slip varies as a function of the output and the temperature rise.

3-phase TEFV induction motors LS aluminium alloy frame Operation

D5 - Speed of rotation

- The choice of alloy for the rotor squirrel cage depends on the required output speeds.

When the power absorbed by the fan varies for reasons not related to the selected operating principle – for example, dirt on the fan blades, temperature of the air flow, variation of power supply frequency or voltage, etc. – the temperature rise in the rotor varies and allows speed equilibrium to be regained without making any adjustments (unless the variations exceed the maximum motor torque in the relevant connection).

The immediate consequence of these random conditions is to define the motor according to its load (driven inertia, power, speeds, etc) and to optimize the choice using real tests. The number of poles chosen for these applications should be four poles or more, and the power rating less than 7.5 kW with 4 poles. We do not offer actual motor ranges, but will undertake development work in a technical partnership.

D5.2.6 - Special cases

Motors with more than two speeds have to be specially designed, as, in the majority of cases, the precise nature of the load must be specified.

D5.3 - VARIABLE SPEEDS

Improvements in manufacturing processes have led to the introduction of variable speed control.

Two different processes can be used on motors:

- slip variation at fixed frequency
- supply frequency variation

D5.3.1 - Slip variation at fixed frequency

On a motor of a given build, slip other than the rated slip can be obtained by either increasing the load or decreasing the supply voltage.

As an increase in slip is accompanied by increased rotor losses, special rotors have now been designed for use in motors for very specific applications.

The most common application is the high-torque motor with a high-resistance rotor, used with variable voltage, providing constant torque within a specified range of speeds.

These motors have to be specially designed.

The family of curves below shows the variation in motor torque in relation to the supply voltage $U_N > U_1 > U_2$, etc.

The green curve shows the maximum torque available in relation to speed for a maximum temperature rise for the insulation class in Type S1 duty (normally with forced ventilation).

The dotted curve shows the maximum constant torque available in Type S1 duty in the speed range 0 to N_M .

The available powers and torques of these motors in Type S1 duty are much lower than those of standard motors of the same type.

▼ Characteristic curves of a high-torque motor

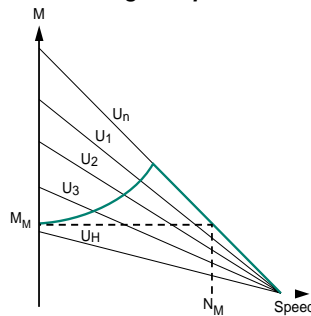

- Family of curves $M = f(N)$ at different voltages
- Maximum use in S1 type duty
- M_M maximum constant torque from 0 to N_M in S1 type duty

D5.3.2 - Frequency variation

In induction motors, variations of speed within a wide range are obtained using a power supply with variable frequency and voltage.

As a general rule, the frequency inverter delivers a proportional voltage and frequency up to a value F_1 , which depends on the manufacturer, and a fixed voltage up to a maximum frequency value of F_2 .

In these conditions, the motor output is proportional to the frequency up to the value F_1 (F_1 = frequency where the U/f ratio changes), and then constant up to the value F_2 .

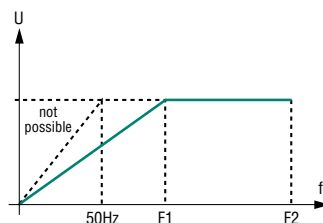

In practice, certain adjustments have to be made. At low frequency, to maintain significant torque, the inverter provides greater saturation of the motor (and thus a higher U value); the value of F_1 is itself made variable so as to widen the range of use at constant torque (or at proportional power).

In addition, forced ventilation enhances motor cooling at low speeds and reduces noises levels at high speeds.

In applications where accurate speed regulation is required, the variable speed drive can be used with closed-loop feedback by fitting a speed detector (D.C. tacho, A.C. tacho or encoder) which will send a signal to the inverter to change its U/f ratio and so regulate the speed at the level required (see curve below).

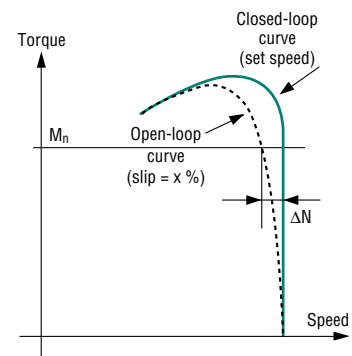

Using induction motors at high speeds (over about 4000 min^{-1}) can be risky. The cage may be damaged, bearing life impaired, as well as vibration and high-frequency saturation leading to heavy losses and significant temperature rises, etc. An in-depth mechanical and electrical design exercise is needed for all machines required to operate at speeds of over 4000 min^{-1} .

High-speed motors often need to be adapted to suit their application, and this work may include:

- fitting a speed detector (D.C. tacho, A.C. tacho or encoder)
- fitting forced ventilation
- fitting a brake or decelerator

3-phase TEFV induction motors LS aluminium alloy frame Operation

D5 - Speed of rotation

Applications and choice of solutions

There are three main types of load:

a - Centrifugal machines

The output torque varies as the square of the speed. The torque required for acceleration is low (about 20% of rated torque).

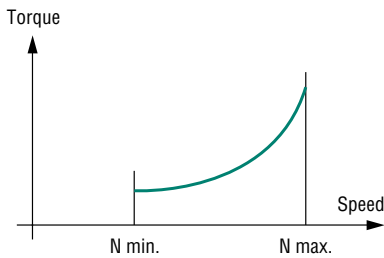

b - Constant torque applications

The output torque remains constant throughout the speed range. The torque required for acceleration may be high, depending on the machine (higher than the rated torque).

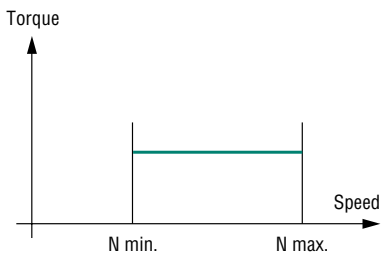

c - Constant power applications

The output torque decreases as the speed increases. The torque required for acceleration is at most equal to the rated torque.

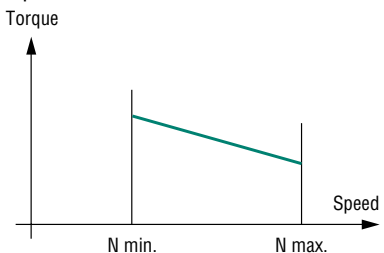

These applications involve a choice of motor-drives based on the following criteria:

- Centrifugal machines: torque or power at the maximum operating speed.
- Applications with constant torque: range of operating speeds and output torques.
- Applications with constant power: range of operating speeds and torque at the minimum operating speed.

Choice of inverter/motor combination

The curve below expresses the output torque of a 2, 4 or 6 pole motor supplied by a drive with power P where F_1 is 50 Hz (point at which U/f ratio changes).

For a frequency inverter with power P_N operating at constant power P within a determined range of speeds, it is possible to optimize the choice of motor and its number of poles to give a maximum amount of torque.

Example 1: the UMV - 3.5 T inverter (drive) can supply the following motors:

- LS 90 - 2 p - 2.2 kW - 7.5 N.m
- LS 100 - 4 p - 2.2 kW - 15 N.m
- LS 112 - 6 p - 2.2 kW - 22.5 N.m

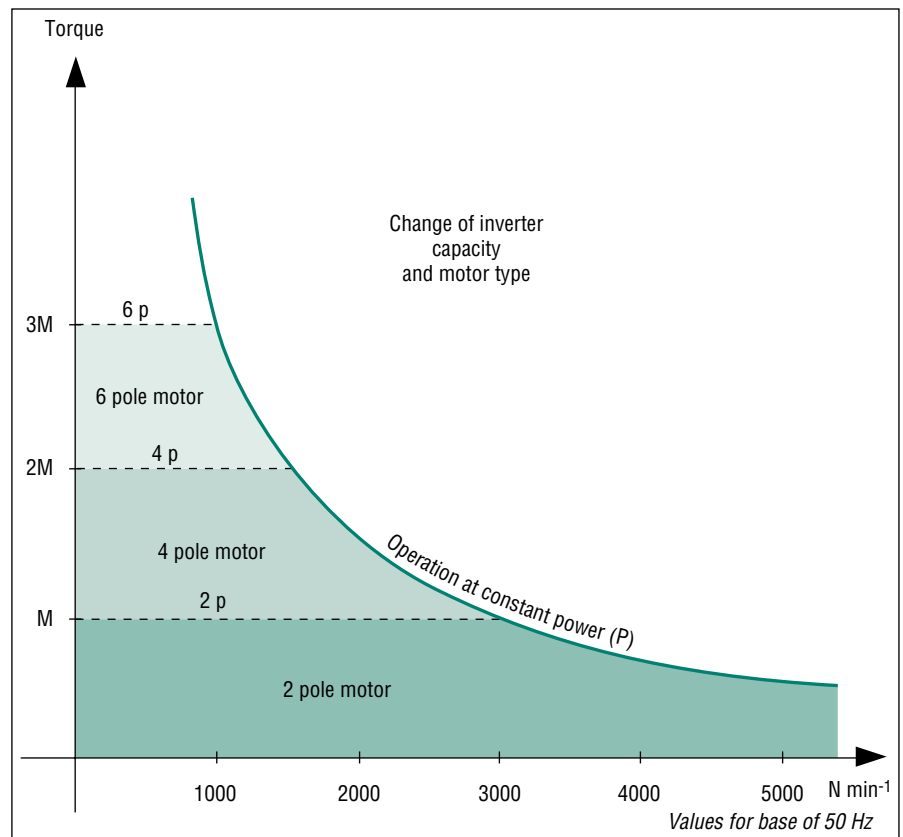

The choice of the motor and inverter combination will therefore depend on the application.



3-phase TEFV induction motors LS aluminium alloy frame Operation

D5 - Speed of rotation

Extreme operating conditions and other points

Coupling motors

For this type of application, we strongly recommend a Y connection for the windings to reduce the effects of disconnection from the mains supply.

Transient overloads

Drives are designed to withstand transient overload peaks of 180% or overloads of 150% for 60 seconds (maximum once every ten minutes). If the overload is greater, the system will automatically shut down.

Starting torque and current

The specific U/f ratio (with Boost for frequencies lower than 25 Hz), the torque available when the motor is switched on can be adjusted to a value higher than the rated value.

Adjusting the switching frequency

This optimizes motor noise levels by adapting the wave form to the specific type of use.

Electrical protection

The system all have integrated features to protect them against:

- overload (over-current)
- under-voltage and over-voltage
- short-circuit
- earth fault

Note: All the above faults are shown on an LCD screen, as are settings, speed and current ranges, etc.

Mechanical speed limits for standard motors when the frequency is varied (min^{-1})

With increasingly extensive frequency ranges, frequency inverters can, in theory, control a motor at a higher speed than its rated speed. However, the bearings and type of balancing of the standard rotor dictate a maximum mechanical speed which cannot be exceeded without endangering the service life of the motor (please consult Leroy-Somer for each application).

Choice of motor

There are two possibilities:

a - The frequency inverter is not supplied by LEROY-SOMER

All the motors in this catalogue can be used with a frequency inverter. Depending on the application, motors will need to be derated by around 10% to maintain all the characteristics described in this catalogue.

To avoid changes in frame size due to derating within the standard range, LEROY-SOMER has developed a range of adapted motors with standardized dimensions. What is more, the improved efficiency of this range means that the motors can be used with an electronic drive without derating.

b - The frequency inverter is supplied by LEROY-SOMER

LEROY-SOMER has developed a range of optimized motors together with a range of frequency inverters.

As these two ranges have been specifically designed for use in combination, excellent performance is guaranteed.

There is a special catalogue devoted to this product line (LSMV Motors).

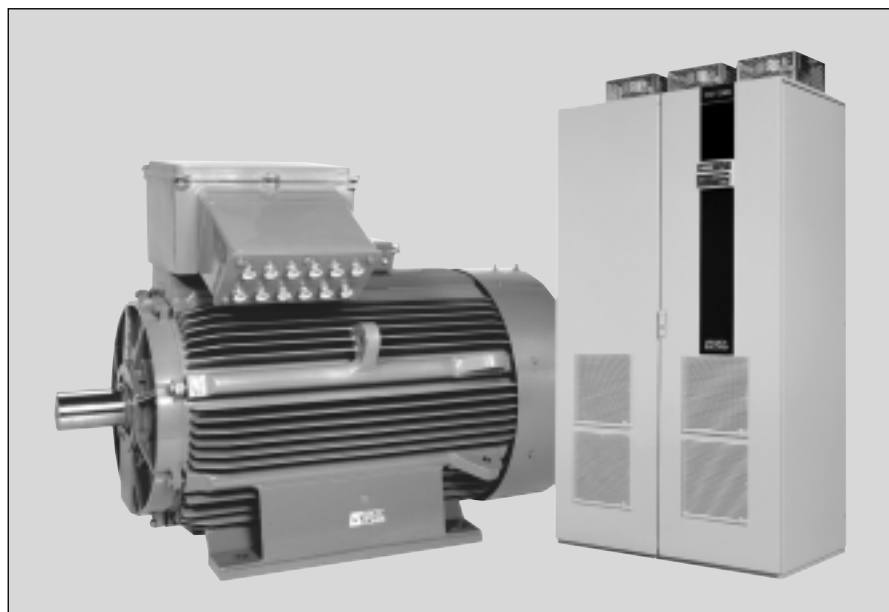

3-phase TEFV induction motors LS aluminium alloy frame Operation

D6 - Noise and vibration

D6.1 - MOTOR NOISE LEVELS

D6.1.1 - Noise emitted by rotating machines

In a compressible medium, the mechanical vibrations of an elastic body create pressure waves which are characterized by their amplitude and frequency. The pressure waves constitute an audible noise if they have a frequency of between 16 and 16000 Hz.

Noise is measured by a microphone linked to a frequency analyser. Measurements are taken in an anechoic chamber on machines at no-load, and a sound pressure level L_p or a sound power level L_w can then be established. Measurement can also be carried out in situ on machines which may be on-load, using an acoustic intensity meter which can differentiate between sound sources and identify the sound emissions from the machine.

The concept of noise is linked to hearing. The auditory sensation is determined by integrating weighted frequency components with isosonic curves (giving a sensation of constant sound level) according to their intensity.

The weighting is carried out on sound meters using filters whose bandwidth takes into account, to a certain extent, the physiology of the human ear:

Filter A: used for low and medium noise levels. High attenuation, narrow bandwidth.

Filter B: used for very high noise levels. Wide bandwidth.

Filter C: very low attenuation over the whole of the audible frequency range.

Filter A is used most frequently for sound levels emitted by rotating machinery. It is this filter which has been used to establish the standardized characteristics.

A few basic definitions:

The unit of reference is the bel, and the sub-multiple decibel dB is used here.

Sound pressure level in dB

$$L_p = 20 \log_{10} \left(\frac{P}{P_0} \right) \text{ where } P_0 = 2.10^{-5} \text{ Pa}$$

Sound power level in dB

$$L_w = 10 \log_{10} \left(\frac{P}{P_0} \right) \text{ where } P_0 = 10^{-12} \text{ W}$$

Sound intensity level in dB

$$L_w = 10 \log_{10} \left(\frac{I}{I_0} \right) \text{ where } I_0 = 10^{-12} \text{ W/m}^2$$

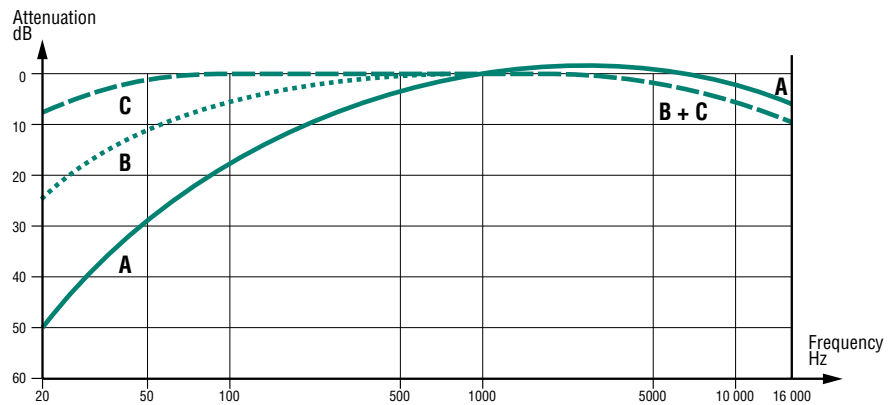

Correction of measurements

For differences of less than 10 dB between 2 sound sources or where there is background noise, corrections can be made by addition or subtraction using the rules below.

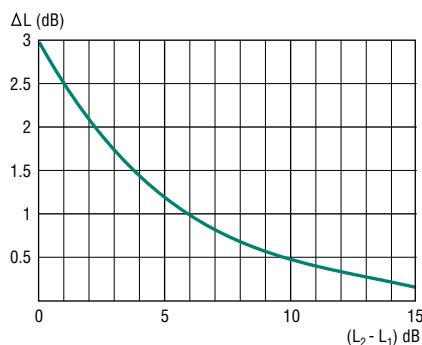

Addition of levels

If L_1 and L_2 are the separately measured levels ($L_2 \geq L_1$), the resulting sound level L_R will be obtained by the formula:

$$L_R = L_2 + \Delta L$$

ΔL is found by using the curve above ▲

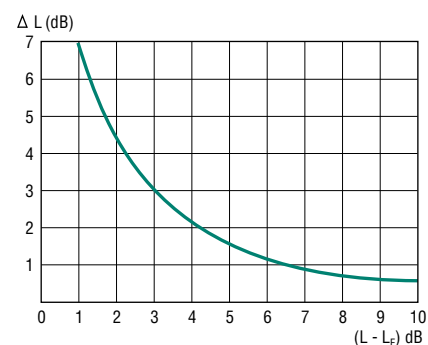

Subtraction of levels*

This is most commonly used to eliminate background noise from measurements taken in a "noisy" environment.

If L is the measured level and L_f the background noise level, the actual sound level L_R will be obtained by the calculation:

$$L_R = L - \Delta L$$

ΔL is found by using the curve above ▲

*This method is the one normally used for measuring sound power and pressure levels. It is also an integral part of sound intensity measurement.

3-phase TEFV induction motors LS aluminium alloy frame Operation

D6 - Noise and vibration

Under IEC 60034-9, the guaranteed values are given for a machine operating at no-load under normal supply conditions (IEC 60034-1), in the actual operating position, or sometimes in the

direction of rotation as specified in the design.

This being the case, standardized sound power level limits are shown for the values obtained for the machines described in this

catalogue. (Measurements were taken in conformity with standard ISO 1680).

Weighted sound level [dB(A)] of motors in position IM 1001 with a 50 Hz supply

Expressed as sound power level (L_w) according to the standard, the level of sound is also shown as sound pressure level (L_p) in the table below:

Motor type	2 poles			4 poles			6 poles			8 poles		
	IEC 60034-9	LS	LS	IEC 60034-9	LS	LS	IEC 60034-9	LS	LS	IEC 60034-9	LS	LS
	Power L _w A	Pressure	Pressure	Power L _w A	Pressure	Pressure	Power L _w A	Pressure	Pressure	Power L _w A	Pressure	Pressure
LS 56 L	-	62	54	-	55	47	-	-	-	-	-	-
LS 63 M	-	65	57	-	58	49	-	57	48	-	-	-
LS 71 L	-	70	62	-	58	49	-	60	52	-	48	40
LS 80 L	81	69	61	-	55	47	-	49	41	-	49	41
LS 90 S	81	74	66	71	57	49	-	59	51	-	51	43
LS 90 L	81	74	66	71	57	49	71	59	51	-	51	43
LS 100 L	86	75	66	76	57	48	71	59	50	71	52	43
LS 112 M	86	75	66	76	58	49	71	60	51	71	58	49
LS 132 S	91	81	72	81	67	58	76	64	55	71	60	51
LS 132 M	91	81	72	81	71	62	76	64	55	76	63	54
LS 160 M	91	82	72	88	72	62	80	66	56	76	76	66
LS 160 L	94	82	72	88	72	62	80	66	56	80	76	66
LS 180 M	96	82	72	88	74	64	-	-	-	-	-	-
LS 180 L	-	-	-	91	75	64	84	71	60	80	79	68
LS 200 L	96	84	73	91	75	64	84	73	62	84	75	65
LS 225 S	98	84	73	94	75	64	-	-	-	84	75	65
LS 225 M	98	84	73	94	75	64	87	74	63	84	75	65
LS 250 M	100	87	76	94	77	66	87	76	65	89	74	63
LS 280 S	100	89	79	97	80	69	90	76	65	89	74	63
LS 280 M	100	90	79	97	80	69	90	76	65	89	74	63
LS 315 S	100	95	83	97	82	70	94	85	73	89	86	74
LS 315 M	103	95	83	101	82	70	94	86	74	92	86	74
LS 315 MR	103	95	83	101	86	74	94	86	74	-	-	-

The maximum tolerance for these values is + 3 dB(A).

In compliance with standards IEC 60034-9 and NFEN ISO 4871, uncertainty on machine installations is established using the formula:

$$L_p = L + k$$

where 1.5 < k < 6 dB depending on whether laboratory or control measurements are being used.

The noise levels of these motors with a 60 Hz supply with proportional voltage are increased by about 2 dB(A) with 8 poles, to about 6 dB(A) with 2 poles.

D6.1.2 - Noise levels for machines at full load

Sound power levels, when at full load, are usually higher than those when at no-load. The maximum increase at full load to be added to the declared values at no-load is between 2 and 8 dB(A). (Addition to standard IEC 60034.9).



3-phase TEFV induction motors LS aluminium alloy frame Operation

D6 - Noise and vibration

The LS machines in this catalogue are classed N, half-key balancing

D6.2 - VIBRATION LEVELS - BALANCING

Inaccuracies due to construction (magnetic, mechanical and air-flow) lead to sinusoidal (or pseudo sinusoidal) vibrations over a wide range of frequencies. Other sources of vibration can also affect motor operation: such as poor mounting, incorrect drive coupling, end shield misalignment, etc.

We shall first of all look at the vibrations emitted at the operating frequency, corresponding to an unbalanced load whose amplitude swamps all other frequencies and on which the dynamic balancing of the mass in rotation has a decisive effect.

Under standard ISO 8821, rotating machines can be balanced with or without a key or with a half-key on the shaft extension. Standard ISO 8821 requires the balancing method to be marked on the shaft extension as follows:

- half-key balancing: letter H
- full key balancing: letter F
- no-key balancing: letter N

The machines in this catalogue are classed N - Classes R and S are available on request.

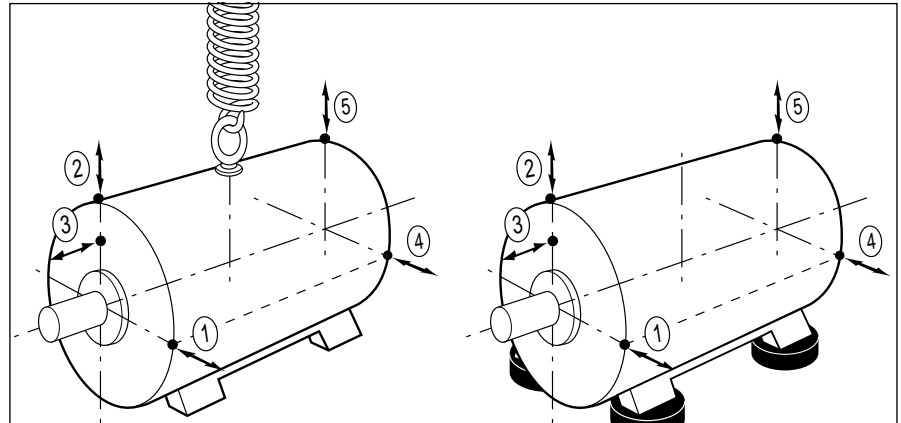

▲ Measuring system for suspended machines

▲ Measuring system for machines on flexible mountings

The measurement points quoted in the standards are the ones indicated in the drawings above.

At each point, the results should be lower than those given in the tables below for each balancing class and only the highest value is to be taken as the "vibration level".

Measured parameters

The vibration speed can be chosen as the variable to be measured. This is the speed at which the machine moves either side of its static position. It is measured in mm/s.

As the vibratory movements are complex and non-harmonic, it is the quadratic average (rms value) of the speed of vibration which is used to express the vibration level.

Other variables that could also be measured are the vibratory displacement amplitude (in μm) or vibratory acceleration (in m/s^2).

If the vibratory displacement is measured against frequency, the measured value decreases with the frequency: high-frequency vibrations are not taken into account.

If the vibratory acceleration is measured, the measured value increases with the frequency: low-frequency vibrations (unbalanced loads) cannot be measured.

The rms speed of vibration is the variable chosen by the standards.

However, if preferred, the table of vibration amplitudes may still be used (for measuring sinusoidal and similar vibrations).

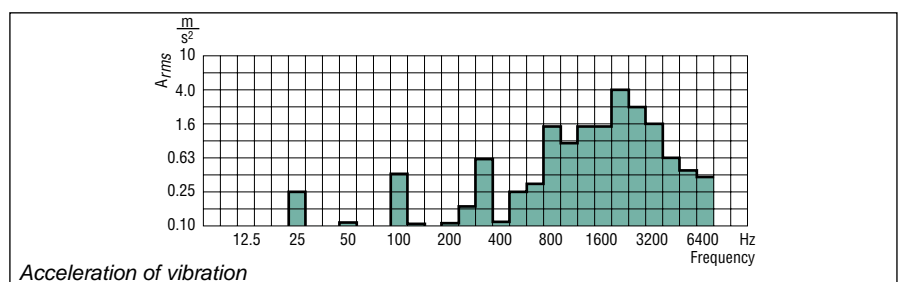
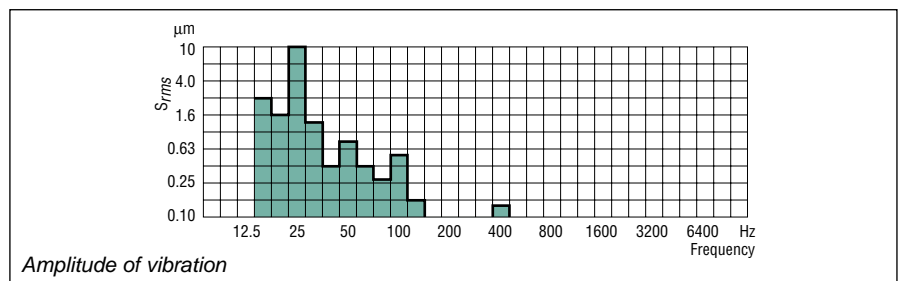
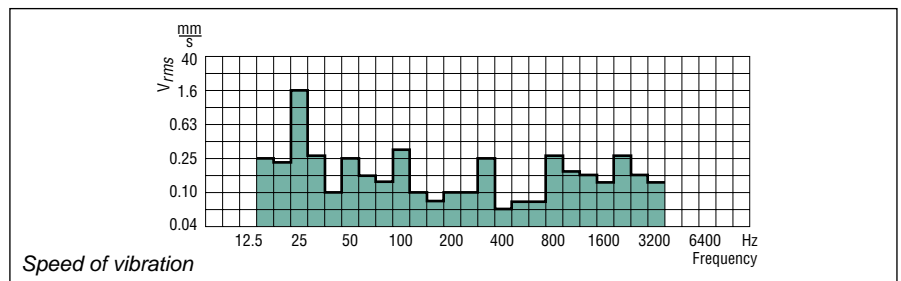

3-phase TEFV induction motors LS aluminium alloy frame Operation

D6 - Noise and vibration

Maximum value of rms speed of vibration expressed in mm/s (IEC 60034-14)
(machine tested when freely suspended)

Class	Speed N (min^{-1})	Frame size H (mm)		
		$H \leq 132$	$132 < H \leq 225$	$225 < H \leq 315$
N (normal)	$600 < N \leq 3600$	1.8	2.8	3.5
R (reduced)	$600 < N \leq 1800$	0.71	1.12	1.8
	$1800 < N \leq 3600$	1.12	1.8	2.8
S (special)	$600 < N \leq 1800$	0.45	0.71	1.12
	$1800 < N \leq 3600$	0.71	1.12	1.8

Maximum value of the simple displacement amplitude expressed in μm (for sinusoidal vibrations only)

Class	Speed N (min^{-1})	Frame size H (mm)		
		$H \leq 132$	$132 < H \leq 225$	$225 < H \leq 315$
N (normal)	1000	24	38	48
	1500	16	25	32
	3000	8	12.5	16
R (reduced)	1000	9	16	24
	1500	6.3	10	16
	3000	5	8	12.5
S (special)	1000	6.3	9	16
	1500	4	6.3	10
	3000	3.15	5	8

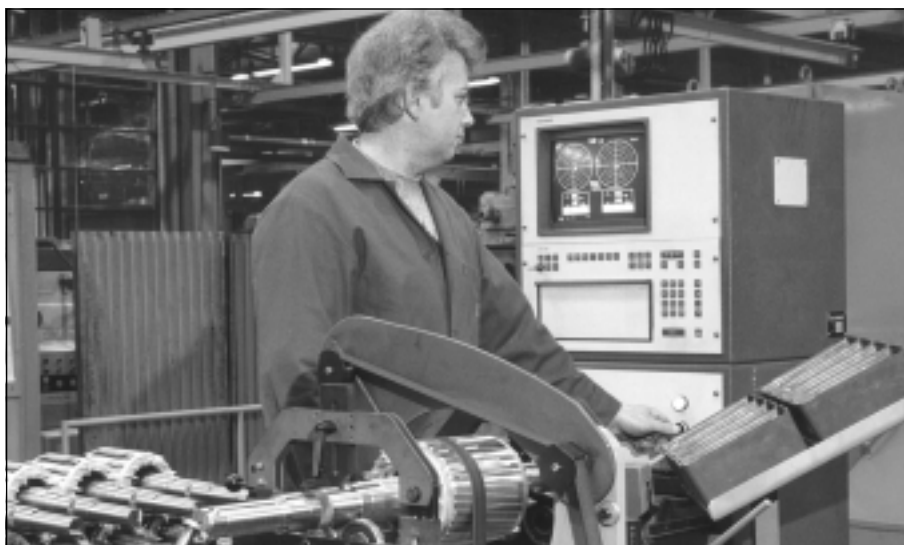

3-phase TEFV induction motors LS aluminium alloy frame Operation

D7 - Performance



D7.1 - THERMAL PROTECTION

Motors are protected by a manual or automatic overcurrent relay, placed between the isolating switch and the motor. This relay may in turn be protected by fuses. These protection devices provide total protection of the motor against non-transient

overloads. If a shorter reaction time is required, or if you want to detect transient overloads, or to monitor temperature rises at "hot spots" in the motor or at strategic points in the installation for maintenance purposes, it would be advisable to install heat sensors. The various types are shown in the table

below, with a description of each. It must be emphasized that sensors cannot be used to carry out direct adjustments to the motor operating cycles.

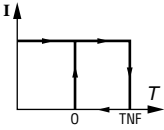
Built-in indirect thermal protection

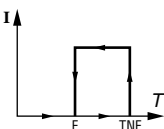
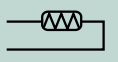
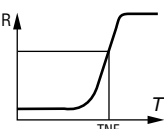
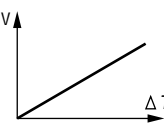
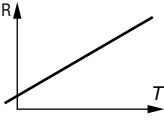
Type	Symbol	Operating principle	Operating curve	Cut-off (A)	Protection provided	Mounting Number of devices*
Normally closed thermostat	PTO	bimetallic strip, indirectly heated, with normally closed (NC) contact 		2.5 A at 250 V with $\cos \varphi 0.4$	general surveillance for non-transient overloads	2 or 3 in series
Normally open thermostat	PTF	bimetallic strip, indirectly heated, with normally open (NO) contact 		2.5 A at 250 V with $\cos \varphi 0.4$	general surveillance for non-transient overloads	2 or 3 in parallel
Positive temperature coefficient thermistor	PTC	Variable non-linear resistor with indirect heating 		0	general surveillance for transient overloads	3 in series
Thermocouples	T ($T < 150\text{ }^{\circ}\text{C}$) Copper Constantan K ($T < 1000\text{ }^{\circ}\text{C}$) Copper Copper-Nickel	Peltier effect		0	continuous surveillance at hot spots	1 per hot spot
Platinum resistance thermometer	PT 100	Variable linear resistor with indirect heating		0	high accuracy continuous surveillance at key hot spots	1 per hot spot

- NRT: nominal running temperature

- The NRTs are chosen according to the position of the sensor in the motor and the temperature rise class.

* The number of devices relates to the winding protection.

Fitting thermal protection

- PTO or PTF, in the control circuits
- PTC, with relay, in the control circuits
- PT 100 or Thermocouples, with reading equipment or recorder, in the control board of the installation for continuous surveillance.

Alarm and early warning

All protective equipment may be backed up by another type of protection (with different NRTs). The first device will then act as an "early warning" (light or sound signals given without shutting down the power circuits), and the second device will be the actual alarm (shutting down the power circuits).

Built-in direct thermal protection

For low rated currents, bimetallic strip-type protection may be used. The line current passes through the strip, which shuts down or restores the supply circuit as necessary. The design of this type of protection allows for manual or automatic reset.

3-phase TEFV induction motors LS aluminium alloy frame Operation

D7 - Performance

D7.2 - POWER FACTOR (COS φ) CORRECTION

To help improve current supply in the power lines, electricity supply distributors now ask their customers to have loads with a Power Factor (cos φ) as near as possible to 1 or at least higher than 0.93.

To create the magnetic field, induction motors absorb reactive power (Q) and introduce a Power Factor which may be quite different from the one recommended by electricity supply distributors.

There are, however, several ways of correcting the Power Factor:

a/ by changing the active power

- increase active energy consumption (space heaters, lighting, etc)
- use synchronous machines (cos φ = 1).

Fig. a

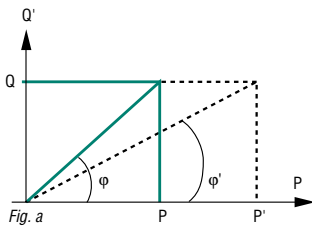

b/ by changing the reactive power

- provide capacitive reactive compensation for the generally inductive reactive drop in the installation (power lines and induction motors). Fig. b

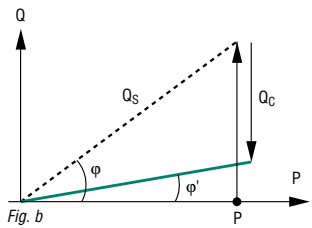

The need for Power Factor correction is not linked to faults in design or manufacture. Instead of the two procedures outlined above, it may be easier to use the chart opposite to calculate the compensating reactive power.

• Calculating the compensating reactive power

$$Q = \frac{Pu}{\eta} (tg\phi - tg\phi')$$

where Pu active output power

η motor efficiency

tg φ and tg φ' phase angle error before and after connection

• Connection of capacitors

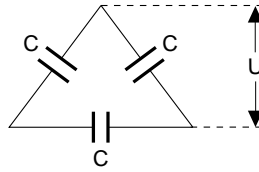

The capacitor values are given by the following formula (in three-phase):

$$Q = U^2 C \omega \cdot \sqrt{3}$$

U voltage of the mains with an angular velocity of the phases:

$$\omega (\omega = 2 \pi \cdot f)$$

IMPORTANT:

The use of capacitors on motor terminals can cause certain problems:

- in hypersynchronous braking, the motor operates as a self-excited generator and high peak voltages will occur across the mains connected terminals

- in the event of micro-cuts, reactive energy is released which will excite the motor. When the supply is restored, high transient voltages may occur.

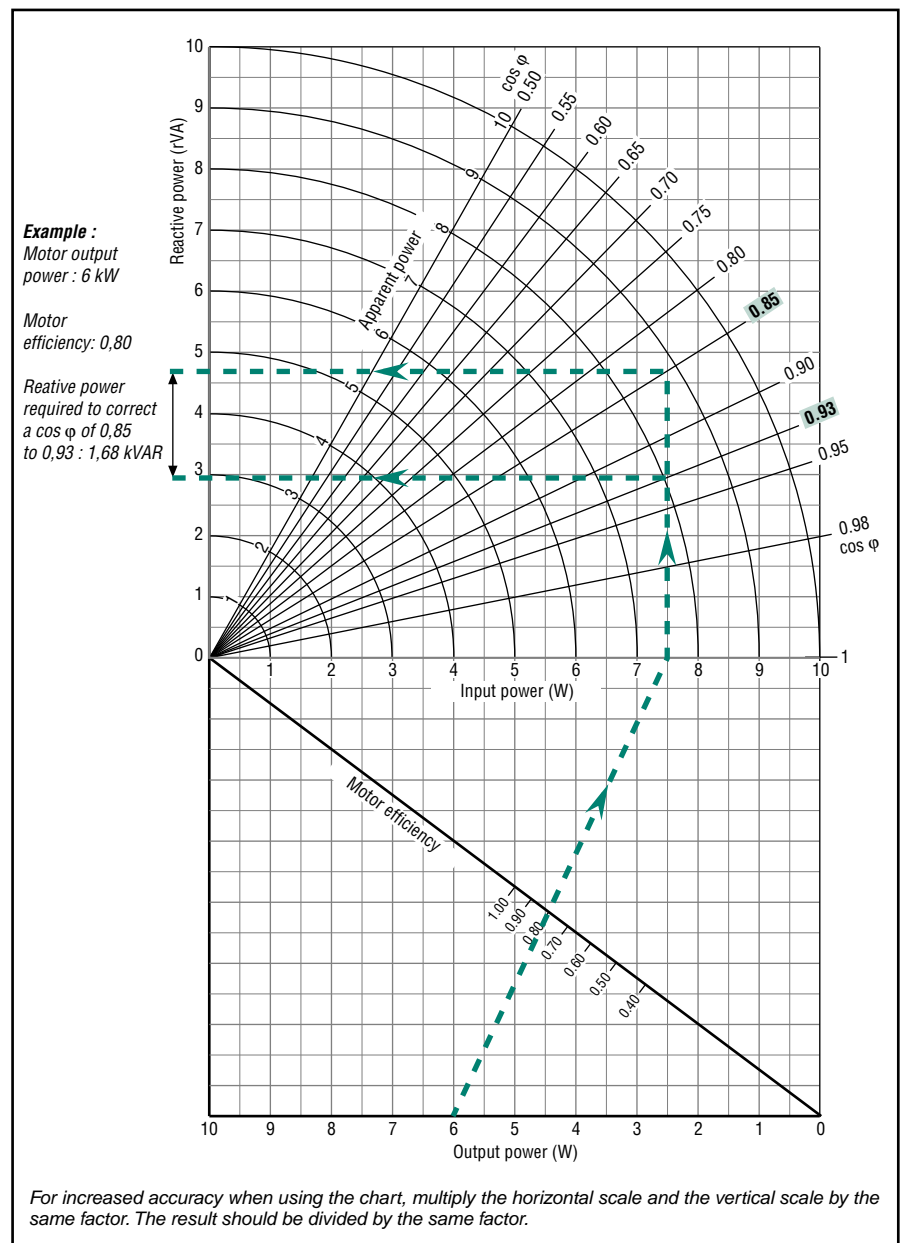

▲ Chart for finding the reactive power required for power factor improvement.

3-phase TEFV induction motors LS aluminium alloy frame Operation

D7 - Performance

D7.3 - MOTORS OPERATING IN PARALLEL

Motors connected to the same mechanical shaft

A mechanical shaft can be operated by two or more separate motors:

- If the motors are of the same type, the total power consumption on the line is equally distributed between the motors (to within the different slip variations).
- If the motors are of different types, the power is distributed according to the steady speed of the whole unit. So, a small motor with high slip, placed on the same line as a large motor with minimal slip, will run at more or less the same speed as the large motor and therefore only provide a small proportion of the rated power.



Motors coupled to independent shafts which must rotate at the same speed:

electrical shaft

To avoid deformation problems in large machines (gantry cranes, for example), separately sited mechanical shafts have to be synchronized to rotate at the same speed, whatever their loads.

We can then draw the follow diagram, called an electrical shaft:

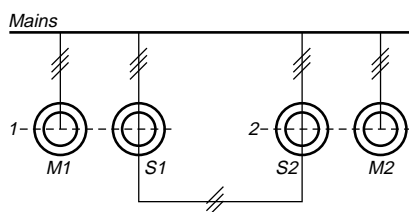

1 - 2 : mechanical shafts to be synchronized
M1 - M2: drive motors, normally cage induction motors, providing the average torque on each line.

S1 - S2: synchronizing slipping motors, coupled to the drive motors M1 and M2, whose rotor circuits are linked phase-to-phase. These motors have the dimensions required for providing the synchronization power defined in the application specification.

Note: There is a simplified version of this diagram, in which motors M1 and M2 are absent and motors S1 and S2 carry out both functions. In this case both rotors output into a single rheostat for minimum slip operation, which will enable any desynchronization (out-of-step) to be detected and the necessary speed compensation to be made.

For a given power, machine dimensions will have to be large enough to be able to supply sufficient motor and synchronization torque, and minimize losses due to rotor slip.

Motors in parallel on the same supply controlled by a single switch

Example: drying tunnel with several fans.

As manufacturing inaccuracies in the windings can occur, it is best to check the order of the motor and line phases before starting, and not to use motors with different internal connections so as to avoid circulating currents which might destroy complete installations.

All equipotential neutral connections must be excluded.

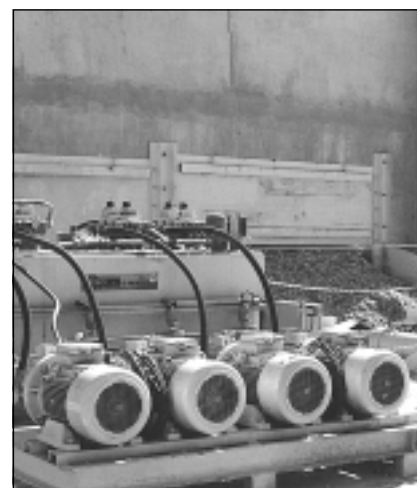

3-phase TEFV induction motors LS aluminium alloy frame Operation

D8 - Starting methods for cage induction motors

The two essential parameters for starting cage induction motors are:

- starting torque
- starting current

These two parameters and the resistive torque determine the starting time.

These three characteristics arise from the construction of cage induction motors. Depending on the driven load, it may be necessary to adjust these values to avoid torque impulse on the load or current surges in the supply. There are essentially five different types of supply, which are:

- D.O.L. starting
- star/delta starting
- soft starting with auto-transformer
- soft starting with resistors
- electronic starting

The tables on the next few pages give the electrical outline diagrams, the effect on the characteristic curves, and a comparison of the respective advantages of each mode.

D8.1 - MOTORS WITH ASSOCIATED ELECTRONICS

"Electronic" starting modes control the voltage at the motor terminals throughout the entire starting phase, giving very gradual smooth starting.

• "Unistart" electronic soft starter

This electronic starter enables three-phase induction motors to be started smoothly by controlling their acceleration.

Characteristics:

- $P < 2.2 \text{ kW}$ 380V-415V 50/60 Hz
- $P < 1.5 \text{ kW}$ 230V 50/60 Hz
- Ramp from 0.5 to 10 s
- Starting torque adjustable from 0 to 100%.



UNISTART

• "Digistart" electronic soft starter

- 10 models from 9 to 500 kW
- Supply: 220 to 690 V - 50/60 Hz

- Advantages:

- Protects both itself and the motor over the whole power range.
- Can be used on all motors without derating
- Fault signalling
- Simple digital programming
- Keypad or remote control



DIGISTART

• Hyper control

Hyper Control is an electronic system which is placed between the multi-speed motor and the low-speed power supply contactor, and is used to manage torque when changing from one speed to another.

6 power ratings

RATINGS	HC.1.22.400	HC.3.22.400	HC.4.8.9.400
Low speed motor power	0.06 to 3.9 kW		
Three-phase mains supply voltage	400 V +10% -10%		

RATINGS	HC.1.22.230	HC.3.22.230	HC.4.8.9.230
Low speed motor power	0.035 to 2.25 kW		
Three-phase mains supply voltage	230 V +10% -10%		

Mains frequency	50 / 60 Hz $\pm 5\%$
Protection	IP 20
Housing in composite material	

D8.2 - VARIABLE SPEED MOTOR

• These motors (VARMECA type) are designed and developed with built-in electronics.

Characteristics:

- $0.75 < P \leq 7.5 \text{ kW}^*$
- 50/60 Hz
- $360 < \text{speed} < 2400 \text{ min}^{-1}$
- for 4-pole motors
- $\cos \varphi = 1$
- Constant torque

* other power ranges on request

• Starting on variable speed drive

One of the advantages of variable speed drives is that loads can be started without a current surge on the mains supply, since starting is always performed with no voltage or frequency at the motor terminals.



VARMECA

3-phase TEFV induction motors LS aluminium alloy frame Operation

D8 - Starting methods for cage induction motors

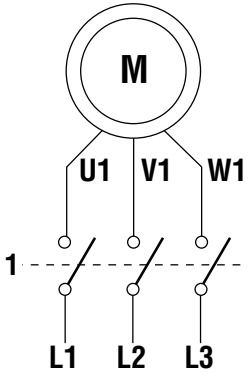
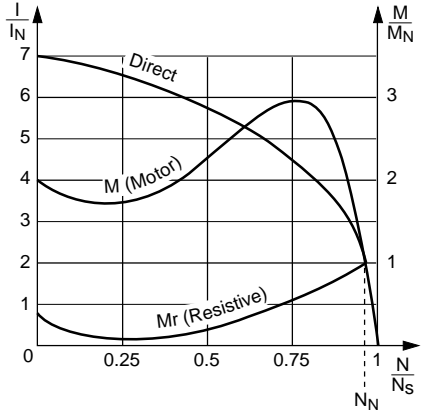
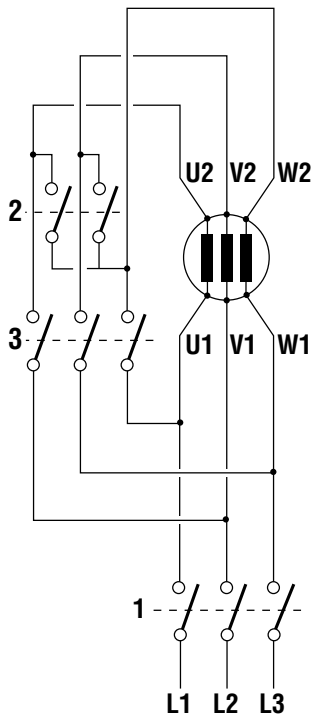
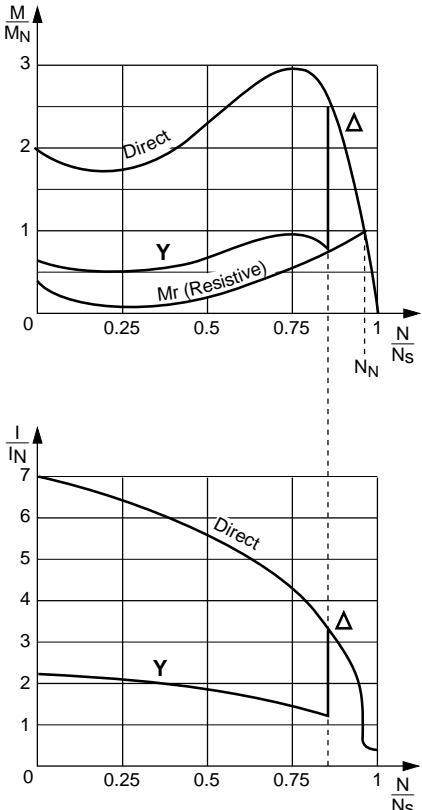
Mode	Outline diagram	Characteristic curves	Number of steps	Starting torque	Starting current	Advantages
D.O.L.			1	M_D	I_D	<ul style="list-style-type: none"> Simple equipment High torque Minimum starting time
Star Delta			2	$M_D / 3$	$I_D / 3$	<ul style="list-style-type: none"> Current requirement cut by two-thirds Simple equipment 3 contactors including one 2-pole



3-phase TEFV induction motors LS aluminium alloy frame Operation

D8 - Starting methods for cage induction motors

Mode	Outline diagram	Characteristic curves	Number of steps	Starting torque	Starting current	Advantages
Soft start with auto transformer			$n \geq 3$	$K^2 \cdot M_D$	$K^2 \cdot I_D$	<ul style="list-style-type: none"> Choice of torque level Reduction of current proportional to that of the torque Current is not cut off
Soft start with resistors			n	$K^2 \cdot M_D$	$K \cdot I_D$	<ul style="list-style-type: none"> Choice of torque or current Current is not cut off Fairly inexpensive (1 contactor per position)

3-phase TEFV induction motors LS aluminium alloy frame Operation

D8 - Starting methods for cage induction motors

Mode	Outline diagram	Characteristic curves	Number of steps	Starting torque	Starting current	Advantages
DIGISTART				$K^2 M_D$	$K I_D$	<ul style="list-style-type: none"> Adjustable on site Choice of torque and of current Current is not cut off Smooth starting Less space required No maintenance Higher number of starts Digital integrated motor and machine protection Serial link



3-phase TEFV induction motors LS aluminium alloy frame Operation

D9 - Braking methods

General information

The braking torque is equal to the torque produced by the motor increased by the resistive torque of the driven machine.

$$C_f = C_m + C_r$$

C_f = braking torque

C_m = motor torque

C_r = resistive torque

Braking time, i.e. the time required for an induction motor to change from speed N to stop, is calculated by the formula:

$$T_f = \frac{\pi \cdot J \cdot N}{30 \cdot C_f(av)}$$

T_f (in s) = braking time

J (in kgm^2) = moment of inertia

N (in min^{-1}) = speed of rotation

$C_f(av)$ (in N.m) = average braking torque during the time period

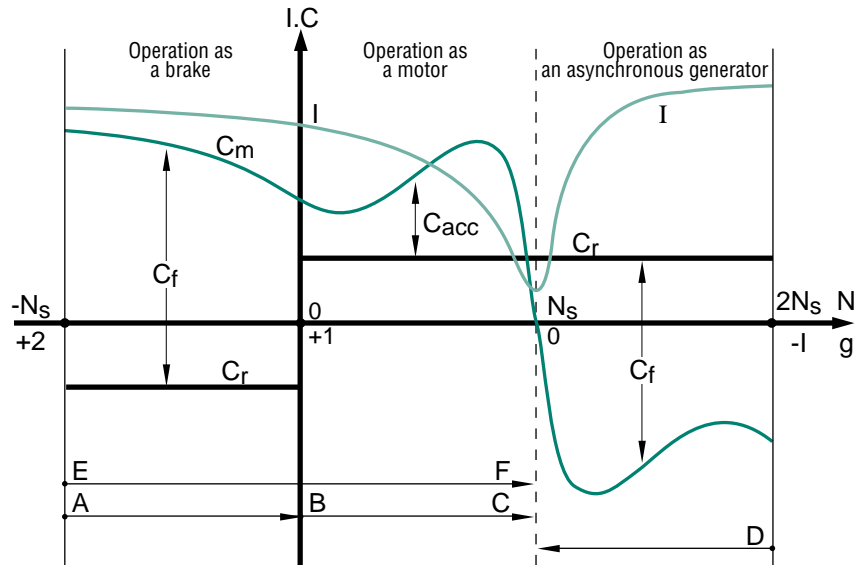

Curves $I = f(N)$, $C_m = f(N)$, $C_r = f(N)$, in the motor starting and braking zones.

I = current absorbed

C = torque value

C_f = braking torque

C_r = resistive torque

C_m = motor torque

N = speed of rotation

g = slip

N_s = synchronous speed

AB = reverse-current braking

BC = starting, acceleration

DC = braking as asynchronous generator

EF = reverse

Reverse-current braking

This method of braking is obtained by reversing two of the phases.

In general, an isolator disconnects the motor from the supply at the time the speed changes to $N=0$.

In cage induction motors, the average braking torque is generally greater than the starting torque.

Braking torque varies in different types of machine, as it depends on the rotor cage construction.

This method of braking involves a large amount of absorbed current, more or less constant and slightly higher than the starting current.

Thermal stresses during braking are three times higher than during acceleration.

Accurate calculations are required for repetitive braking.

Note: The direction of rotation of a motor is changed by reverse-current braking and restarting.

Thermically, one reversal is the equivalent of 4 starts. Care must therefore be taken when choosing a machine.

D.C. injection braking

Operating stability can be a problem when reverse-current braking is used, due to the flattening out of the braking torque curve in the speed interval $(0, -N_s)$.

There is no such problem with D.C. injection braking: this can be used on both cage induction and slipring motors.

With this braking method, the induction motor is connected to the mains and braking occurs when the A.C. voltage is cut off and D.C. voltage is applied to the stator.

There are four different ways of connecting the windings up to direct current.

The D.C. applied to the stator is usually supplied by a rectifier plugged into the mains.

Thermal stresses are approximately three times lower than for reverse-current braking.

The shape of the braking torque curve in the speed interval $(0, -N_s)$ is similar to that of the curve $C_m = f(N)$ and is obtained by changing the abscissa variable to $N_f = N_s - N$.

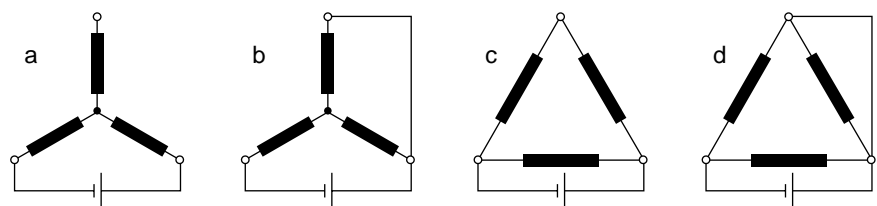

▲ Motor winding connections for direct current

3-phase TEFV induction motors LS aluminium alloy frame Operation

D9 - Braking methods

The braking current is calculated using the formula:

$$I_f = k1_i \times I_d \sqrt{\frac{C_f - C_{fe}}{k_2 \cdot C_d}}$$

The values of k1 for each of the four connections are:

$$k1_a = 1.225 \quad k1_c = 2.12$$

$$k1_b = 1.41 \quad k1_d = 2.45$$

The braking torque can be found by the formula:

$$C_f = \frac{\pi \cdot J \cdot N}{30 \cdot T_f}$$

In the formulae above:

I_f (in A) = braking current

I_d (in A) = starting current in the phase
= $\frac{1}{\sqrt{3}}$ I_d given in catalogue
(for Δ connection)

C_f (in N.m) = average braking torque in the interval (N_s , N)

C_{fe} (in N.m) = external braking torque

C_d (in N.m) = starting torque

J (en kgm^2) = total moment of inertia on the drive shaft

N (in min^{-1}) = speed of rotation

T_f (in s) = braking time

$k1_i$ = numerical factors for connections a, b, c and d (see diagram)

k2 = numerical factors taking into account the average braking torque (k2 = 1.7)

The direct current to be applied to the windings is calculated by:

$$U_f = k3_i \cdot k4 \cdot I_f \cdot R_1$$

k3 values for the four diagrams are as follows:

$$k3_a = 2$$

$$k3_b = 1.5$$

$$k3_c = 0.66$$

$$k3_d = 0.5$$

U_f (in V) = voltage for braking

I_f (in A) = direct current for braking

R_1 (en Ω) = stator phase resistance at 20° C

$k3_i$ = numerical factors for connections a, b, c and d (see diagrams)

k4 = numerical factor taking into account the motor temperature rise of the motor (k4 = 1.3)

Mechanical braking

Electromechanical brakes (D.C. or A.C field excitation) can be fitted at the rear of the motor.

For further details, see our "Brake motors" catalogue.

Regenerative braking

This is the braking method de applied to multi-speed motors when changing down to lower speeds. This procedure cannot be used to stop the motor.

Thermal stresses are approximately equal to those occurring when motors with Dahlander connections are started at the lower rated speed (speed ratio 1 : 2).

With the motor at the lower speed, working as a generator, it develops very high braking torque in the speed interval ($2N_s$, N_s).

The maximum braking torque is slightly higher than the starting torque of the motor at the lower speed.

Deceleration brakes

For safety reasons, deceleration brakes are fitted at the rear of motors used on hazardous machines (for example, where cutting tools may come into contact with the operator).

The range of brakes is determined by the braking torques:

2.5 - 4 - 8 - 16 - 32 - 60 Nm

The appropriate brake is selected in the factory according to the number of poles of the motor, the driven inertia, the number of brakings per hour and the required braking time.



3-phase TEFV induction motors LS aluminium alloy frame Operation

D10 - Operation as an asynchronous generator

D10.1 - GENERAL

The motor operates as an asynchronous generator each time the load becomes a driving load and the rotor speed exceeds the synchronous speed (N_s).

This can be induced either voluntarily, as in the case of electric power stations (water or wind power, etc) or involuntarily, caused by factors linked to the application (downward movement of crane hooks or blocks, inclined conveyors, etc).

D10.2 - OPERATING CHARACTERISTICS

The diagram opposite shows the various operations of an asynchronous machine in relation to its slip (g) or its speed (N).

Example: let us consider an induction motor of 45 kW, 4 poles, 50 Hz at 400V. As a rough estimate, its characteristics as an asynchronous generator can be deduced from its rated characteristics as a motor, by applying the rules of symmetry.

If more precise values are required, the manufacturer should be consulted.

In practice, it can be checked that the same machine, operating as a motor and as a generator with the same slip, has approximately the same losses in both cases, and therefore virtually the same efficiency. It can be deduced from this that the rated electrical power supplied by the asynchronous generator will be virtually the same as the motor output power.

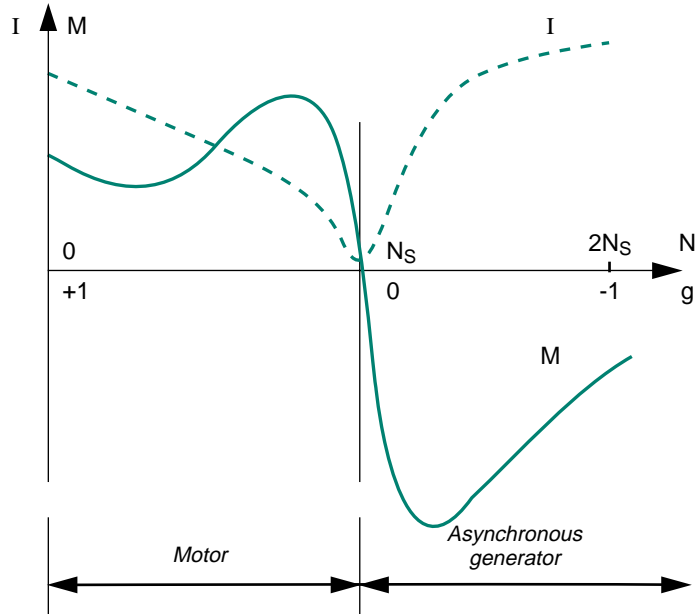

Characteristics	Motor	GA
Synchronous speed.....(min^{-1})	1500	1500
Rated speed(min^{-1})	1465	1535
Rated torque.....(m.N)	+ 287	- 287
Rated current at 400V(A)	87 A (absorbed)	87 A (supplied)

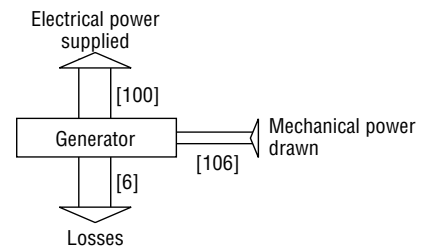
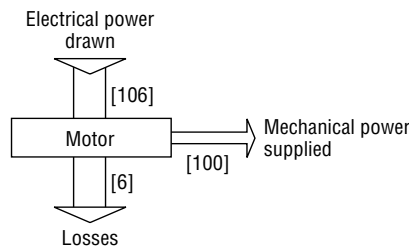

3-phase TEFV induction motors LS aluminium alloy frame Operation

D10 - Operation as an asynchronous generator



D10.3 - CONNECTION TO A POWERFUL MAINS SUPPLY

It is assumed that the machine stator is connected to a powerful electrical mains supply (usually the national grid), ie. a mains supply provided by a generator which regulates the power to at least twice that of the asynchronous generator.

Under these conditions, the mains supply imposes its own voltage and frequency on the asynchronous generator. Furthermore, it supplies it automatically with the reactive energy necessary for all its operating conditions.

D10.3.1 - Connection - Disconnection

Before connecting the asynchronous generator to the mains supply, it is necessary to ensure that the direction of phase rotation of the asynchronous generator and the mains supply are in the same order.

- To connect an asynchronous generator to the mains supply, it should be accelerated gradually until it reaches its synchronous speed N_s . At this speed, the machine torque is zero and the current is minimal.

This is an important advantage of asynchronous generators: as the rotor is not polarised until the stator is powered up, it is not necessary to synchronise the mains supply and the machine when they are connected.

However, there is a phenomenon affecting the connection of asynchronous generators which, in some cases, can be a nuisance: the rotor of the asynchronous generator, although not energised, still has some residual magnetism.

On connection, when the magnetic flux created by the mains supply and that caused by the residual magnetism of the rotor are not in phase, the stator experiences a very brief current peak (one or two half-waves), combined with an instantaneous overtorque of the same duration.

It is advisable to use connecting stator resistances to limit this phenomenon.

- Disconnecting the asynchronous generator from the mains supply does not pose any particular problem.

As soon as the machine is disconnected, it becomes electrically inert since it is no longer energised by the mains supply. It no longer brakes the driving machine, which should therefore be stopped to avoid reaching overspeed.

D10.3.1.1 - Reactive power compensation

To limit the current in the lines and the transformer, the asynchronous generator can be compensated by restoring the power factor of the installation to the unit, using a bank of capacitors.

In this case, the capacitors are only inserted at the terminals of the asynchronous generator once it has been connected, to avoid self-energisation of the machine due to the residual magnetism during speed pick-up. For a 3-phase low voltage asynchronous generator, 3-phase or single-phase capacitors in delta connection are used.

D10.3.1.2 - Electrical protection and safety

There are two protection and safety categories:

- those which relate to the mains
- those which relate to the set and its generator

The major mains protection devices monitor:

- maximum-minimum voltage
- maximum-minimum frequency

- minimum power or energy feedback (operating as a motor)

- generator connection fault

The protection devices for the set are:

- stop on detection of racing start
- lubrication faults

- thermal magnetic protection of the generator, usually with probes in the winding.

D10.4 - POWER SUPPLY FOR AN ISOLATED NETWORK

This concerns the supply of a consuming network which does not have another generator of sufficient power to impose its voltage and frequency on the asynchronous generator.

D10.4.1 - Reactive power compensation

In the most common case, reactive energy must be supplied:

- to the asynchronous generator
- to the user loads which consume it

To supply both of these consumption types with reactive energy, use a reactive energy source of suitable power connected in parallel on the circuit. This is usually a bank of capacitors with one or more stages which may be fixed, manually adjusted (using notches) or automatically adjusted. Synchronous capacitors are now rarely used.

Example: in an isolated network with power consumption of 50 kW where $\cos \varphi = 0.9$ (and $\tan \varphi = 0.49$), supplied by an asynchronous generator with $\cos \varphi$ of 0.8 at 50 kW (and $\tan \varphi = 0.75$), it is necessary to use a bank of capacitors which supplies:

$$(50 \times 0.49) + (50 \times 0.75) = 62 \text{ kvar}$$

3-phase TEFV induction motors LS aluminium alloy frame Operation

D10 - Operation as an asynchronous generator



D10.4.2 - Characteristic curves

At rated frequency, an asynchronous generator supplies a voltage which depends on the active power supplied and the value of the energisation capacitors.

For each asynchronous generator, it is possible to plot a network of curves such as those shown below.

In conclusion, to maintain a constant voltage, the reactive power must be adapted to the active power required.

Adjusting the load and the capacitors does not present any special difficulties. The table below shows how these parameters should be modified.

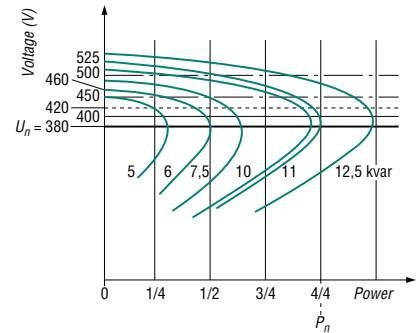

Example of a 13 kW and 6-pole machine

Direction of adjustment for load and capacitors

Problem		Action
Frequency	Voltage	
Too high	Too high	Increase the active load or reduce the speed or mechanical power
Too high	Too low	Increase the capacitor bank capacity
Too low	Too high	Decrease the capacitor bank capacity
Too low	Too low	Reduce the active load or increase the speed

D10.4.3 - Regulation

When the power consumed by the user or the power supplied by the driving machine vary but the frequency and voltage are to be maintained within narrow limits, a regulation device must be provided. This device is designed to maintain the correct electrical characteristics by adjusting one or more parameters:

- active power supplied (driving machine)
- active power consumed (loads on the circuit in use)
- reactive power supplied (usually capacitors).

D10.4.4 - Control and protection

The installation comprises an electrical measuring, control and protection enclosure.

The only special devices are:

- time delay on connection of the load circuit to avoid de-energisation of the machine on starting
- control of the energisation capacitors, manually or automatically as required

The rest of the electrical equipment is completely standard.

D10.5 - PERFORMANCE OF MOTORS USED AS AG

- Preference should be given to 4 - 6 or 8 pole versions for power ratings above 5.5 kW depending on the speeds of the driven machines.
- For small generators ($P \leq 4$ kW), the most common application uses 2 poles.
- For standard motors, the no-load voltages of asynchronous generators are very high and the voltage drop for the rated power is around 15% (power ratings below the rated power should not be used).
- Remember that asynchronous generators consume the reactive power required for their energisation and supply active power to the mains (isolated or non-isolated) and that the reactive power of the loads should be compensated.

3-phase TEFV induction motors LS aluminium alloy frame Electrical characteristics

PAGES

E1 - Selection data: single speed

2 poles - 3000 min ⁻¹	88 - 89
4 poles - 1500 min ⁻¹	90 - 91
6 poles - 1000 min ⁻¹	92 - 93
8 poles - 750 min ⁻¹	94 - 95

E2 - Selection data: two-speed

Centrifugal applications

2 / 4 poles - 3000 / 1500 min ⁻¹	96
4 / 6 poles - 1500 / 1000 min ⁻¹ (2 separate windings)	97
4 / 6 poles - 1500 / 1000 min ⁻¹ (1 PAM winding)	98
4 / 8 poles - 1500 / 750 min ⁻¹	99
6 / 12 poles - 1000 / 500 min ⁻¹	100

General table of two-speed motors

Centrifugal applications	101
General applications	102

For dimensions, see section **F**
page 103

3-phase TEFV induction motors LS aluminium alloy frame Electrical characteristics

E1 - Selection data: Single-speed

2
poles
3000 min⁻¹

IP 55 - S1
Cl. F - ΔT 80 K



MAINS SUPPLY Δ 230 / Y 400 V or Δ 400 V

50 Hz

Type	Rated power at 50 Hz	Rated speed	Rated torque	Rated current	Power factor			Efficiency			Starting current/ Rated current	Starting torque/ Rated torque	Max. torque/ Rated torque	Rated apparent power	Torque* curve	Moment of inertia	Weight
	P_N kW	N_N min ⁻¹	C_N N.m	$I_N (400V)$ A	50 %	$\cos \varphi$ 75 %	100 %	50 %	η 75 %	100 %	I_D / I_N	M_D / M_N	M_M / M_N	kVA_N	N°	J kg.m ²	IM B3 kg
LS 56 L	0.09	2860	0.3	0.44	0.40	0.45	0.55	37	45	54	4.9	5.5	5.6	0.30	1	0.00015	3.8
LS 56 L	0.12	2820	0.4	0.50	0.45	0.55	0.60	45	54	58	4.6	4.1	4.2	0.34	1	0.00015	3.8
LS 63 M	0.18	2790	0.6	0.52	0.55	0.65	0.75	59	66	67	5	3.4	3	0.36	1	0.00019	4.8
LS 63 M	0.25	2800	0.8	0.71	0.55	0.65	0.75	59	67	68	5.4	3.4	3.1	0.49	1	0.00025	6
LS 71 L	0.37	2800	1.3	0.98	0.60	0.70	0.80	63	67	68	5.2	3.2	3.8	0.68	1	0.00035	6.4
LS 71 L	0.55	2800	1.9	1.32	0.55	0.70	0.80	71	75	75	6	3.2	3.1	0.92	1	0.00045	7.3
LS 71 L	0.75	2780	2.5	1.70	0.65	0.75	0.85	73	75	75	6	3.4	3	1.18	1	0.00060	8.3
LS 80 L	0.75	2840	2.5	1.64	0.68	0.80	0.87	74	76.5	76	5.9	2.4	2.2	1.13	1	0.00070	8.2
LS 80 L	1.1	2837	3.7	2.4	0.65	0.77	0.84	76.6	78.5	78	5.8	2.7	2.4	1.7	6	0.00090	9.7
LS 80 L	1.5	2859	5	3.2	0.62	0.76	0.83	78	80.4	80.3	7	3.2	2.8	2.2	5	0.0011	11.3
LS 90 S	1.5	2870	5	3.4	0.58	0.72	0.81	75.1	78.9	79.6	8	3.9	4	2.3	5	0.0014	12
LS 90 L	1.8	2865	6	3.6	0.69	0.80	0.86	81.7	83.4	83.1	8	3.6	3.6	2.5	5	0.0017	14
LS 90 L	2.2	2862	7.4	4.3	0.73	0.83	0.88	82.9	84	83.6	7.7	3.7	3.3	3	5	0.0021	16
LS 100 L	3	2868	10	6.3	0.59	0.73	0.81	80.8	83.8	83.9	7.5	3.8	3.9	4.3	5	0.0022	20
LS 112 M	4	2877	13.5	7.9	0.65	0.78	0.85	84.4	86.1	86	7.8	2.9	2.9	5.5	5	0.0029	24.4
LS 112 MG	5.5	2916	18.1	10.5	0.71	0.81	0.88	85.6	87.2	86.6	9	3.1	3.5	7.2	5	0.0076	33
LS 132 S	5.5	2916	18.1	10.5	0.71	0.81	0.88	85.6	87.2	86.6	9	3.1	3.5	7.2	5	0.0076	34.4
LS 132 S	7.5	2905	24.5	14.7	0.63	0.78	0.85	84.5	86.4	86.5	8.7	3.4	3.6	10.2	5	0.0088	39
LS 132 M	9	2910	29.6	17.3	0.71	0.80	0.85	87.5	88.4	88.1	8.6	2.5	3.5	12	5	0.016	49
LS 132 M	11	2944	36	20.7	0.69	0.81	0.86	87.7	89.4	89.4	7.5	2.7	3.4	14.3	5	0.018	54
LS 160 MP	11	2944	36	20.7	0.69	0.81	0.86	87.7	89.4	89.4	7.5	2.7	3.4	14.3	5	0.019	62
LS 160 MP	15	2935	48.8	28.4	0.71	0.79	0.85	85.1	90.1	90	8.1	3	3.5	19.7	5	0.023	72
LS 160 L	18.5	2934	60.2	33.7	0.75	0.83	0.87	90.4	91.2	91	8	3	3.3	23.4	4	0.044	88
LS 180 MT	22	2938	71.5	39.9	0.76	0.84	0.87	91.2	91.8	91.5	8.1	3.1	3.1	27.6	4	0.052	99
LS 200 LT	30	2946	97.2	52.1	0.82	0.87	0.9	92.1	92.7	92.4	8.6	2.7	3.4	36.1	4	0.089	154
LS 200 L	37	2950	120	64.6	0.82	0.87	0.89	92.2	93	92.9	7.4	2.6	3	44.8	4	0.120	180
LS 225 MT	45	2950	146	77.4	0.82	0.87	0.9	93.1	93.4	93.3	7.5	2.8	3.1	53.6	4	0.140	200
LS 250 MZ	55	2956	178	95.2	0.8	0.86	0.89	93.1	93.7	93.7	8.3	3.1	3.4	66	4	0.173	235
LS 280 SC	75	2968	241	127	0.82	0.87	0.9	93.8	94.4	94.4	8.5	2.6	3.4	88.3	4	0.39	330
LS 280 MC	90	2968	290	152	0.83	0.88	0.9	94.1	94.7	94.7	8.4	2.6	3.3	105.6	4	0.47	375
LS 315 SP	110	2976	353	190	0.8	0.86	0.88	93.2	94.3	94.8	7.8	2.8	2.9	131.9	4	1.43	645
LS 315 MP	132	2976	424	225	0.82	0.87	0.89	93.4	94.6	95	7.6	2.8	2.9	156.1	4	1.67	715
LS 315 MR	160	2976	513	270	0.84	0.88	0.9	93.6	94.8	95.1	7.6	2.9	3.1	186.9	4	1.97	820
LS 315 MR •	200	2982	640	349	0.82	0.86	0.87	94.3	94.9	95	9.3	3.8	3.9	242	4	1.97	845

• Class F temperature rise

* Torque curve

Noise level

section D4.4 - page 61

section D6.1 - page 71

3-phase TEFV induction motors LS aluminium alloy frame Electrical characteristics

E1 - Selection data: Single-speed

2
poles
3600 min⁻¹

Type	MAINS SUPPLY 380 V 50 Hz					MAINS SUPPLY 415V 50Hz					MAINS SUPPLY 460 V 60 Hz can be used from 440V to 480V				
	Rated power at 50 Hz	Rated speed	Rated current	Power factor	Efficiency	Rated speed	Rated current	Power factor	Efficiency	Rated Power at 60 Hz	Rated speed	Rated current	Power factor	Efficiency	
	P_N kW	N_N min ⁻¹	I_N A	$\cos \varphi$	η %	N_N min ⁻¹	I_N A	$\cos \varphi$	η %	P_N kW	N_N min ⁻¹	I_N A	$\cos \varphi$	η %	
LS 56 L	0.09	2850	0.42	0.60	56	2870	0.49	0.50	51	0.11	3450	0.47	0.50	59	
LS 56 L	0.12	2800	0.47	0.65	60	2830	0.50	0.60	56	0.15	3400	0.47	0.65	61	
LS 63 M	0.18	2750	0.53	0.80	65	2800	0.55	0.70	65	0.22	3400	0.53	0.75	69	
LS 63 M	0.25	2750	0.73	0.80	65	2810	0.74	0.70	67	0.30	3420	0.65	0.80	72	
LS 71 L	0.37	2780	0.97	0.85	68	2820	0.95	0.80	68	0.44	3380	0.93	0.85	70	
LS 71 L	0.55	2750	1.33	0.85	74	2810	1.36	0.75	75	0.66	3380	1.34	0.80	77	
LS 71 L	0.75	2730	1.84	0.85	73	2790	1.74	0.80	75	0.90	3360	1.73	0.85	77	
LS 80 L	0.75	2810	1.68	0.89	76	2850	1.59	0.85	77	0.90	3410	1.65	0.89	77	
LS 80 L	1.1	2806	2.5	0.87	77.3	2855	2.5	0.80	77.9	1.3	3422	2.4	0.86	79.7	
LS 80 L	1.5	2839	3.3	0.87	80.1	2871	3.3	0.80	79.8	1.8	3450	3.2	0.85	82	
LS 90 S	1.5	2852	3.3	0.86	80.4	2881	3.5	0.76	78.6	1.8	3461	3.3	0.84	81.4	
LS 90 L	1.8	2840	3.7	0.89	82.6	2878	3.6	0.83	83	2.2	3452	3.7	0.88	84	
LS 90 L	2.2	2840	4.5	0.90	82.8	2877	4.3	0.86	83.7	2.6	3449	4.4	0.89	84.1	
LS 100 L	3	2849	6.3	0.87	83.5	2880	6.7	0.76	82.5	3.6	3458	6.3	0.85	84.5	
LS 112 M	4	2859	8	0.89	85.8	2890	8	0.81	85.8	4.8	3467	7.9	0.88	86.8	
LS 112 MG	5.5	2902	10.7	0.91	86.5	2921	10.4	0.85	86.4	6.6	3505	10.6	0.9	87.1	
LS 132 S	5.5	2902	10.7	0.91	86.5	2921	10.4	0.85	86.4	6.6	3505	10.6	0.9	87.1	
LS 132 S	7.5	2894	14.6	0.90	86.8	2914	15.2	0.80	85.8	9	3497	14.5	0.89	87.8	
LS 132 M	9	2895	17.6	0.88	87.7	2918	17.4	0.82	87.9	11	3502	17.8	0.87	88.8	
LS 132 M	11	2933	21	0.89	89.3	2948	20.9	0.82	89.2	13.2	3536	20.8	0.88	90	
LS 160 MP	11	2933	21	0.89	89.3	2948	20.9	0.82	89.2	13.2	3536	20.8	0.88	90	
LS 160 MP	15	2928	28.8	0.88	89.8	2942	29.1	0.80	89.5	18	3530	28.6	0.87	91	
LS 160 L	18.5	2924	34.9	0.89	90.6	2940	33.2	0.85	91.1	21	3528	32.4	0.89	91.3	
LS 180 MT	22	2928	41.2	0.89	91.1	2944	39.3	0.85	91.6	25	3532	38.4	0.89	91.8	
LS 200 LT	30	2936	54.4	0.91	92	2950	50.6	0.89	92.6	34	3542	50.8	0.91	92.4	
LS 200 L	37	2942	67.5	0.9	92.5	2954	62.9	0.88	93	42	3546	62.8	0.9	93.2	
LS 225 MT	45	2942	80.8	0.91	93	2954	75.3	0.89	93.4	52	3546	77.6	0.9	93.5	
LS 250 MZ	55	2948	99.4	0.9	93.4	2960	92.7	0.88	93.8	63	3552	93.7	0.9	93.8	
LS 280 SC	75	2962	133	0.91	94.2	2970	124	0.89	94.5	86	3564	126	0.91	94.1	
LS 280 MC	90	2962	159	0.91	94.5	2970	148	0.89	94.8	103	3564	151	0.91	94.3	
LS 315 SP	110	2974	198	0.89	94.7	2978	186	0.87	94.8	126	3576	188	0.89	94.3	
LS 315 MP	132	2974	235	0.9	94.9	2978	220	0.88	95	152	3576	224	0.9	94.5	
LS 315 MR	160	2974	281	0.91	95	2978	263	0.89	95.2	184	3576	271	0.9	94.8	
LS 315 MR •	200	2980	363	0.88	95	2983	354	0.83	94.8	230	3580	347	0.88	94.6	

• Class F temperature rise

Note: For mains supplies with different voltages, see section D2.2.4.

3-phase TEFV induction motors LS aluminium alloy frame Electrical characteristics

E1 - Selection data: Single-speed

4
poles
1500 min⁻¹

IP 55 - S1
Cl. F - ΔT 80 K



MAINS SUPPLY Δ 230 / Y 400 V or Δ 400 V

50 Hz

Type	Rated power at 50 Hz	Rated speed	Rated torque	Rated current	Power factor			Efficiency			Starting current/ Rated current	Starting torque/ Rated torque	Max. torque/ Rated torque	Apparent rated power	Torque* curve	Moment of inertia	Weight
	P_N kW	N_N min ⁻¹	C_N N.m	$I_N (400V)$ A	50 %	$\cos \phi$ 75 %	100 %	50 %	η 75 %	100 %	I_D / I_N	M_D / M_N	M_M / M_N	kVA_N	N°	J kg.m ²	IM B3 kg
LS 56 L	0.09	1400	0.6	0.39	0.42	0.52	0.60	42.8	49.6	55	3.2	2.8	2.8	0.27	2	0.00025	4
LS 63 M	0.12	1380	0.8	0.44	0.47	0.58	0.70	46.8	54	56	3.2	2.5	2.4	0.31	2	0.00035	4.8
LS 63 M	0.18	1390	1.2	0.64	0.44	0.55	0.65	51	58	62	3.7	2.7	2.7	0.45	2	0.00048	5
LS 71 L	0.25	1425	1.7	0.80	0.45	0.56	0.65	60	67	69	4.6	2.7	2.9	0.56	2	0.00068	6.4
LS 71 L	0.37	1420	2.5	1.06	0.47	0.59	0.70	66	72	72	4.9	2.4	2.8	0.73	2	0.00085	7.3
LS 71 L	0.55	1400	3.8	1.62	0.49	0.62	0.70	65	70	70	4.8	2.3	2.5	1.12	2	0.0011	8.3
LS 80 L	0.55	1410	3.8	1.42	0.55	0.68	0.76	62	69.3	73.4	4.5	2	2.3	1	7	0.0013	8.2
LS 80 L	0.75	1400	5.1	2.01	0.59	0.71	0.77	66	70	70	4.5	2	2.2	1.4	7	0.0018	9.3
LS 80 L	0.9	1425	6	2.44	0.54	0.67	0.73	70	73	73	5.8	3	3	1.6	6	0.0024	10.9
LS 90 S	1.1	1429	7.4	2.5	0.64	0.77	0.84	77.1	78.4	76.8	4.8	1.6	2	1.7	7	0.0026	11.5
LS 90 L	1.5	1428	10	3.4	0.60	0.74	0.82	77.5	79.4	78.5	5.3	1.8	2.3	2.3	7	0.0032	13.5
LS 90 L	1.8	1438	12	4	0.61	0.75	0.82	79	80.8	80.1	6	2.1	3.2	2.7	4	0.0037	15.2
LS 100 L	2.2	1436	14.7	4.8	0.59	0.73	0.81	79.8	81.5	81	5.9	2.1	2.5	3.4	7	0.0043	20
LS 100 L	3	1437	20.1	6.5	0.59	0.72	0.81	80.8	82.6	82.6	6	2.5	2.8	4.5	6	0.0055	22.5
LS 112 M	4	1438	26.8	8.3	0.57	0.76	0.83	83.4	84.2	84.2	7.1	2.5	3	5.7	6	0.0067	24.9
LS 132 S	5.5	1447	36.7	11.1	0.67	0.79	0.83	85.8	86.4	85.7	6.3	2.4	2.8	7.7	6	0.014	36.5
LS 132 M	7.5	1451	49.4	15.2	0.61	0.74	0.82	84.9	86.4	87	7	2.4	2.9	10.5	6	0.019	54.7
LS 132 M	9	1455	59.3	18.1	0.62	0.74	0.82	86.2	87.6	87.7	6.9	2.2	3.1	12.5	4	0.023	59.9
LS 160 MP	11	1454	72.2	21	0.67	0.79	0.86	87.4	88.6	88.4	7.7	2.3	3.2	14.5	1	0.030	70
LS 160 LR	15	1453	98	28.8	0.69	0.78	0.84	88.4	89.8	89.4	7.5	2.9	3.6	20	1	0.036	86
LS 180 MT	18.5	1456	121	35.2	0.67	0.79	0.84	90.3	90.8	90.3	7.6	2.7	3.2	24.4	1	0.085	100
LS 180 LR	22	1456	144	41.7	0.68	0.79	0.84	90.9	91.2	90.7	7.9	3	3.3	28.9	1	0.096	112
LS 200 LT	30	1460	196	56.3	0.69	0.8	0.84	91.5	92	91.5	6.6	2.9	2.9	39	2	0.151	165
LS 225 ST	37	1468	241	68.7	0.7	0.8	0.84	92.9	93.1	92.5	6.3	2.7	2.6	47.6	2	0.24	205
LS 225 MR	45	1468	293	83.3	0.7	0.8	0.84	93	93.3	92.8	6.3	2.7	2.6	57.7	2	0.29	235
LS 250 ME	55	1478	355	101	0.71	0.8	0.84	93.2	93.8	93.6	7	2.7	2.8	70	3	0.63	320
LS 280 SC	75	1478	485	137	0.71	0.8	0.84	93.8	94.4	94.2	7.2	2.8	2.9	94.8	3	0.83	380
LS 280 MD	90	1478	581	164	0.71	0.8	0.84	93.8	94.5	94.4	7.6	3	3	113.5	3	1.03	450
LS 315 SP	110	1484	708	197	0.74	0.82	0.85	93.9	94.7	94.8	7	2.7	2.7	136.5	3	2.32	670
LS 315 MP	132	1484	849	236	0.74	0.82	0.85	94.1	95	95	7.6	2.9	3	163.5	3	2.79	750
LS 315 MR	160	1484	1030	286	0.74	0.82	0.85	94.1	95	95	7.7	2.9	3	198.1	3	3.27	845
LS 315 MR •	200	1486	1285	359	0.69	0.79	0.84	95.1	95.8	95.8	8.1	3.1	3.4	248.5	3	3.27	860

• Class F temperature rise

* Torque curve

Noise level

section D4.4 - page 61

section D6.1 - page 71

3-phase TEFV induction motors LS aluminium alloy frame Electrical characteristics

E1 - Selection data: Single-speed

4
poles
1800 min⁻¹

Type	MAINS SUPPLY 380 V 50 Hz					MAINS SUPPLY 415V 50 Hz					MAINS SUPPLY 460V 60 Hz can be used from 440V to 480V				
	Rated power at 50 Hz	Rated speed	Rated current	Power factor	Efficiency	Rated speed	Rated current	Power factor	Efficiency	Rated power at 60 Hz	Rated speed	Rated current	Power factor	Efficiency	
	P_N kW	N_N min ⁻¹	I_N A	$\cos \varphi$	η %	N_N min ⁻¹	I_N A	$\cos \varphi$	η %	P_N kW	N_N min ⁻¹	I_N A	$\cos \varphi$	η %	
LS 56 L	0.09	1380	0.38	0.65	56	1410	0.40	0.60	52	0.11	1700	0.36	0.60	62	
LS 63 M	0.12	1365	0.47	0.70	56	1390	0.46	0.65	56	0.15	1680	0.46	0.70	59	
LS 63 M	0.18	1375	0.68	0.65	62	1400	0.68	0.60	61	0.22	1690	0.64	0.65	65	
LS 71 L	0.25	1425	0.78	0.70	70	1430	0.84	0.60	69	0.30	1720	0.76	0.70	71	
LS 71 L	0.37	1410	1.10	0.70	73	1430	1.10	0.65	72	0.44	1720	1.06	0.70	75	
LS 71 L	0.55	1385	1.59	0.75	70	1410	1.56	0.70	70	0.66	1700	1.51	0.75	73	
LS 80 L	0.55	1396	1.43	0.80	73	1415	1.41	0.74	72.7	0.66	1725	1.4	0.78	77.3	
LS 80 L	0.75	1380	2.06	0.80	69	1410	2.01	0.74	70	0.90	1700	2.01	0.77	73	
LS 80 L	0.9	1415	2.43	0.77	73	1435	2.48	0.70	72	1.1	1710	2.39	0.77	75	
LS 90 S	1.1	1416	2.5	0.87	75.5	1437	2.4	0.82	77.2	1.3	1726	2.4	0.85	78.9	
LS 90 L	1.5	1415	3.4	0.86	77.6	1436	3.4	0.79	78.4	1.8	1722	3.3	0.84	80.4	
LS 90 L	1.8	1427	4	0.85	79.4	1443	4	0.79	80.1	2.2	1733	4	0.84	81.9	
LS 100 L	2.2	1426	4.9	0.84	80.2	1442	4.9	0.78	80.6	2.7	1731	4.8	0.82	82.6	
LS 100 L	3	1427	6.6	0.84	81.7	1443	6.6	0.77	81.9	3.6	1731	6.5	0.83	83.7	
LS 112 M	4	1430	8.6	0.85	83	1448	8.2	0.81	83.6	4.8	1740	8.4	0.84	85.3	
LS 132 S	5.5	1438	11.5	0.87	84.3	1450	11.3	0.80	84.6	6.6	1748	11.1	0.83	86.2	
LS 132 M	7.5	1445	15.8	0.85	85	1455	15	0.82	85	9	1750	15.5	0.85	86	
LS 132 M	9	1440	18.5	0.86	86	1455	18.2	0.80	86	11	1750	18.9	0.84	87	
LS 160 MP	11	1446	21.5	0.89	87.8	1458	20.9	0.83	88.2	13.2	1754	20.8	0.85	89.2	
LS 160 LR	15	1446	29.8	0.87	88.3	1458	29.9	0.79	88.3	17	1762	29.4	0.82	89.5	
LS 180 MT	18.5	1450	35.9	0.87	90	1460	34.7	0.82	90.5	21	1754	33.6	0.86	91.1	
LS 180 LR	22	1450	43	0.86	90.4	1460	41.1	0.82	90.9	25	1754	39.9	0.86	91.5	
LS 200 LT	30	1454	58.2	0.86	91.1	1464	55.6	0.82	91.6	34	1758	54.5	0.85	92.1	
LS 225 ST	37	1462	71.8	0.85	92.1	1470	67.8	0.82	92.6	42	1764	66.7	0.85	93	
LS 225 MR	45	1462	87.1	0.85	92.3	1470	82.2	0.82	92.9	52	1764	82.4	0.85	93.2	
LS 250 ME	55	1476	105	0.85	93.2	1480	99.6	0.82	93.7	63	1778	99.3	0.85	93.7	
LS 280 SC	75	1476	143	0.85	93.9	1480	135	0.82	94.3	86	1778	135	0.85	94.3	
LS 280 MD	90	1476	171	0.85	94.1	1480	162	0.82	94.5	103	1778	161	0.85	94.5	
LS 315 SP	110	1482	205	0.86	94.6	1486	192	0.84	94.9	126	1784	196	0.85	94.9	
LS 315 MP	132	1482	246	0.86	94.9	1486	230	0.84	95.1	152	1784	233	0.86	95.1	
LS 315 MR	160	1482	298	0.86	94.9	1486	279	0.84	95.1	184	1784	282	0.86	95.1	
LS 315 MR •	200	1484	365	0.87	95.8	1487	354	0.82	95.8	230	1784	350	0.86	95.9	

• Class F temperature rise

Note: For mains supplies with different voltages, see section D2.2.4.

3-phase TEFV induction motors LS aluminium alloy frame Electrical characteristics

E1 - Selection data: Single-speed

6
poles
1000 min⁻¹

IP 55 - S1
Cl. F - ΔT 80 K

MAINS SUPPLY Δ 230 / Y 400 V or Δ 400 V

50 Hz

Type	Rated power at 50 Hz	Rated speed	Rated torque	Rated current	Power factor			Efficiency			Starting current/ Rated current	Starting torque/ Rated torque	Max. torque/ Rated torque	Rated apparent power	Torque* curve	Moment of inertia	Weight
	P_N kW	N_N min ⁻¹	C_N N.m	$I_N (400V)$ A	50 %	$\cos \varphi$ 75 %	100 %	50 %	η 75 %	100 %	I_D / I_N	M_D / M_N	M_M / M_N	kVA_N	N°	J kg.m ²	IM B3 kg
LS 63 M	0.09	860	0.9	0.46	0.63	0.70	0.80	26	32	35	2.1	1.8	1.8	0.32	3	0.0006	5.5
LS 71 L	0.12	920	1.3	0.64	0.40	0.48	0.55	36	45	49	2.9	2.5	2.6	0.45	3	0.0007	6.5
LS 71 L	0.18	895	1.8	0.81	0.43	0.53	0.62	43	50	52	2.7	1.9	2	0.56	3	0.0011	7.6
LS 71 L	0.25	840	2.6	1	0.48	0.59	0.70	47	52	50	2.5	1.7	1.7	0.71	3	0.0013	7.9
LS 80 L	0.25	955	2.5	0.85	0.48	0.64	0.67	56	63	63.1	3.9	1.6	1.8	0.59	8	0.0024	8.4
LS 80 L	0.37	950	3.7	1.1	0.57	0.67	0.72	59	61	66	4.3	1.7	2.2	0.76	8	0.0032	9.7
LS 80 L	0.55	950	5.5	1.8	0.47	0.60	0.64	55	63	68	4.9	2.1	2.6	1.2	7	0.0042	11
LS 90 S	0.75	930	7.7	2.1	0.54	0.66	0.77	60	65	68.5	4.2	2.4	2.6	1.4	7	0.0039	13.5
LS 90 L	1.1	915	11.5	3	0.55	0.67	0.76	66	70	70	4.7	2.4	2.5	2.1	6	0.0048	15.2
LS 100 L	1.5	905	15.8	4.2	0.52	0.62	0.74	65	69	69	4.5	2.5	2.7	2.9	6	0.0058	20
LS 112 M	2.2	905	23.2	5.8	0.53	0.66	0.76	68	72	72	5.6	2.8	2.7	4	6	0.0087	24.2
LS 132 S	3	957	30.3	6.8	0.59	0.71	0.78	75	78	81.1	6	2	2.6	4.7	7	0.018	38.3
LS 132 M	4	961	39.6	9.3	0.56	0.66	0.75	78	83	83.6	5.9	2.5	2.9	6.4	7	0.034	53.3
LS 132 M	5.5	960	54.2	13.3	0.52	0.65	0.71	80	83.5	84.1	5.5	2.5	2.8	9.2	6	0.039	59.4
LS 160 M	7.5	967	74.1	16.1	0.63	0.74	0.79	82.6	84.8	85.2	4.7	1.5	2.1	11.1	7	0.086	81
LS 160 L	11	967	109	23.3	0.64	0.75	0.79	85	86.5	86.3	4.6	1.6	2.1	16.1	7	0.116	105
LS 180 LR	15	968	148	31.9	0.61	0.71	0.78	86.1	87.3	87.1	5.4	1.8	2.6	22.1	7	0.139	110
LS 200 LT	18.5	970	182	37	0.65	0.76	0.81	88.1	89.3	89	6.4	2.4	2.8	25.7	7	0.236	160
LS 200 L	22	972	216	43.6	0.65	0.76	0.81	89	90.1	89.9	6	2	2.7	30.2	7	0.295	190
LS 225 MR	30	968	296	59.5	0.72	0.79	0.81	89.2	90.3	89.9	6	2.2	2.5	41.2	7	0.39	235
LS 250 ME	37	978	361	71.1	0.69	0.79	0.81	92.9	93.2	92.7	6.2	2.3	2.5	49.3	7	0.85	305
LS 280 SC	45	978	439	86.5	0.69	0.79	0.81	92.9	93.2	92.7	6.2	2.3	2.5	59.9	7	0.99	340
LS 280 MC	55	978	537	106	0.72	0.79	0.81	93.1	93.3	92.6	6	2.4	2.5	73.3	7	1.19	385
LS 315 SP	75	980	731	140	0.69	0.78	0.83	92.5	93.3	93.3	7.2	2.4	3	96.9	7	3.09	690
LS 315 MP	90	980	877	164	0.76	0.83	0.85	92.4	93.1	93.1	7.2	2.4	2.9	113.7	7	3.74	760
LS 315 MR	110	980	1072	200	0.76	0.83	0.85	93	93.5	93.5	7.2	2.4	2.9	138.4	7	4.36	850
LS 315 MR	132	986	1278	242	0.72	0.8	0.83	94.3	94.9	94.8	6.6	2.4	2.5	167.8	7	4.36	830

* Torque curve

Noise level

section D4.4 - page 61

section D6.1 - page 71

3-phase TEFV induction motors LS aluminium alloy frame Electrical characteristics

E1 - Selection data: Single-speed

6
poles
1200 min⁻¹

Type	MAINS SUPPLY 380 V 50 Hz					MAINS SUPPLY 415 50 Hz					MAINS SUPPLY 460V 60 Hz can be used from 440V to 480V				
	Rated power at 50 Hz	Rated speed	Rated current	Power factor	Efficiency	Rated speed	Rated current	Power factor	Efficiency	Rated power at 60 Hz	Rated speed	Rated current	Power factor	Efficiency	
	P_N kW	N_N min ⁻¹	I_N A	$\cos \varphi$	η %	N_N min ⁻¹	I_N A	$\cos \varphi$	η %	P_N kW	N_N min ⁻¹	I_N A	$\cos \varphi$	η %	
LS 63 M	0.09	840	0.47	0.84	35	880	0.46	0.80	34	0.11	1060	0.44	0.70	45	
LS 71 L	0.12	910	0.62	0.59	50	925	0.67	0.53	47	0.14	1120	0.60	0.55	53	
LS 71 L	0.18	850	0.82	0.67	50	895	0.82	0.60	51	0.22	1100	0.79	0.60	58	
LS 71 L	0.25	830	1.09	0.71	49	890	1.05	0.64	52	0.30	1080	1	0.66	57	
LS 80 L	0.25	930	0.8	0.74	64	960	0.85	0.65	63	0.30	1145	0.79	0.70	68	
LS 80 L	0.37	940	1.11	0.77	67	955	1.1	0.70	66	0.45	1145	1.10	0.74	70	
LS 80 L	0.55	930	1.8	0.74	64	960	1.9	0.65	63	0.66	1145	1.7	0.70	68	
LS 90 S	0.75	915	2	0.81	69	935	2.1	0.73	67	0.90	1125	2.1	0.76	71	
LS 90 L	1.1	895	3	0.80	70	920	3.1	0.72	69	1.3	1100	2.9	0.78	73	
LS 100 L	1.5	890	4.2	0.79	69	910	4.3	0.71	69	1.8	1100	4.1	0.76	72	
LS 112 M	2.2	895	5.8	0.80	72	915	5.8	0.72	73	2.6	1100	5.5	0.78	76	
LS 132 S	3	948	7	0.81	80.1	960	6.8	0.76	81.1	3.6	1152	6.9	0.80	82.4	
LS 132 M	4	953	9.4	0.78	83.1	965	9.2	0.73	83.4	4.8	1158	9.3	0.77	84.7	
LS 132 M	5.5	953	13.5	0.74	83.7	963	13.4	0.68	83.9	6.6	1155	13.3	0.72	85.3	
LS 160 M	7.5	962	16.6	0.81	84.5	972	15.9	0.77	85.2	8.6	1167	16	0.79	85.2	
LS 160 L	11	962	23.9	0.81	86.3	970	23	0.77	86.4	12.5	1167	23	0.79	86.3	
LS 180 LR	15	970	31.1	0.83	88.4	972	29.8	0.79	88.7	17	1172	29.7	0.81	88.7	
LS 200 LT	18.5	965	38.2	0.83	88.6	975	36.4	0.79	89.6	21	1170	36.6	0.81	89	
LS 200 L	22	967	44.8	0.83	89.8	975	42.9	0.79	90.3	25	1172	43.1	0.81	89.9	
LS 225 MR	30	965	61.3	0.83	89.6	972	57.8	0.8	90.2	34	1168	58.6	0.81	89.9	
LS 250 ME	37	974	74.3	0.82	92.3	980	69.2	0.8	93	42	1174	70	0.81	93	
LS 280 SC	45	974	90.3	0.82	92.3	980	84.1	0.8	93	52	1174	86.6	0.81	93	
LS 280 MC	55	974	111	0.82	92.1	980	102.8	0.8	93	63	1174	104	0.82	92.8	
LS 315 SP	75	978	146	0.84	93	982	138	0.81	93.4	86	1178	138	0.84	93.4	
LS 315 MP	90	976	171	0.86	92.9	982	160	0.84	93.2	103	1178	161	0.86	93.3	
LS 315 MR	110	976	209	0.86	93.1	982	194	0.84	93.7	126	1178	196	0.86	93.6	
LS 315 MR	132	984	252	0.84	94.7	988	239	0.81	94.9	152	1186	240	0.84	94.8	

Note: For mains supplies with different voltages, see section D2.2.4.

3-phase TEFV induction motors LS aluminium alloy frame Electrical characteristics

E1 - Selection data: Single-speed

8
poles
750 min⁻¹

IP 55 - S1
Cl. F - ΔT 80 K

MAINS SUPPLY Δ 230 / Y 400 V or Δ 400 V

50 Hz

Type	Rated power at 50 Hz	Rated speed	Rated torque	Rated current	Power factor			Efficiency			Starting current/ Rated current	Starting torque/ Rated torque	Max. torque/ Rated torque	Rated apparent power	Torque* curve	Moment of inertia	Weight
	P_N kW	N_N min ⁻¹	C_N N.m	$I_N (400V)$ A	50 %	$\cos \varphi$ 75 %	100 %	50 %	η 75 %	100 %	I_D/I_N	M_D/M_N	M_M/M_N	kVA_N	N°	J kg.m ²	IM B3 kg
LS 71 L	0.12	650	1.7	0.72	0.40	0.45	0.55	36	42	44	2.1	1.3	1.5	0.50	3	0.0013	8
LS 80 L	0.18	705	2.4	0.79	0.45	0.54	0.63	43	48	52	2.9	1.5	1.9	0.55	8	0.0031	9.7
LS 80 L	0.25	700	3.4	0.98	0.51	0.60	0.68	45	52	54	2.8	1.7	1.9	0.68	8	0.0041	11.3
LS 90 S	0.37	685	5.2	1.20	0.52	0.63	0.72	56	62	62	3.8	1.7	1.8	0.83	8	0.0038	13.5
LS 90 L	0.55	670	7.8	1.7	0.52	0.61	0.72	59	62	63.5	3.5	1.7	1.7	1.2	8	0.0047	15.2
LS 100 L	0.75	670	10.7	2.4	0.47	0.58	0.71	55	61.5	63.5	3.5	1.8	2.2	1.7	7	0.0047	18
LS 100 L	1.1	670	15.7	3.7	0.49	0.60	0.68	58	62.5	63	3.7	2	2.2	2.6	7	0.0068	21.8
LS 112 MG	1.5	710	20.2	4.7	0.43	0.55	0.64	62.5	69	72	3.8	2	2.1	3.3	7	0.015	24
LS 132 SM	2.2	713	30.2	6.1	0.45	0.56	0.68	71	77.5	77.1	4	1.7	2	4.2	8	0.025	45.6
LS 132 M	3	712	40.7	8	0.45	0.56	0.65	79	82.9	79.8	4.3	1.9	2.2	5.5	8	0.033	53.9
LS 160 M	4	718	53.2	11	0.43	0.55	0.63	81.3	83.4	83.3	3.9	1.7	2.3	7.6	8	0.068	84
LS 160 M	5.5	716	73.4	15.1	0.43	0.55	0.63	81.8	83.5	83.3	3.9	1.7	2.3	10.5	8	0.071	89
LS 160 L	7.5	714	100	20.6	0.43	0.55	0.63	82.6	84	83.4	3.9	1.9	2.3	14.3	8	0.09	101
LS 180 L	11	720	146	25.6	0.57	0.68	0.72	84.2	86.3	86	3.8	1.4	1.9	17.8	8	0.205	140
LS 200 L	15	725	198	32.9	0.57	0.7	0.75	86.3	87.9	87.7	4.4	1.6	2.1	22.8	8	0.27	185
LS 225 ST	18.5	725	244	42.4	0.54	0.66	0.72	86.2	87.7	87.5	4.2	1.6	2.1	29.4	8	0.33	210
LS 225 MR	22	725	290	51.9	0.51	0.63	0.7	85.1	87.2	87.4	4.4	1.9	2.3	36	8	0.4	240
LS 250 ME	30	730	392	60.3	0.63	0.73	0.79	90.1	91.2	90.9	5.8	1.9	2.7	41.8	8	0.99	330
LS 280 SC	37	730	484	74.3	0.63	0.73	0.79	90.7	91.4	91	5.6	1.8	2.6	51.5	8	1.19	370
LS 280 MD	45	728	590	91.4	0.63	0.73	0.78	91.1	91.7	91.1	5.4	1.8	2.6	63.3	8	1.39	430
LS 315 SP	55	738	712	105	0.71	0.78	0.81	92.2	93.2	93.2	5.4	1.8	2.4	72.9	8	3.1	660
LS 315 MR	75	738	970	143	0.71	0.78	0.81	93.1	93.8	93.6	5.4	1.8	2.4	98.9	8	4.38	815

For motors with a greater number of poles, see the table on page 66.

* Torque curve

Noise level

section D4.4 - page 61

section D6.1 - page 71

3-phase TEFV induction motors LS aluminium alloy frame Electrical characteristics

E1 - Selection data: single-speed

8
poles
900 min⁻¹

Type	MAINS SUPPLY 380 V					MAINS SUPPLY 415 V					MAINS SUPPLY 460 V can be used from 440V to 480V				
	50 Hz					50 Hz					60 Hz				
	Rated power at 50 Hz	Rated speed	Rated current	Power factor	Efficiency	Rated speed	Rated current	Power factor	Efficiency	Rated power at 60 Hz	Rated speed	Rated current	Power factor	Efficiency	
	P_N kW	N_N min ⁻¹	I_N A	$\cos \varphi$	η %	N_N min ⁻¹	I_N A	$\cos \varphi$	η %	P_N kW	N_N min ⁻¹	I_N A	$\cos \varphi$	η %	
LS 71 L	0.12	630	0.70	0.60	43.6	670	0.70	0.50	44						
LS 80 L	0.18	700	0.77	0.66	53.5	710	0.80	0.61	51.6	0.22	860	0.77	0.62	58	
LS 80 L	0.25	695	0.83	0.75	61	705	1.03	0.62	54.5	0.30	850	0.97	0.65	59.5	
LS 90 S	0.37	670	1.22	0.75	61.5	690	1.20	0.69	62	0.45	835	1.20	0.71	66.5	
LS 90 L	0.55	655	1.8	0.74	62	680	1.8	0.67	64	0.66	810	1.8	0.72	66.5	
LS 100 L	0.75	660	2.4	0.76	62	675	2.5	0.69	61	0.90	820	2.3	0.72	68	
LS 100 L	1.1	655	3.6	0.73	63	675	3.8	0.64	62	1.3	820	3.6	0.68	67	
LS 112 MG	1.5	705	4.7	0.68	71	720	4.8	0.61	72	1.8	860	4.5	0.66	76	
LS 132 SM	2.2	704	6.1	0.72	76.3	716	6.1	0.65	76.6	2.6	857	6	0.69	79	
LS 132 M	3	705	8.1	0.71	79.3	715	8.1	0.65	79.8	3.6	870	8	0.69	81.8	
LS 160 M	4	714	11.1	0.66	82.6	722	11.1	0.6	83.4	4.6	868	10.6	0.64	85.2	
LS 160 M	5.5	712	15.3	0.66	82.6	720	15.3	0.6	83.4	6.3	866	14.5	0.64	85.2	
LS 160 L	7.5	708	20.6	0.67	82.7	716	20.8	0.6	83.5	8.6	862	19.5	0.65	85.2	
LS 180 L	11	715	26	0.75	85.6	725	25.3	0.7	86.3	12.5	870	25.3	0.72	86	
LS 200 L	15	720	34.1	0.77	86.8	725	33.2	0.72	87.2	17	875	32.4	0.75	87.7	
LS 225 ST	18.5	720	43.1	0.75	87	725	42.1	0.7	87.4	21	875	41.8	0.72	87.5	
LS 225 MR	22	720	52.4	0.73	87.4	730	53	0.66	86.8	25	875	51.3	0.7	87.4	
LS 250 ME	30	728	62.2	0.81	90.5	732	58	0.79	91.1	34	878	56.9	0.82	91.4	
LS 280 SC	37	728	76.6	0.81	90.6	732	71	0.79	91.2	42	878	70.3	0.82	91.5	
LS 280 MD	45	726	94.2	0.8	90.7	730	89	0.77	91.3	52	876	89	0.8	91.7	
LS 315 SP	55	736	109	0.82	93.1	740	102	0.8	93.4	63	886	104	0.81	93.5	
LS 315 MR	75	736	149	0.82	93.3	740	139	0.8	93.7	86	886	142	0.81	93.8	

For motors with a greater number of poles, see the table on page 66.

Note: For mains supplies with different voltages, see section D2.2.4.

3-phase TEFV induction motors LS aluminium alloy frame Electrical characteristics

E2 - Selection data: two-speed

The performance data for multi-speed motors are detailed for the most widely used models, with simplified tables giving a summary of the other available standard builds, along with modified standard builds.

**2-4
poles**
3000-1500 min⁻¹

IP 55 - Cl. F - S1
Centrifugal applications
1 winding (Dahlander)

MAINS SUPPLY 400 V 50 Hz

Type	Rated power at 50 Hz	Rated speed	Rated current	Power factor	Efficiency	Starting current / Rated current	Starting torque / Rated torque	Maximum torque / Rated torque	Moment of inertia	Weight																																																																																																																																																																																																																																																																																																																																																																						
	P_N kW	N_N min ⁻¹	$I_N(400 V)$ A	$\cos \varphi$	η %	I_D/I_N	M_D/M_N	M_M/M_N	J kg.m ²	IM B3 kg																																																																																																																																																																																																																																																																																																																																																																						
LS 71 M	0.37	2840	1.2	0.8	72	4.3	2	2.4	0.0085	7.3																																																																																																																																																																																																																																																																																																																																																																						
	0.075	1440	0.3	0.65	70	4.6	1.9	2.5			LS 71 L	0.55	2830	1.4	0.85	71	4.2	1.88	2.3	0.0011	8.3	0.11	1430	0.35	0.7	69	4.5	1.7	2.4	LS 80 L	1.1	2810	2.5	0.87	72	5.2	2	2.27	0.0042	10.9	0.25	1420	0.66	0.78	70	4.6	1.9	1.95	LS 90 S	1.5	2810	3.7	0.86	68.5	4.2	1.77	1.99	0.0039	14	0.35	1440	0.8	0.81	75.7	5.4	1.76	2.12	LS 90 L	2.2	2840	4.2	0.87	74	5.2	1.95	2.01	0.0049	15.2	0.6	1420	1.4	0.84	75.6	4.4	1.71	1.98	LS 100 L	3	2885	6.5	0.85	78.8	6.3	2.26	2.37	0.0062	24.5	0.8	1440	1.7	0.82	80.2	5.9	2.15	2.38	LS 112 MU	4.5	2915	9.4	0.85	81.6	6.9	2.25	2.53	0.015	37	1.3	1450	2.8	0.81	82.2	5.7	2.11	2.51	LS 132 SM	6	2890	13.1	0.85	78	5.7	2.04	2.26	0.0334	50	1.6	1450	3.4	0.83	81.6	5.6	1.82	2.46	LS 132 M	9	2920	18.7	0.85	82.4	7.8	2.42	2.52	0.0385	60	2.5	1450	5.2	0.82	84.6	6.7	2.03	2.78	LS 160 M	13.5	2935	24.8	0.89	88.2	8	2.3	3.2	0.068	85	3.3	1469	6.4	0.85	86.9	6.9	2.2	3.1	LS 160 L	19	2936	34.9	0.88	89.3	7.8	2.5	3.1	0.085	97	4.5	1470	8.6	0.84	89.7	7.4	2.5	3.2	LS 180 LU	24	2955	45	0.87	88.5	8.7	2.8	3.4	0.137	147	8	1470	14.5	0.89	89.5	5.8	2.3	2.3	LS 200 L	31	2955	55.9	0.91	88	8	2.4	3	0.240	200	11	1465	20.2	0.89	88.5	5.2	1.6	1.9	LS 200 LU	40	2955	71.3	0.9	90	8	2.8	3.2	0.270	228	14	1465	25.1	0.88	91.5	5.2	1.7	2.1	LS 225 MG	50	2970	87.2	0.9	92	8.8	2.6	3.5	0.633	320	17	1476	30.9	0.86	92.2	5.5	2.1	2.2	LS 250 ME	59	2970	103	0.9	92	8.8	2.6	3.5	0.73	340	20	1476	36.4	0.86	92.2	5.5	2.1	2.2	LS 250 ME	70	2970	122	0.9	92	8.8	2.6	3.5	0.83	380	24	1476	43.7	0.86	92.2	5.5	2.1	2.2	LS 280 MD	85	2970	148	0.9	92	8.8	2.6	3.5	1.03	450	30	1476	54.6	0.86	92.2	5.5	2.1	2.2	LS 315 MP	100	2975	168	0.92	93.3	8.5	2.5	3.3	2.79	750	35	1485	60.9	0.88	94.3	5.5	2.1	2.1	LS 315 MR	118	2975	198	0.92	93.3	8.5	2.5	3.3	3.27	845	40	1485	69.6	0.88	94.3
LS 71 L	0.55	2830	1.4	0.85	71	4.2	1.88	2.3	0.0011	8.3																																																																																																																																																																																																																																																																																																																																																																						
	0.11	1430	0.35	0.7	69	4.5	1.7	2.4			LS 80 L	1.1	2810	2.5	0.87	72	5.2	2	2.27	0.0042	10.9	0.25	1420	0.66	0.78	70	4.6	1.9	1.95	LS 90 S	1.5	2810	3.7	0.86	68.5	4.2	1.77	1.99	0.0039	14	0.35	1440	0.8	0.81	75.7	5.4	1.76	2.12	LS 90 L	2.2	2840	4.2	0.87	74	5.2	1.95	2.01	0.0049	15.2	0.6	1420	1.4	0.84	75.6	4.4	1.71	1.98	LS 100 L	3	2885	6.5	0.85	78.8	6.3	2.26	2.37	0.0062	24.5	0.8	1440	1.7	0.82	80.2	5.9	2.15	2.38	LS 112 MU	4.5	2915	9.4	0.85	81.6	6.9	2.25	2.53	0.015	37	1.3	1450	2.8	0.81	82.2	5.7	2.11	2.51	LS 132 SM	6	2890	13.1	0.85	78	5.7	2.04	2.26	0.0334	50	1.6	1450	3.4	0.83	81.6	5.6	1.82	2.46	LS 132 M	9	2920	18.7	0.85	82.4	7.8	2.42	2.52	0.0385	60	2.5	1450	5.2	0.82	84.6	6.7	2.03	2.78	LS 160 M	13.5	2935	24.8	0.89	88.2	8	2.3	3.2	0.068	85	3.3	1469	6.4	0.85	86.9	6.9	2.2	3.1	LS 160 L	19	2936	34.9	0.88	89.3	7.8	2.5	3.1	0.085	97	4.5	1470	8.6	0.84	89.7	7.4	2.5	3.2	LS 180 LU	24	2955	45	0.87	88.5	8.7	2.8	3.4	0.137	147	8	1470	14.5	0.89	89.5	5.8	2.3	2.3	LS 200 L	31	2955	55.9	0.91	88	8	2.4	3	0.240	200	11	1465	20.2	0.89	88.5	5.2	1.6	1.9	LS 200 LU	40	2955	71.3	0.9	90	8	2.8	3.2	0.270	228	14	1465	25.1	0.88	91.5	5.2	1.7	2.1	LS 225 MG	50	2970	87.2	0.9	92	8.8	2.6	3.5	0.633	320	17	1476	30.9	0.86	92.2	5.5	2.1	2.2	LS 250 ME	59	2970	103	0.9	92	8.8	2.6	3.5	0.73	340	20	1476	36.4	0.86	92.2	5.5	2.1	2.2	LS 250 ME	70	2970	122	0.9	92	8.8	2.6	3.5	0.83	380	24	1476	43.7	0.86	92.2	5.5	2.1	2.2	LS 280 MD	85	2970	148	0.9	92	8.8	2.6	3.5	1.03	450	30	1476	54.6	0.86	92.2	5.5	2.1	2.2	LS 315 MP	100	2975	168	0.92	93.3	8.5	2.5	3.3	2.79	750	35	1485	60.9	0.88	94.3	5.5	2.1	2.1	LS 315 MR	118	2975	198	0.92	93.3	8.5	2.5	3.3	3.27	845	40	1485	69.6	0.88	94.3	5.5	2.1	2.1																
LS 80 L	1.1	2810	2.5	0.87	72	5.2	2	2.27	0.0042	10.9																																																																																																																																																																																																																																																																																																																																																																						
	0.25	1420	0.66	0.78	70	4.6	1.9	1.95			LS 90 S	1.5	2810	3.7	0.86	68.5	4.2	1.77	1.99	0.0039	14	0.35	1440	0.8	0.81	75.7	5.4	1.76	2.12	LS 90 L	2.2	2840	4.2	0.87	74	5.2	1.95	2.01	0.0049	15.2	0.6	1420	1.4	0.84	75.6	4.4	1.71	1.98	LS 100 L	3	2885	6.5	0.85	78.8	6.3	2.26	2.37	0.0062	24.5	0.8	1440	1.7	0.82	80.2	5.9	2.15	2.38	LS 112 MU	4.5	2915	9.4	0.85	81.6	6.9	2.25	2.53	0.015	37	1.3	1450	2.8	0.81	82.2	5.7	2.11	2.51	LS 132 SM	6	2890	13.1	0.85	78	5.7	2.04	2.26	0.0334	50	1.6	1450	3.4	0.83	81.6	5.6	1.82	2.46	LS 132 M	9	2920	18.7	0.85	82.4	7.8	2.42	2.52	0.0385	60	2.5	1450	5.2	0.82	84.6	6.7	2.03	2.78	LS 160 M	13.5	2935	24.8	0.89	88.2	8	2.3	3.2	0.068	85	3.3	1469	6.4	0.85	86.9	6.9	2.2	3.1	LS 160 L	19	2936	34.9	0.88	89.3	7.8	2.5	3.1	0.085	97	4.5	1470	8.6	0.84	89.7	7.4	2.5	3.2	LS 180 LU	24	2955	45	0.87	88.5	8.7	2.8	3.4	0.137	147	8	1470	14.5	0.89	89.5	5.8	2.3	2.3	LS 200 L	31	2955	55.9	0.91	88	8	2.4	3	0.240	200	11	1465	20.2	0.89	88.5	5.2	1.6	1.9	LS 200 LU	40	2955	71.3	0.9	90	8	2.8	3.2	0.270	228	14	1465	25.1	0.88	91.5	5.2	1.7	2.1	LS 225 MG	50	2970	87.2	0.9	92	8.8	2.6	3.5	0.633	320	17	1476	30.9	0.86	92.2	5.5	2.1	2.2	LS 250 ME	59	2970	103	0.9	92	8.8	2.6	3.5	0.73	340	20	1476	36.4	0.86	92.2	5.5	2.1	2.2	LS 250 ME	70	2970	122	0.9	92	8.8	2.6	3.5	0.83	380	24	1476	43.7	0.86	92.2	5.5	2.1	2.2	LS 280 MD	85	2970	148	0.9	92	8.8	2.6	3.5	1.03	450	30	1476	54.6	0.86	92.2	5.5	2.1	2.2	LS 315 MP	100	2975	168	0.92	93.3	8.5	2.5	3.3	2.79	750	35	1485	60.9	0.88	94.3	5.5	2.1	2.1	LS 315 MR	118	2975	198	0.92	93.3	8.5	2.5	3.3	3.27	845	40	1485	69.6	0.88	94.3	5.5	2.1	2.1																																			
LS 90 S	1.5	2810	3.7	0.86	68.5	4.2	1.77	1.99	0.0039	14																																																																																																																																																																																																																																																																																																																																																																						
	0.35	1440	0.8	0.81	75.7	5.4	1.76	2.12			LS 90 L	2.2	2840	4.2	0.87	74	5.2	1.95	2.01	0.0049	15.2	0.6	1420	1.4	0.84	75.6	4.4	1.71	1.98	LS 100 L	3	2885	6.5	0.85	78.8	6.3	2.26	2.37	0.0062	24.5	0.8	1440	1.7	0.82	80.2	5.9	2.15	2.38	LS 112 MU	4.5	2915	9.4	0.85	81.6	6.9	2.25	2.53	0.015	37	1.3	1450	2.8	0.81	82.2	5.7	2.11	2.51	LS 132 SM	6	2890	13.1	0.85	78	5.7	2.04	2.26	0.0334	50	1.6	1450	3.4	0.83	81.6	5.6	1.82	2.46	LS 132 M	9	2920	18.7	0.85	82.4	7.8	2.42	2.52	0.0385	60	2.5	1450	5.2	0.82	84.6	6.7	2.03	2.78	LS 160 M	13.5	2935	24.8	0.89	88.2	8	2.3	3.2	0.068	85	3.3	1469	6.4	0.85	86.9	6.9	2.2	3.1	LS 160 L	19	2936	34.9	0.88	89.3	7.8	2.5	3.1	0.085	97	4.5	1470	8.6	0.84	89.7	7.4	2.5	3.2	LS 180 LU	24	2955	45	0.87	88.5	8.7	2.8	3.4	0.137	147	8	1470	14.5	0.89	89.5	5.8	2.3	2.3	LS 200 L	31	2955	55.9	0.91	88	8	2.4	3	0.240	200	11	1465	20.2	0.89	88.5	5.2	1.6	1.9	LS 200 LU	40	2955	71.3	0.9	90	8	2.8	3.2	0.270	228	14	1465	25.1	0.88	91.5	5.2	1.7	2.1	LS 225 MG	50	2970	87.2	0.9	92	8.8	2.6	3.5	0.633	320	17	1476	30.9	0.86	92.2	5.5	2.1	2.2	LS 250 ME	59	2970	103	0.9	92	8.8	2.6	3.5	0.73	340	20	1476	36.4	0.86	92.2	5.5	2.1	2.2	LS 250 ME	70	2970	122	0.9	92	8.8	2.6	3.5	0.83	380	24	1476	43.7	0.86	92.2	5.5	2.1	2.2	LS 280 MD	85	2970	148	0.9	92	8.8	2.6	3.5	1.03	450	30	1476	54.6	0.86	92.2	5.5	2.1	2.2	LS 315 MP	100	2975	168	0.92	93.3	8.5	2.5	3.3	2.79	750	35	1485	60.9	0.88	94.3	5.5	2.1	2.1	LS 315 MR	118	2975	198	0.92	93.3	8.5	2.5	3.3	3.27	845	40	1485	69.6	0.88	94.3	5.5	2.1	2.1																																																						
LS 90 L	2.2	2840	4.2	0.87	74	5.2	1.95	2.01	0.0049	15.2																																																																																																																																																																																																																																																																																																																																																																						
	0.6	1420	1.4	0.84	75.6	4.4	1.71	1.98			LS 100 L	3	2885	6.5	0.85	78.8	6.3	2.26	2.37	0.0062	24.5	0.8	1440	1.7	0.82	80.2	5.9	2.15	2.38	LS 112 MU	4.5	2915	9.4	0.85	81.6	6.9	2.25	2.53	0.015	37	1.3	1450	2.8	0.81	82.2	5.7	2.11	2.51	LS 132 SM	6	2890	13.1	0.85	78	5.7	2.04	2.26	0.0334	50	1.6	1450	3.4	0.83	81.6	5.6	1.82	2.46	LS 132 M	9	2920	18.7	0.85	82.4	7.8	2.42	2.52	0.0385	60	2.5	1450	5.2	0.82	84.6	6.7	2.03	2.78	LS 160 M	13.5	2935	24.8	0.89	88.2	8	2.3	3.2	0.068	85	3.3	1469	6.4	0.85	86.9	6.9	2.2	3.1	LS 160 L	19	2936	34.9	0.88	89.3	7.8	2.5	3.1	0.085	97	4.5	1470	8.6	0.84	89.7	7.4	2.5	3.2	LS 180 LU	24	2955	45	0.87	88.5	8.7	2.8	3.4	0.137	147	8	1470	14.5	0.89	89.5	5.8	2.3	2.3	LS 200 L	31	2955	55.9	0.91	88	8	2.4	3	0.240	200	11	1465	20.2	0.89	88.5	5.2	1.6	1.9	LS 200 LU	40	2955	71.3	0.9	90	8	2.8	3.2	0.270	228	14	1465	25.1	0.88	91.5	5.2	1.7	2.1	LS 225 MG	50	2970	87.2	0.9	92	8.8	2.6	3.5	0.633	320	17	1476	30.9	0.86	92.2	5.5	2.1	2.2	LS 250 ME	59	2970	103	0.9	92	8.8	2.6	3.5	0.73	340	20	1476	36.4	0.86	92.2	5.5	2.1	2.2	LS 250 ME	70	2970	122	0.9	92	8.8	2.6	3.5	0.83	380	24	1476	43.7	0.86	92.2	5.5	2.1	2.2	LS 280 MD	85	2970	148	0.9	92	8.8	2.6	3.5	1.03	450	30	1476	54.6	0.86	92.2	5.5	2.1	2.2	LS 315 MP	100	2975	168	0.92	93.3	8.5	2.5	3.3	2.79	750	35	1485	60.9	0.88	94.3	5.5	2.1	2.1	LS 315 MR	118	2975	198	0.92	93.3	8.5	2.5	3.3	3.27	845	40	1485	69.6	0.88	94.3	5.5	2.1	2.1																																																																									
LS 100 L	3	2885	6.5	0.85	78.8	6.3	2.26	2.37	0.0062	24.5																																																																																																																																																																																																																																																																																																																																																																						
	0.8	1440	1.7	0.82	80.2	5.9	2.15	2.38			LS 112 MU	4.5	2915	9.4	0.85	81.6	6.9	2.25	2.53	0.015	37	1.3	1450	2.8	0.81	82.2	5.7	2.11	2.51	LS 132 SM	6	2890	13.1	0.85	78	5.7	2.04	2.26	0.0334	50	1.6	1450	3.4	0.83	81.6	5.6	1.82	2.46	LS 132 M	9	2920	18.7	0.85	82.4	7.8	2.42	2.52	0.0385	60	2.5	1450	5.2	0.82	84.6	6.7	2.03	2.78	LS 160 M	13.5	2935	24.8	0.89	88.2	8	2.3	3.2	0.068	85	3.3	1469	6.4	0.85	86.9	6.9	2.2	3.1	LS 160 L	19	2936	34.9	0.88	89.3	7.8	2.5	3.1	0.085	97	4.5	1470	8.6	0.84	89.7	7.4	2.5	3.2	LS 180 LU	24	2955	45	0.87	88.5	8.7	2.8	3.4	0.137	147	8	1470	14.5	0.89	89.5	5.8	2.3	2.3	LS 200 L	31	2955	55.9	0.91	88	8	2.4	3	0.240	200	11	1465	20.2	0.89	88.5	5.2	1.6	1.9	LS 200 LU	40	2955	71.3	0.9	90	8	2.8	3.2	0.270	228	14	1465	25.1	0.88	91.5	5.2	1.7	2.1	LS 225 MG	50	2970	87.2	0.9	92	8.8	2.6	3.5	0.633	320	17	1476	30.9	0.86	92.2	5.5	2.1	2.2	LS 250 ME	59	2970	103	0.9	92	8.8	2.6	3.5	0.73	340	20	1476	36.4	0.86	92.2	5.5	2.1	2.2	LS 250 ME	70	2970	122	0.9	92	8.8	2.6	3.5	0.83	380	24	1476	43.7	0.86	92.2	5.5	2.1	2.2	LS 280 MD	85	2970	148	0.9	92	8.8	2.6	3.5	1.03	450	30	1476	54.6	0.86	92.2	5.5	2.1	2.2	LS 315 MP	100	2975	168	0.92	93.3	8.5	2.5	3.3	2.79	750	35	1485	60.9	0.88	94.3	5.5	2.1	2.1	LS 315 MR	118	2975	198	0.92	93.3	8.5	2.5	3.3	3.27	845	40	1485	69.6	0.88	94.3	5.5	2.1	2.1																																																																																												
LS 112 MU	4.5	2915	9.4	0.85	81.6	6.9	2.25	2.53	0.015	37																																																																																																																																																																																																																																																																																																																																																																						
	1.3	1450	2.8	0.81	82.2	5.7	2.11	2.51			LS 132 SM	6	2890	13.1	0.85	78	5.7	2.04	2.26	0.0334	50	1.6	1450	3.4	0.83	81.6	5.6	1.82	2.46	LS 132 M	9	2920	18.7	0.85	82.4	7.8	2.42	2.52	0.0385	60	2.5	1450	5.2	0.82	84.6	6.7	2.03	2.78	LS 160 M	13.5	2935	24.8	0.89	88.2	8	2.3	3.2	0.068	85	3.3	1469	6.4	0.85	86.9	6.9	2.2	3.1	LS 160 L	19	2936	34.9	0.88	89.3	7.8	2.5	3.1	0.085	97	4.5	1470	8.6	0.84	89.7	7.4	2.5	3.2	LS 180 LU	24	2955	45	0.87	88.5	8.7	2.8	3.4	0.137	147	8	1470	14.5	0.89	89.5	5.8	2.3	2.3	LS 200 L	31	2955	55.9	0.91	88	8	2.4	3	0.240	200	11	1465	20.2	0.89	88.5	5.2	1.6	1.9	LS 200 LU	40	2955	71.3	0.9	90	8	2.8	3.2	0.270	228	14	1465	25.1	0.88	91.5	5.2	1.7	2.1	LS 225 MG	50	2970	87.2	0.9	92	8.8	2.6	3.5	0.633	320	17	1476	30.9	0.86	92.2	5.5	2.1	2.2	LS 250 ME	59	2970	103	0.9	92	8.8	2.6	3.5	0.73	340	20	1476	36.4	0.86	92.2	5.5	2.1	2.2	LS 250 ME	70	2970	122	0.9	92	8.8	2.6	3.5	0.83	380	24	1476	43.7	0.86	92.2	5.5	2.1	2.2	LS 280 MD	85	2970	148	0.9	92	8.8	2.6	3.5	1.03	450	30	1476	54.6	0.86	92.2	5.5	2.1	2.2	LS 315 MP	100	2975	168	0.92	93.3	8.5	2.5	3.3	2.79	750	35	1485	60.9	0.88	94.3	5.5	2.1	2.1	LS 315 MR	118	2975	198	0.92	93.3	8.5	2.5	3.3	3.27	845	40	1485	69.6	0.88	94.3	5.5	2.1	2.1																																																																																																															
LS 132 SM	6	2890	13.1	0.85	78	5.7	2.04	2.26	0.0334	50																																																																																																																																																																																																																																																																																																																																																																						
	1.6	1450	3.4	0.83	81.6	5.6	1.82	2.46			LS 132 M	9	2920	18.7	0.85	82.4	7.8	2.42	2.52	0.0385	60	2.5	1450	5.2	0.82	84.6	6.7	2.03	2.78	LS 160 M	13.5	2935	24.8	0.89	88.2	8	2.3	3.2	0.068	85	3.3	1469	6.4	0.85	86.9	6.9	2.2	3.1	LS 160 L	19	2936	34.9	0.88	89.3	7.8	2.5	3.1	0.085	97	4.5	1470	8.6	0.84	89.7	7.4	2.5	3.2	LS 180 LU	24	2955	45	0.87	88.5	8.7	2.8	3.4	0.137	147	8	1470	14.5	0.89	89.5	5.8	2.3	2.3	LS 200 L	31	2955	55.9	0.91	88	8	2.4	3	0.240	200	11	1465	20.2	0.89	88.5	5.2	1.6	1.9	LS 200 LU	40	2955	71.3	0.9	90	8	2.8	3.2	0.270	228	14	1465	25.1	0.88	91.5	5.2	1.7	2.1	LS 225 MG	50	2970	87.2	0.9	92	8.8	2.6	3.5	0.633	320	17	1476	30.9	0.86	92.2	5.5	2.1	2.2	LS 250 ME	59	2970	103	0.9	92	8.8	2.6	3.5	0.73	340	20	1476	36.4	0.86	92.2	5.5	2.1	2.2	LS 250 ME	70	2970	122	0.9	92	8.8	2.6	3.5	0.83	380	24	1476	43.7	0.86	92.2	5.5	2.1	2.2	LS 280 MD	85	2970	148	0.9	92	8.8	2.6	3.5	1.03	450	30	1476	54.6	0.86	92.2	5.5	2.1	2.2	LS 315 MP	100	2975	168	0.92	93.3	8.5	2.5	3.3	2.79	750	35	1485	60.9	0.88	94.3	5.5	2.1	2.1	LS 315 MR	118	2975	198	0.92	93.3	8.5	2.5	3.3	3.27	845	40	1485	69.6	0.88	94.3	5.5	2.1	2.1																																																																																																																																		
LS 132 M	9	2920	18.7	0.85	82.4	7.8	2.42	2.52	0.0385	60																																																																																																																																																																																																																																																																																																																																																																						
	2.5	1450	5.2	0.82	84.6	6.7	2.03	2.78			LS 160 M	13.5	2935	24.8	0.89	88.2	8	2.3	3.2	0.068	85	3.3	1469	6.4	0.85	86.9	6.9	2.2	3.1	LS 160 L	19	2936	34.9	0.88	89.3	7.8	2.5	3.1	0.085	97	4.5	1470	8.6	0.84	89.7	7.4	2.5	3.2	LS 180 LU	24	2955	45	0.87	88.5	8.7	2.8	3.4	0.137	147	8	1470	14.5	0.89	89.5	5.8	2.3	2.3	LS 200 L	31	2955	55.9	0.91	88	8	2.4	3	0.240	200	11	1465	20.2	0.89	88.5	5.2	1.6	1.9	LS 200 LU	40	2955	71.3	0.9	90	8	2.8	3.2	0.270	228	14	1465	25.1	0.88	91.5	5.2	1.7	2.1	LS 225 MG	50	2970	87.2	0.9	92	8.8	2.6	3.5	0.633	320	17	1476	30.9	0.86	92.2	5.5	2.1	2.2	LS 250 ME	59	2970	103	0.9	92	8.8	2.6	3.5	0.73	340	20	1476	36.4	0.86	92.2	5.5	2.1	2.2	LS 250 ME	70	2970	122	0.9	92	8.8	2.6	3.5	0.83	380	24	1476	43.7	0.86	92.2	5.5	2.1	2.2	LS 280 MD	85	2970	148	0.9	92	8.8	2.6	3.5	1.03	450	30	1476	54.6	0.86	92.2	5.5	2.1	2.2	LS 315 MP	100	2975	168	0.92	93.3	8.5	2.5	3.3	2.79	750	35	1485	60.9	0.88	94.3	5.5	2.1	2.1	LS 315 MR	118	2975	198	0.92	93.3	8.5	2.5	3.3	3.27	845	40	1485	69.6	0.88	94.3	5.5	2.1	2.1																																																																																																																																																					
LS 160 M	13.5	2935	24.8	0.89	88.2	8	2.3	3.2	0.068	85																																																																																																																																																																																																																																																																																																																																																																						
	3.3	1469	6.4	0.85	86.9	6.9	2.2	3.1			LS 160 L	19	2936	34.9	0.88	89.3	7.8	2.5	3.1	0.085	97	4.5	1470	8.6	0.84	89.7	7.4	2.5	3.2	LS 180 LU	24	2955	45	0.87	88.5	8.7	2.8	3.4	0.137	147	8	1470	14.5	0.89	89.5	5.8	2.3	2.3	LS 200 L	31	2955	55.9	0.91	88	8	2.4	3	0.240	200	11	1465	20.2	0.89	88.5	5.2	1.6	1.9	LS 200 LU	40	2955	71.3	0.9	90	8	2.8	3.2	0.270	228	14	1465	25.1	0.88	91.5	5.2	1.7	2.1	LS 225 MG	50	2970	87.2	0.9	92	8.8	2.6	3.5	0.633	320	17	1476	30.9	0.86	92.2	5.5	2.1	2.2	LS 250 ME	59	2970	103	0.9	92	8.8	2.6	3.5	0.73	340	20	1476	36.4	0.86	92.2	5.5	2.1	2.2	LS 250 ME	70	2970	122	0.9	92	8.8	2.6	3.5	0.83	380	24	1476	43.7	0.86	92.2	5.5	2.1	2.2	LS 280 MD	85	2970	148	0.9	92	8.8	2.6	3.5	1.03	450	30	1476	54.6	0.86	92.2	5.5	2.1	2.2	LS 315 MP	100	2975	168	0.92	93.3	8.5	2.5	3.3	2.79	750	35	1485	60.9	0.88	94.3	5.5	2.1	2.1	LS 315 MR	118	2975	198	0.92	93.3	8.5	2.5	3.3	3.27	845	40	1485	69.6	0.88	94.3	5.5	2.1	2.1																																																																																																																																																																								
LS 160 L	19	2936	34.9	0.88	89.3	7.8	2.5	3.1	0.085	97																																																																																																																																																																																																																																																																																																																																																																						
	4.5	1470	8.6	0.84	89.7	7.4	2.5	3.2			LS 180 LU	24	2955	45	0.87	88.5	8.7	2.8	3.4	0.137	147	8	1470	14.5	0.89	89.5	5.8	2.3	2.3	LS 200 L	31	2955	55.9	0.91	88	8	2.4	3	0.240	200	11	1465	20.2	0.89	88.5	5.2	1.6	1.9	LS 200 LU	40	2955	71.3	0.9	90	8	2.8	3.2	0.270	228	14	1465	25.1	0.88	91.5	5.2	1.7	2.1	LS 225 MG	50	2970	87.2	0.9	92	8.8	2.6	3.5	0.633	320	17	1476	30.9	0.86	92.2	5.5	2.1	2.2	LS 250 ME	59	2970	103	0.9	92	8.8	2.6	3.5	0.73	340	20	1476	36.4	0.86	92.2	5.5	2.1	2.2	LS 250 ME	70	2970	122	0.9	92	8.8	2.6	3.5	0.83	380	24	1476	43.7	0.86	92.2	5.5	2.1	2.2	LS 280 MD	85	2970	148	0.9	92	8.8	2.6	3.5	1.03	450	30	1476	54.6	0.86	92.2	5.5	2.1	2.2	LS 315 MP	100	2975	168	0.92	93.3	8.5	2.5	3.3	2.79	750	35	1485	60.9	0.88	94.3	5.5	2.1	2.1	LS 315 MR	118	2975	198	0.92	93.3	8.5	2.5	3.3	3.27	845	40	1485	69.6	0.88	94.3	5.5	2.1	2.1																																																																																																																																																																																											
LS 180 LU	24	2955	45	0.87	88.5	8.7	2.8	3.4	0.137	147																																																																																																																																																																																																																																																																																																																																																																						
	8	1470	14.5	0.89	89.5	5.8	2.3	2.3			LS 200 L	31	2955	55.9	0.91	88	8	2.4	3	0.240	200	11	1465	20.2	0.89	88.5	5.2	1.6	1.9	LS 200 LU	40	2955	71.3	0.9	90	8	2.8	3.2	0.270	228	14	1465	25.1	0.88	91.5	5.2	1.7	2.1	LS 225 MG	50	2970	87.2	0.9	92	8.8	2.6	3.5	0.633	320	17	1476	30.9	0.86	92.2	5.5	2.1	2.2	LS 250 ME	59	2970	103	0.9	92	8.8	2.6	3.5	0.73	340	20	1476	36.4	0.86	92.2	5.5	2.1	2.2	LS 250 ME	70	2970	122	0.9	92	8.8	2.6	3.5	0.83	380	24	1476	43.7	0.86	92.2	5.5	2.1	2.2	LS 280 MD	85	2970	148	0.9	92	8.8	2.6	3.5	1.03	450	30	1476	54.6	0.86	92.2	5.5	2.1	2.2	LS 315 MP	100	2975	168	0.92	93.3	8.5	2.5	3.3	2.79	750	35	1485	60.9	0.88	94.3	5.5	2.1	2.1	LS 315 MR	118	2975	198	0.92	93.3	8.5	2.5	3.3	3.27	845	40	1485	69.6	0.88	94.3	5.5	2.1	2.1																																																																																																																																																																																																														
LS 200 L	31	2955	55.9	0.91	88	8	2.4	3	0.240	200																																																																																																																																																																																																																																																																																																																																																																						
	11	1465	20.2	0.89	88.5	5.2	1.6	1.9			LS 200 LU	40	2955	71.3	0.9	90	8	2.8	3.2	0.270	228	14	1465	25.1	0.88	91.5	5.2	1.7	2.1	LS 225 MG	50	2970	87.2	0.9	92	8.8	2.6	3.5	0.633	320	17	1476	30.9	0.86	92.2	5.5	2.1	2.2	LS 250 ME	59	2970	103	0.9	92	8.8	2.6	3.5	0.73	340	20	1476	36.4	0.86	92.2	5.5	2.1	2.2	LS 250 ME	70	2970	122	0.9	92	8.8	2.6	3.5	0.83	380	24	1476	43.7	0.86	92.2	5.5	2.1	2.2	LS 280 MD	85	2970	148	0.9	92	8.8	2.6	3.5	1.03	450	30	1476	54.6	0.86	92.2	5.5	2.1	2.2	LS 315 MP	100	2975	168	0.92	93.3	8.5	2.5	3.3	2.79	750	35	1485	60.9	0.88	94.3	5.5	2.1	2.1	LS 315 MR	118	2975	198	0.92	93.3	8.5	2.5	3.3	3.27	845	40	1485	69.6	0.88	94.3	5.5	2.1	2.1																																																																																																																																																																																																																																	
LS 200 LU	40	2955	71.3	0.9	90	8	2.8	3.2	0.270	228																																																																																																																																																																																																																																																																																																																																																																						
	14	1465	25.1	0.88	91.5	5.2	1.7	2.1			LS 225 MG	50	2970	87.2	0.9	92	8.8	2.6	3.5	0.633	320	17	1476	30.9	0.86	92.2	5.5	2.1	2.2	LS 250 ME	59	2970	103	0.9	92	8.8	2.6	3.5	0.73	340	20	1476	36.4	0.86	92.2	5.5	2.1	2.2	LS 250 ME	70	2970	122	0.9	92	8.8	2.6	3.5	0.83	380	24	1476	43.7	0.86	92.2	5.5	2.1	2.2	LS 280 MD	85	2970	148	0.9	92	8.8	2.6	3.5	1.03	450	30	1476	54.6	0.86	92.2	5.5	2.1	2.2	LS 315 MP	100	2975	168	0.92	93.3	8.5	2.5	3.3	2.79	750	35	1485	60.9	0.88	94.3	5.5	2.1	2.1	LS 315 MR	118	2975	198	0.92	93.3	8.5	2.5	3.3	3.27	845	40	1485	69.6	0.88	94.3	5.5	2.1	2.1																																																																																																																																																																																																																																																				
LS 225 MG	50	2970	87.2	0.9	92	8.8	2.6	3.5	0.633	320																																																																																																																																																																																																																																																																																																																																																																						
	17	1476	30.9	0.86	92.2	5.5	2.1	2.2			LS 250 ME	59	2970	103	0.9	92	8.8	2.6	3.5	0.73	340	20	1476	36.4	0.86	92.2	5.5	2.1	2.2	LS 250 ME	70	2970	122	0.9	92	8.8	2.6	3.5	0.83	380	24	1476	43.7	0.86	92.2	5.5	2.1	2.2	LS 280 MD	85	2970	148	0.9	92	8.8	2.6	3.5	1.03	450	30	1476	54.6	0.86	92.2	5.5	2.1	2.2	LS 315 MP	100	2975	168	0.92	93.3	8.5	2.5	3.3	2.79	750	35	1485	60.9	0.88	94.3	5.5	2.1	2.1	LS 315 MR	118	2975	198	0.92	93.3	8.5	2.5	3.3	3.27	845	40	1485	69.6	0.88	94.3	5.5	2.1	2.1																																																																																																																																																																																																																																																																							
LS 250 ME	59	2970	103	0.9	92	8.8	2.6	3.5	0.73	340																																																																																																																																																																																																																																																																																																																																																																						
	20	1476	36.4	0.86	92.2	5.5	2.1	2.2			LS 250 ME	70	2970	122	0.9	92	8.8	2.6	3.5	0.83	380	24	1476	43.7	0.86	92.2	5.5	2.1	2.2	LS 280 MD	85	2970	148	0.9	92	8.8	2.6	3.5	1.03	450	30	1476	54.6	0.86	92.2	5.5	2.1	2.2	LS 315 MP	100	2975	168	0.92	93.3	8.5	2.5	3.3	2.79	750	35	1485	60.9	0.88	94.3	5.5	2.1	2.1	LS 315 MR	118	2975	198	0.92	93.3	8.5	2.5	3.3	3.27	845	40	1485	69.6	0.88	94.3	5.5	2.1	2.1																																																																																																																																																																																																																																																																																										
LS 250 ME	70	2970	122	0.9	92	8.8	2.6	3.5	0.83	380																																																																																																																																																																																																																																																																																																																																																																						
	24	1476	43.7	0.86	92.2	5.5	2.1	2.2			LS 280 MD	85	2970	148	0.9	92	8.8	2.6	3.5	1.03	450	30	1476	54.6	0.86	92.2	5.5	2.1	2.2	LS 315 MP	100	2975	168	0.92	93.3	8.5	2.5	3.3	2.79	750	35	1485	60.9	0.88	94.3	5.5	2.1	2.1	LS 315 MR	118	2975	198	0.92	93.3	8.5	2.5	3.3	3.27	845	40	1485	69.6	0.88	94.3	5.5	2.1	2.1																																																																																																																																																																																																																																																																																																													
LS 280 MD	85	2970	148	0.9	92	8.8	2.6	3.5	1.03	450																																																																																																																																																																																																																																																																																																																																																																						
	30	1476	54.6	0.86	92.2	5.5	2.1	2.2			LS 315 MP	100	2975	168	0.92	93.3	8.5	2.5	3.3	2.79	750	35	1485	60.9	0.88	94.3	5.5	2.1	2.1	LS 315 MR	118	2975	198	0.92	93.3	8.5	2.5	3.3	3.27	845	40	1485	69.6	0.88	94.3	5.5	2.1	2.1																																																																																																																																																																																																																																																																																																																																
LS 315 MP	100	2975	168	0.92	93.3	8.5	2.5	3.3	2.79	750																																																																																																																																																																																																																																																																																																																																																																						
	35	1485	60.9	0.88	94.3	5.5	2.1	2.1			LS 315 MR	118	2975	198	0.92	93.3	8.5	2.5	3.3	3.27	845	40	1485	69.6	0.88	94.3	5.5	2.1	2.1																																																																																																																																																																																																																																																																																																																																																			
LS 315 MR	118	2975	198	0.92	93.3	8.5	2.5	3.3	3.27	845																																																																																																																																																																																																																																																																																																																																																																						
	40	1485	69.6	0.88	94.3	5.5	2.1	2.1																																																																																																																																																																																																																																																																																																																																																																								

The top line for each type corresponds to the highest rated speed.

Note: - For mains supplies with different voltages, see section D2.2.4.
- Applies to all the two-speed motor tables.

3-phase TEFV induction motors LS aluminium alloy frame Electrical characteristics

E2 - Selection data: two-speed

4-6 poles
1500-1000 min⁻¹

IP 55 - Cl. F - S1
Centrifugal applications
2 separate windings*

MAINS SUPPLY 400 V 50 Hz

Type	Rated power at 50 Hz	Rated speed	Rated current	Power factor	Efficiency	Starting current / Rated current	Starting torque / Rated torque	Maximum torque / Rated torque	Moment of inertia	Weight																																																																																																																																																																																																																																																																																																																																																																																																																															
	P_N kW	N_N min ⁻¹	$I_N(400 V)$ A	$\cos \varphi$	η %	I_D/I_N	M_D/M_N	M_M/M_N	J kg.m ²	IM B3 kg																																																																																																																																																																																																																																																																																																																																																																																																																															
LS 71 L	0.25	1430	0.75	0.78	66	3.9	1.4	1.9	0.0011	8.3																																																																																																																																																																																																																																																																																																																																																																																																																															
	0.09	960	0.55	0.64	40	2.3	1.2	1.9			LS 80 L	0.7	1435	2.1	0.73	67	4.5	1.8	2	0.0024	11.5	0.2	945	1.05	0.72	40	2.5	1.1	1.4	LS 90 S	0.85	1430	2.2	0.78	70	5.5	2	2.4	0.0032	14	0.25	930	0.85	0.79	55	3.5	1.2	1.6	LS 90 L	1.4	1425	3.5	0.79	73	6	2.2	2.6	0.0049	17	0.5	925	1.4	0.80	61	3.6	1.3	1.7	LS 100 L	2.4	1425	5.9	0.80	73.9	6	2.4	2.6	0.0071	25	0.75	940	2.1	0.71	66.8	4.3	2.2	2.3	LS 112 MG	3.4	1460	8.7	0.72	78	6.9	2.4	2.7	0.015	30	1.1	965	3.4	0.75	64	4	1.3	2	LS 132 SM	4	1452	8.1	0.86	82.8	6.3	2.1	2.1	0.025	44	1.2	972	3	0.76	76.9	4.6	2	1.7	LS 132 M	6.3	1459	13.2	0.82	83.9	7.4	2.8	2.7	0.033	55	1.9	974	4.6	0.77	76.9	5.5	2.3	1.9	LS 160 M	9	1465	18.8	0.81	85.2	7	2.1	3.1	0.057	75	3	975	7.8	0.74	74.9	5.2	1.6	2.4	LS 160 M	11	1465	22.6	0.82	85.7	7.4	2.1	3.1	0.068	85	3.7	975	9.3	0.74	77.8	5.5	1.7	2.6	LS 160 L	13	1465	25.6	0.84	87.3	7.8	2.3	3.2	0.085	97	4.3	970	10.5	0.75	78.6	5.5	1.7	2.5	LS 160 LU	15	1465	29.3	0.84	87.9	7.5	2.4	3	0.096	109	5	970	12.1	0.76	78.8	5.1	1.8	2.2	LS 180 L	18.5	1460	34.1	0.88	89	5.5	2	2.3	0.123	136	6.5	980	14.8	0.78	81	5	2	2.2	LS 180 LU	22	1470	41.5	0.86	89	6.8	2.6	2.7	0.147	155	7.5	980	16.6	0.8	81.5	4.8	2	2	LS 200 L	25	1475	46.9	0.85	90.5	6.4	2.2	2.5	0.24	200	8.5	985	19.3	0.77	82.5	4.8	2	2	LS 200 LU	30	1475	56	0.85	91	6	2.2	2.5	0.27	228	9	985	20.8	0.74	84.5	5.3	2.4	2.3	LS 225 SR	34	1475	63.8	0.84	91.6	6.3	2.3	2.6	0.29	235	11	985	25.9	0.73	84	5.1	2.3	2.2	LS 250 ME	42	1480	77.7	0.85	91.8	6.5	2.5	2.7	0.83	380	14	985	31.8	0.73	87	5.1	2.7	2.4	LS 250 MF	52	1480	96	0.85	92	6.5	2.5	2.7	1.03	450	19	985	43.2	0.73	87	5.1	2.7	2.4	LS 280 SK	75	1485	134.6	0.86	93.5	7.7	2.1	2.7	1.89	610	28	985	56.3	0.8	89.7	6.6	2.9	2.4	LS 280 MK	90	1485	161.2	0.86	93.7	7.7	2.3	2.9	2.23	665	33	985	66.2	0.8	90	6.9	2.9	2.4	LS 315 SP	110	1485	198.9	0.85	93.9	8	2.7	2.9	2.64	750	37	985	74.1	0.8	90.1	6.9	2.9	2.4	LS 315 MR	132	1485	244.2	0.83	94	9.2	3.1	3.3	3.27	860	44	985	88	0.8	90.2
LS 80 L	0.7	1435	2.1	0.73	67	4.5	1.8	2	0.0024	11.5																																																																																																																																																																																																																																																																																																																																																																																																																															
	0.2	945	1.05	0.72	40	2.5	1.1	1.4			LS 90 S	0.85	1430	2.2	0.78	70	5.5	2	2.4	0.0032	14	0.25	930	0.85	0.79	55	3.5	1.2	1.6	LS 90 L	1.4	1425	3.5	0.79	73	6	2.2	2.6	0.0049	17	0.5	925	1.4	0.80	61	3.6	1.3	1.7	LS 100 L	2.4	1425	5.9	0.80	73.9	6	2.4	2.6	0.0071	25	0.75	940	2.1	0.71	66.8	4.3	2.2	2.3	LS 112 MG	3.4	1460	8.7	0.72	78	6.9	2.4	2.7	0.015	30	1.1	965	3.4	0.75	64	4	1.3	2	LS 132 SM	4	1452	8.1	0.86	82.8	6.3	2.1	2.1	0.025	44	1.2	972	3	0.76	76.9	4.6	2	1.7	LS 132 M	6.3	1459	13.2	0.82	83.9	7.4	2.8	2.7	0.033	55	1.9	974	4.6	0.77	76.9	5.5	2.3	1.9	LS 160 M	9	1465	18.8	0.81	85.2	7	2.1	3.1	0.057	75	3	975	7.8	0.74	74.9	5.2	1.6	2.4	LS 160 M	11	1465	22.6	0.82	85.7	7.4	2.1	3.1	0.068	85	3.7	975	9.3	0.74	77.8	5.5	1.7	2.6	LS 160 L	13	1465	25.6	0.84	87.3	7.8	2.3	3.2	0.085	97	4.3	970	10.5	0.75	78.6	5.5	1.7	2.5	LS 160 LU	15	1465	29.3	0.84	87.9	7.5	2.4	3	0.096	109	5	970	12.1	0.76	78.8	5.1	1.8	2.2	LS 180 L	18.5	1460	34.1	0.88	89	5.5	2	2.3	0.123	136	6.5	980	14.8	0.78	81	5	2	2.2	LS 180 LU	22	1470	41.5	0.86	89	6.8	2.6	2.7	0.147	155	7.5	980	16.6	0.8	81.5	4.8	2	2	LS 200 L	25	1475	46.9	0.85	90.5	6.4	2.2	2.5	0.24	200	8.5	985	19.3	0.77	82.5	4.8	2	2	LS 200 LU	30	1475	56	0.85	91	6	2.2	2.5	0.27	228	9	985	20.8	0.74	84.5	5.3	2.4	2.3	LS 225 SR	34	1475	63.8	0.84	91.6	6.3	2.3	2.6	0.29	235	11	985	25.9	0.73	84	5.1	2.3	2.2	LS 250 ME	42	1480	77.7	0.85	91.8	6.5	2.5	2.7	0.83	380	14	985	31.8	0.73	87	5.1	2.7	2.4	LS 250 MF	52	1480	96	0.85	92	6.5	2.5	2.7	1.03	450	19	985	43.2	0.73	87	5.1	2.7	2.4	LS 280 SK	75	1485	134.6	0.86	93.5	7.7	2.1	2.7	1.89	610	28	985	56.3	0.8	89.7	6.6	2.9	2.4	LS 280 MK	90	1485	161.2	0.86	93.7	7.7	2.3	2.9	2.23	665	33	985	66.2	0.8	90	6.9	2.9	2.4	LS 315 SP	110	1485	198.9	0.85	93.9	8	2.7	2.9	2.64	750	37	985	74.1	0.8	90.1	6.9	2.9	2.4	LS 315 MR	132	1485	244.2	0.83	94	9.2	3.1	3.3	3.27	860	44	985	88	0.8	90.2	7.1	2.9	2.4																
LS 90 S	0.85	1430	2.2	0.78	70	5.5	2	2.4	0.0032	14																																																																																																																																																																																																																																																																																																																																																																																																																															
	0.25	930	0.85	0.79	55	3.5	1.2	1.6			LS 90 L	1.4	1425	3.5	0.79	73	6	2.2	2.6	0.0049	17	0.5	925	1.4	0.80	61	3.6	1.3	1.7	LS 100 L	2.4	1425	5.9	0.80	73.9	6	2.4	2.6	0.0071	25	0.75	940	2.1	0.71	66.8	4.3	2.2	2.3	LS 112 MG	3.4	1460	8.7	0.72	78	6.9	2.4	2.7	0.015	30	1.1	965	3.4	0.75	64	4	1.3	2	LS 132 SM	4	1452	8.1	0.86	82.8	6.3	2.1	2.1	0.025	44	1.2	972	3	0.76	76.9	4.6	2	1.7	LS 132 M	6.3	1459	13.2	0.82	83.9	7.4	2.8	2.7	0.033	55	1.9	974	4.6	0.77	76.9	5.5	2.3	1.9	LS 160 M	9	1465	18.8	0.81	85.2	7	2.1	3.1	0.057	75	3	975	7.8	0.74	74.9	5.2	1.6	2.4	LS 160 M	11	1465	22.6	0.82	85.7	7.4	2.1	3.1	0.068	85	3.7	975	9.3	0.74	77.8	5.5	1.7	2.6	LS 160 L	13	1465	25.6	0.84	87.3	7.8	2.3	3.2	0.085	97	4.3	970	10.5	0.75	78.6	5.5	1.7	2.5	LS 160 LU	15	1465	29.3	0.84	87.9	7.5	2.4	3	0.096	109	5	970	12.1	0.76	78.8	5.1	1.8	2.2	LS 180 L	18.5	1460	34.1	0.88	89	5.5	2	2.3	0.123	136	6.5	980	14.8	0.78	81	5	2	2.2	LS 180 LU	22	1470	41.5	0.86	89	6.8	2.6	2.7	0.147	155	7.5	980	16.6	0.8	81.5	4.8	2	2	LS 200 L	25	1475	46.9	0.85	90.5	6.4	2.2	2.5	0.24	200	8.5	985	19.3	0.77	82.5	4.8	2	2	LS 200 LU	30	1475	56	0.85	91	6	2.2	2.5	0.27	228	9	985	20.8	0.74	84.5	5.3	2.4	2.3	LS 225 SR	34	1475	63.8	0.84	91.6	6.3	2.3	2.6	0.29	235	11	985	25.9	0.73	84	5.1	2.3	2.2	LS 250 ME	42	1480	77.7	0.85	91.8	6.5	2.5	2.7	0.83	380	14	985	31.8	0.73	87	5.1	2.7	2.4	LS 250 MF	52	1480	96	0.85	92	6.5	2.5	2.7	1.03	450	19	985	43.2	0.73	87	5.1	2.7	2.4	LS 280 SK	75	1485	134.6	0.86	93.5	7.7	2.1	2.7	1.89	610	28	985	56.3	0.8	89.7	6.6	2.9	2.4	LS 280 MK	90	1485	161.2	0.86	93.7	7.7	2.3	2.9	2.23	665	33	985	66.2	0.8	90	6.9	2.9	2.4	LS 315 SP	110	1485	198.9	0.85	93.9	8	2.7	2.9	2.64	750	37	985	74.1	0.8	90.1	6.9	2.9	2.4	LS 315 MR	132	1485	244.2	0.83	94	9.2	3.1	3.3	3.27	860	44	985	88	0.8	90.2	7.1	2.9	2.4																																			
LS 90 L	1.4	1425	3.5	0.79	73	6	2.2	2.6	0.0049	17																																																																																																																																																																																																																																																																																																																																																																																																																															
	0.5	925	1.4	0.80	61	3.6	1.3	1.7			LS 100 L	2.4	1425	5.9	0.80	73.9	6	2.4	2.6	0.0071	25	0.75	940	2.1	0.71	66.8	4.3	2.2	2.3	LS 112 MG	3.4	1460	8.7	0.72	78	6.9	2.4	2.7	0.015	30	1.1	965	3.4	0.75	64	4	1.3	2	LS 132 SM	4	1452	8.1	0.86	82.8	6.3	2.1	2.1	0.025	44	1.2	972	3	0.76	76.9	4.6	2	1.7	LS 132 M	6.3	1459	13.2	0.82	83.9	7.4	2.8	2.7	0.033	55	1.9	974	4.6	0.77	76.9	5.5	2.3	1.9	LS 160 M	9	1465	18.8	0.81	85.2	7	2.1	3.1	0.057	75	3	975	7.8	0.74	74.9	5.2	1.6	2.4	LS 160 M	11	1465	22.6	0.82	85.7	7.4	2.1	3.1	0.068	85	3.7	975	9.3	0.74	77.8	5.5	1.7	2.6	LS 160 L	13	1465	25.6	0.84	87.3	7.8	2.3	3.2	0.085	97	4.3	970	10.5	0.75	78.6	5.5	1.7	2.5	LS 160 LU	15	1465	29.3	0.84	87.9	7.5	2.4	3	0.096	109	5	970	12.1	0.76	78.8	5.1	1.8	2.2	LS 180 L	18.5	1460	34.1	0.88	89	5.5	2	2.3	0.123	136	6.5	980	14.8	0.78	81	5	2	2.2	LS 180 LU	22	1470	41.5	0.86	89	6.8	2.6	2.7	0.147	155	7.5	980	16.6	0.8	81.5	4.8	2	2	LS 200 L	25	1475	46.9	0.85	90.5	6.4	2.2	2.5	0.24	200	8.5	985	19.3	0.77	82.5	4.8	2	2	LS 200 LU	30	1475	56	0.85	91	6	2.2	2.5	0.27	228	9	985	20.8	0.74	84.5	5.3	2.4	2.3	LS 225 SR	34	1475	63.8	0.84	91.6	6.3	2.3	2.6	0.29	235	11	985	25.9	0.73	84	5.1	2.3	2.2	LS 250 ME	42	1480	77.7	0.85	91.8	6.5	2.5	2.7	0.83	380	14	985	31.8	0.73	87	5.1	2.7	2.4	LS 250 MF	52	1480	96	0.85	92	6.5	2.5	2.7	1.03	450	19	985	43.2	0.73	87	5.1	2.7	2.4	LS 280 SK	75	1485	134.6	0.86	93.5	7.7	2.1	2.7	1.89	610	28	985	56.3	0.8	89.7	6.6	2.9	2.4	LS 280 MK	90	1485	161.2	0.86	93.7	7.7	2.3	2.9	2.23	665	33	985	66.2	0.8	90	6.9	2.9	2.4	LS 315 SP	110	1485	198.9	0.85	93.9	8	2.7	2.9	2.64	750	37	985	74.1	0.8	90.1	6.9	2.9	2.4	LS 315 MR	132	1485	244.2	0.83	94	9.2	3.1	3.3	3.27	860	44	985	88	0.8	90.2	7.1	2.9	2.4																																																						
LS 100 L	2.4	1425	5.9	0.80	73.9	6	2.4	2.6	0.0071	25																																																																																																																																																																																																																																																																																																																																																																																																																															
	0.75	940	2.1	0.71	66.8	4.3	2.2	2.3			LS 112 MG	3.4	1460	8.7	0.72	78	6.9	2.4	2.7	0.015	30	1.1	965	3.4	0.75	64	4	1.3	2	LS 132 SM	4	1452	8.1	0.86	82.8	6.3	2.1	2.1	0.025	44	1.2	972	3	0.76	76.9	4.6	2	1.7	LS 132 M	6.3	1459	13.2	0.82	83.9	7.4	2.8	2.7	0.033	55	1.9	974	4.6	0.77	76.9	5.5	2.3	1.9	LS 160 M	9	1465	18.8	0.81	85.2	7	2.1	3.1	0.057	75	3	975	7.8	0.74	74.9	5.2	1.6	2.4	LS 160 M	11	1465	22.6	0.82	85.7	7.4	2.1	3.1	0.068	85	3.7	975	9.3	0.74	77.8	5.5	1.7	2.6	LS 160 L	13	1465	25.6	0.84	87.3	7.8	2.3	3.2	0.085	97	4.3	970	10.5	0.75	78.6	5.5	1.7	2.5	LS 160 LU	15	1465	29.3	0.84	87.9	7.5	2.4	3	0.096	109	5	970	12.1	0.76	78.8	5.1	1.8	2.2	LS 180 L	18.5	1460	34.1	0.88	89	5.5	2	2.3	0.123	136	6.5	980	14.8	0.78	81	5	2	2.2	LS 180 LU	22	1470	41.5	0.86	89	6.8	2.6	2.7	0.147	155	7.5	980	16.6	0.8	81.5	4.8	2	2	LS 200 L	25	1475	46.9	0.85	90.5	6.4	2.2	2.5	0.24	200	8.5	985	19.3	0.77	82.5	4.8	2	2	LS 200 LU	30	1475	56	0.85	91	6	2.2	2.5	0.27	228	9	985	20.8	0.74	84.5	5.3	2.4	2.3	LS 225 SR	34	1475	63.8	0.84	91.6	6.3	2.3	2.6	0.29	235	11	985	25.9	0.73	84	5.1	2.3	2.2	LS 250 ME	42	1480	77.7	0.85	91.8	6.5	2.5	2.7	0.83	380	14	985	31.8	0.73	87	5.1	2.7	2.4	LS 250 MF	52	1480	96	0.85	92	6.5	2.5	2.7	1.03	450	19	985	43.2	0.73	87	5.1	2.7	2.4	LS 280 SK	75	1485	134.6	0.86	93.5	7.7	2.1	2.7	1.89	610	28	985	56.3	0.8	89.7	6.6	2.9	2.4	LS 280 MK	90	1485	161.2	0.86	93.7	7.7	2.3	2.9	2.23	665	33	985	66.2	0.8	90	6.9	2.9	2.4	LS 315 SP	110	1485	198.9	0.85	93.9	8	2.7	2.9	2.64	750	37	985	74.1	0.8	90.1	6.9	2.9	2.4	LS 315 MR	132	1485	244.2	0.83	94	9.2	3.1	3.3	3.27	860	44	985	88	0.8	90.2	7.1	2.9	2.4																																																																									
LS 112 MG	3.4	1460	8.7	0.72	78	6.9	2.4	2.7	0.015	30																																																																																																																																																																																																																																																																																																																																																																																																																															
	1.1	965	3.4	0.75	64	4	1.3	2			LS 132 SM	4	1452	8.1	0.86	82.8	6.3	2.1	2.1	0.025	44	1.2	972	3	0.76	76.9	4.6	2	1.7	LS 132 M	6.3	1459	13.2	0.82	83.9	7.4	2.8	2.7	0.033	55	1.9	974	4.6	0.77	76.9	5.5	2.3	1.9	LS 160 M	9	1465	18.8	0.81	85.2	7	2.1	3.1	0.057	75	3	975	7.8	0.74	74.9	5.2	1.6	2.4	LS 160 M	11	1465	22.6	0.82	85.7	7.4	2.1	3.1	0.068	85	3.7	975	9.3	0.74	77.8	5.5	1.7	2.6	LS 160 L	13	1465	25.6	0.84	87.3	7.8	2.3	3.2	0.085	97	4.3	970	10.5	0.75	78.6	5.5	1.7	2.5	LS 160 LU	15	1465	29.3	0.84	87.9	7.5	2.4	3	0.096	109	5	970	12.1	0.76	78.8	5.1	1.8	2.2	LS 180 L	18.5	1460	34.1	0.88	89	5.5	2	2.3	0.123	136	6.5	980	14.8	0.78	81	5	2	2.2	LS 180 LU	22	1470	41.5	0.86	89	6.8	2.6	2.7	0.147	155	7.5	980	16.6	0.8	81.5	4.8	2	2	LS 200 L	25	1475	46.9	0.85	90.5	6.4	2.2	2.5	0.24	200	8.5	985	19.3	0.77	82.5	4.8	2	2	LS 200 LU	30	1475	56	0.85	91	6	2.2	2.5	0.27	228	9	985	20.8	0.74	84.5	5.3	2.4	2.3	LS 225 SR	34	1475	63.8	0.84	91.6	6.3	2.3	2.6	0.29	235	11	985	25.9	0.73	84	5.1	2.3	2.2	LS 250 ME	42	1480	77.7	0.85	91.8	6.5	2.5	2.7	0.83	380	14	985	31.8	0.73	87	5.1	2.7	2.4	LS 250 MF	52	1480	96	0.85	92	6.5	2.5	2.7	1.03	450	19	985	43.2	0.73	87	5.1	2.7	2.4	LS 280 SK	75	1485	134.6	0.86	93.5	7.7	2.1	2.7	1.89	610	28	985	56.3	0.8	89.7	6.6	2.9	2.4	LS 280 MK	90	1485	161.2	0.86	93.7	7.7	2.3	2.9	2.23	665	33	985	66.2	0.8	90	6.9	2.9	2.4	LS 315 SP	110	1485	198.9	0.85	93.9	8	2.7	2.9	2.64	750	37	985	74.1	0.8	90.1	6.9	2.9	2.4	LS 315 MR	132	1485	244.2	0.83	94	9.2	3.1	3.3	3.27	860	44	985	88	0.8	90.2	7.1	2.9	2.4																																																																																												
LS 132 SM	4	1452	8.1	0.86	82.8	6.3	2.1	2.1	0.025	44																																																																																																																																																																																																																																																																																																																																																																																																																															
	1.2	972	3	0.76	76.9	4.6	2	1.7			LS 132 M	6.3	1459	13.2	0.82	83.9	7.4	2.8	2.7	0.033	55	1.9	974	4.6	0.77	76.9	5.5	2.3	1.9	LS 160 M	9	1465	18.8	0.81	85.2	7	2.1	3.1	0.057	75	3	975	7.8	0.74	74.9	5.2	1.6	2.4	LS 160 M	11	1465	22.6	0.82	85.7	7.4	2.1	3.1	0.068	85	3.7	975	9.3	0.74	77.8	5.5	1.7	2.6	LS 160 L	13	1465	25.6	0.84	87.3	7.8	2.3	3.2	0.085	97	4.3	970	10.5	0.75	78.6	5.5	1.7	2.5	LS 160 LU	15	1465	29.3	0.84	87.9	7.5	2.4	3	0.096	109	5	970	12.1	0.76	78.8	5.1	1.8	2.2	LS 180 L	18.5	1460	34.1	0.88	89	5.5	2	2.3	0.123	136	6.5	980	14.8	0.78	81	5	2	2.2	LS 180 LU	22	1470	41.5	0.86	89	6.8	2.6	2.7	0.147	155	7.5	980	16.6	0.8	81.5	4.8	2	2	LS 200 L	25	1475	46.9	0.85	90.5	6.4	2.2	2.5	0.24	200	8.5	985	19.3	0.77	82.5	4.8	2	2	LS 200 LU	30	1475	56	0.85	91	6	2.2	2.5	0.27	228	9	985	20.8	0.74	84.5	5.3	2.4	2.3	LS 225 SR	34	1475	63.8	0.84	91.6	6.3	2.3	2.6	0.29	235	11	985	25.9	0.73	84	5.1	2.3	2.2	LS 250 ME	42	1480	77.7	0.85	91.8	6.5	2.5	2.7	0.83	380	14	985	31.8	0.73	87	5.1	2.7	2.4	LS 250 MF	52	1480	96	0.85	92	6.5	2.5	2.7	1.03	450	19	985	43.2	0.73	87	5.1	2.7	2.4	LS 280 SK	75	1485	134.6	0.86	93.5	7.7	2.1	2.7	1.89	610	28	985	56.3	0.8	89.7	6.6	2.9	2.4	LS 280 MK	90	1485	161.2	0.86	93.7	7.7	2.3	2.9	2.23	665	33	985	66.2	0.8	90	6.9	2.9	2.4	LS 315 SP	110	1485	198.9	0.85	93.9	8	2.7	2.9	2.64	750	37	985	74.1	0.8	90.1	6.9	2.9	2.4	LS 315 MR	132	1485	244.2	0.83	94	9.2	3.1	3.3	3.27	860	44	985	88	0.8	90.2	7.1	2.9	2.4																																																																																																															
LS 132 M	6.3	1459	13.2	0.82	83.9	7.4	2.8	2.7	0.033	55																																																																																																																																																																																																																																																																																																																																																																																																																															
	1.9	974	4.6	0.77	76.9	5.5	2.3	1.9			LS 160 M	9	1465	18.8	0.81	85.2	7	2.1	3.1	0.057	75	3	975	7.8	0.74	74.9	5.2	1.6	2.4	LS 160 M	11	1465	22.6	0.82	85.7	7.4	2.1	3.1	0.068	85	3.7	975	9.3	0.74	77.8	5.5	1.7	2.6	LS 160 L	13	1465	25.6	0.84	87.3	7.8	2.3	3.2	0.085	97	4.3	970	10.5	0.75	78.6	5.5	1.7	2.5	LS 160 LU	15	1465	29.3	0.84	87.9	7.5	2.4	3	0.096	109	5	970	12.1	0.76	78.8	5.1	1.8	2.2	LS 180 L	18.5	1460	34.1	0.88	89	5.5	2	2.3	0.123	136	6.5	980	14.8	0.78	81	5	2	2.2	LS 180 LU	22	1470	41.5	0.86	89	6.8	2.6	2.7	0.147	155	7.5	980	16.6	0.8	81.5	4.8	2	2	LS 200 L	25	1475	46.9	0.85	90.5	6.4	2.2	2.5	0.24	200	8.5	985	19.3	0.77	82.5	4.8	2	2	LS 200 LU	30	1475	56	0.85	91	6	2.2	2.5	0.27	228	9	985	20.8	0.74	84.5	5.3	2.4	2.3	LS 225 SR	34	1475	63.8	0.84	91.6	6.3	2.3	2.6	0.29	235	11	985	25.9	0.73	84	5.1	2.3	2.2	LS 250 ME	42	1480	77.7	0.85	91.8	6.5	2.5	2.7	0.83	380	14	985	31.8	0.73	87	5.1	2.7	2.4	LS 250 MF	52	1480	96	0.85	92	6.5	2.5	2.7	1.03	450	19	985	43.2	0.73	87	5.1	2.7	2.4	LS 280 SK	75	1485	134.6	0.86	93.5	7.7	2.1	2.7	1.89	610	28	985	56.3	0.8	89.7	6.6	2.9	2.4	LS 280 MK	90	1485	161.2	0.86	93.7	7.7	2.3	2.9	2.23	665	33	985	66.2	0.8	90	6.9	2.9	2.4	LS 315 SP	110	1485	198.9	0.85	93.9	8	2.7	2.9	2.64	750	37	985	74.1	0.8	90.1	6.9	2.9	2.4	LS 315 MR	132	1485	244.2	0.83	94	9.2	3.1	3.3	3.27	860	44	985	88	0.8	90.2	7.1	2.9	2.4																																																																																																																																		
LS 160 M	9	1465	18.8	0.81	85.2	7	2.1	3.1	0.057	75																																																																																																																																																																																																																																																																																																																																																																																																																															
	3	975	7.8	0.74	74.9	5.2	1.6	2.4			LS 160 M	11	1465	22.6	0.82	85.7	7.4	2.1	3.1	0.068	85	3.7	975	9.3	0.74	77.8	5.5	1.7	2.6	LS 160 L	13	1465	25.6	0.84	87.3	7.8	2.3	3.2	0.085	97	4.3	970	10.5	0.75	78.6	5.5	1.7	2.5	LS 160 LU	15	1465	29.3	0.84	87.9	7.5	2.4	3	0.096	109	5	970	12.1	0.76	78.8	5.1	1.8	2.2	LS 180 L	18.5	1460	34.1	0.88	89	5.5	2	2.3	0.123	136	6.5	980	14.8	0.78	81	5	2	2.2	LS 180 LU	22	1470	41.5	0.86	89	6.8	2.6	2.7	0.147	155	7.5	980	16.6	0.8	81.5	4.8	2	2	LS 200 L	25	1475	46.9	0.85	90.5	6.4	2.2	2.5	0.24	200	8.5	985	19.3	0.77	82.5	4.8	2	2	LS 200 LU	30	1475	56	0.85	91	6	2.2	2.5	0.27	228	9	985	20.8	0.74	84.5	5.3	2.4	2.3	LS 225 SR	34	1475	63.8	0.84	91.6	6.3	2.3	2.6	0.29	235	11	985	25.9	0.73	84	5.1	2.3	2.2	LS 250 ME	42	1480	77.7	0.85	91.8	6.5	2.5	2.7	0.83	380	14	985	31.8	0.73	87	5.1	2.7	2.4	LS 250 MF	52	1480	96	0.85	92	6.5	2.5	2.7	1.03	450	19	985	43.2	0.73	87	5.1	2.7	2.4	LS 280 SK	75	1485	134.6	0.86	93.5	7.7	2.1	2.7	1.89	610	28	985	56.3	0.8	89.7	6.6	2.9	2.4	LS 280 MK	90	1485	161.2	0.86	93.7	7.7	2.3	2.9	2.23	665	33	985	66.2	0.8	90	6.9	2.9	2.4	LS 315 SP	110	1485	198.9	0.85	93.9	8	2.7	2.9	2.64	750	37	985	74.1	0.8	90.1	6.9	2.9	2.4	LS 315 MR	132	1485	244.2	0.83	94	9.2	3.1	3.3	3.27	860	44	985	88	0.8	90.2	7.1	2.9	2.4																																																																																																																																																					
LS 160 M	11	1465	22.6	0.82	85.7	7.4	2.1	3.1	0.068	85																																																																																																																																																																																																																																																																																																																																																																																																																															
	3.7	975	9.3	0.74	77.8	5.5	1.7	2.6			LS 160 L	13	1465	25.6	0.84	87.3	7.8	2.3	3.2	0.085	97	4.3	970	10.5	0.75	78.6	5.5	1.7	2.5	LS 160 LU	15	1465	29.3	0.84	87.9	7.5	2.4	3	0.096	109	5	970	12.1	0.76	78.8	5.1	1.8	2.2	LS 180 L	18.5	1460	34.1	0.88	89	5.5	2	2.3	0.123	136	6.5	980	14.8	0.78	81	5	2	2.2	LS 180 LU	22	1470	41.5	0.86	89	6.8	2.6	2.7	0.147	155	7.5	980	16.6	0.8	81.5	4.8	2	2	LS 200 L	25	1475	46.9	0.85	90.5	6.4	2.2	2.5	0.24	200	8.5	985	19.3	0.77	82.5	4.8	2	2	LS 200 LU	30	1475	56	0.85	91	6	2.2	2.5	0.27	228	9	985	20.8	0.74	84.5	5.3	2.4	2.3	LS 225 SR	34	1475	63.8	0.84	91.6	6.3	2.3	2.6	0.29	235	11	985	25.9	0.73	84	5.1	2.3	2.2	LS 250 ME	42	1480	77.7	0.85	91.8	6.5	2.5	2.7	0.83	380	14	985	31.8	0.73	87	5.1	2.7	2.4	LS 250 MF	52	1480	96	0.85	92	6.5	2.5	2.7	1.03	450	19	985	43.2	0.73	87	5.1	2.7	2.4	LS 280 SK	75	1485	134.6	0.86	93.5	7.7	2.1	2.7	1.89	610	28	985	56.3	0.8	89.7	6.6	2.9	2.4	LS 280 MK	90	1485	161.2	0.86	93.7	7.7	2.3	2.9	2.23	665	33	985	66.2	0.8	90	6.9	2.9	2.4	LS 315 SP	110	1485	198.9	0.85	93.9	8	2.7	2.9	2.64	750	37	985	74.1	0.8	90.1	6.9	2.9	2.4	LS 315 MR	132	1485	244.2	0.83	94	9.2	3.1	3.3	3.27	860	44	985	88	0.8	90.2	7.1	2.9	2.4																																																																																																																																																																								
LS 160 L	13	1465	25.6	0.84	87.3	7.8	2.3	3.2	0.085	97																																																																																																																																																																																																																																																																																																																																																																																																																															
	4.3	970	10.5	0.75	78.6	5.5	1.7	2.5			LS 160 LU	15	1465	29.3	0.84	87.9	7.5	2.4	3	0.096	109	5	970	12.1	0.76	78.8	5.1	1.8	2.2	LS 180 L	18.5	1460	34.1	0.88	89	5.5	2	2.3	0.123	136	6.5	980	14.8	0.78	81	5	2	2.2	LS 180 LU	22	1470	41.5	0.86	89	6.8	2.6	2.7	0.147	155	7.5	980	16.6	0.8	81.5	4.8	2	2	LS 200 L	25	1475	46.9	0.85	90.5	6.4	2.2	2.5	0.24	200	8.5	985	19.3	0.77	82.5	4.8	2	2	LS 200 LU	30	1475	56	0.85	91	6	2.2	2.5	0.27	228	9	985	20.8	0.74	84.5	5.3	2.4	2.3	LS 225 SR	34	1475	63.8	0.84	91.6	6.3	2.3	2.6	0.29	235	11	985	25.9	0.73	84	5.1	2.3	2.2	LS 250 ME	42	1480	77.7	0.85	91.8	6.5	2.5	2.7	0.83	380	14	985	31.8	0.73	87	5.1	2.7	2.4	LS 250 MF	52	1480	96	0.85	92	6.5	2.5	2.7	1.03	450	19	985	43.2	0.73	87	5.1	2.7	2.4	LS 280 SK	75	1485	134.6	0.86	93.5	7.7	2.1	2.7	1.89	610	28	985	56.3	0.8	89.7	6.6	2.9	2.4	LS 280 MK	90	1485	161.2	0.86	93.7	7.7	2.3	2.9	2.23	665	33	985	66.2	0.8	90	6.9	2.9	2.4	LS 315 SP	110	1485	198.9	0.85	93.9	8	2.7	2.9	2.64	750	37	985	74.1	0.8	90.1	6.9	2.9	2.4	LS 315 MR	132	1485	244.2	0.83	94	9.2	3.1	3.3	3.27	860	44	985	88	0.8	90.2	7.1	2.9	2.4																																																																																																																																																																																											
LS 160 LU	15	1465	29.3	0.84	87.9	7.5	2.4	3	0.096	109																																																																																																																																																																																																																																																																																																																																																																																																																															
	5	970	12.1	0.76	78.8	5.1	1.8	2.2			LS 180 L	18.5	1460	34.1	0.88	89	5.5	2	2.3	0.123	136	6.5	980	14.8	0.78	81	5	2	2.2	LS 180 LU	22	1470	41.5	0.86	89	6.8	2.6	2.7	0.147	155	7.5	980	16.6	0.8	81.5	4.8	2	2	LS 200 L	25	1475	46.9	0.85	90.5	6.4	2.2	2.5	0.24	200	8.5	985	19.3	0.77	82.5	4.8	2	2	LS 200 LU	30	1475	56	0.85	91	6	2.2	2.5	0.27	228	9	985	20.8	0.74	84.5	5.3	2.4	2.3	LS 225 SR	34	1475	63.8	0.84	91.6	6.3	2.3	2.6	0.29	235	11	985	25.9	0.73	84	5.1	2.3	2.2	LS 250 ME	42	1480	77.7	0.85	91.8	6.5	2.5	2.7	0.83	380	14	985	31.8	0.73	87	5.1	2.7	2.4	LS 250 MF	52	1480	96	0.85	92	6.5	2.5	2.7	1.03	450	19	985	43.2	0.73	87	5.1	2.7	2.4	LS 280 SK	75	1485	134.6	0.86	93.5	7.7	2.1	2.7	1.89	610	28	985	56.3	0.8	89.7	6.6	2.9	2.4	LS 280 MK	90	1485	161.2	0.86	93.7	7.7	2.3	2.9	2.23	665	33	985	66.2	0.8	90	6.9	2.9	2.4	LS 315 SP	110	1485	198.9	0.85	93.9	8	2.7	2.9	2.64	750	37	985	74.1	0.8	90.1	6.9	2.9	2.4	LS 315 MR	132	1485	244.2	0.83	94	9.2	3.1	3.3	3.27	860	44	985	88	0.8	90.2	7.1	2.9	2.4																																																																																																																																																																																																														
LS 180 L	18.5	1460	34.1	0.88	89	5.5	2	2.3	0.123	136																																																																																																																																																																																																																																																																																																																																																																																																																															
	6.5	980	14.8	0.78	81	5	2	2.2			LS 180 LU	22	1470	41.5	0.86	89	6.8	2.6	2.7	0.147	155	7.5	980	16.6	0.8	81.5	4.8	2	2	LS 200 L	25	1475	46.9	0.85	90.5	6.4	2.2	2.5	0.24	200	8.5	985	19.3	0.77	82.5	4.8	2	2	LS 200 LU	30	1475	56	0.85	91	6	2.2	2.5	0.27	228	9	985	20.8	0.74	84.5	5.3	2.4	2.3	LS 225 SR	34	1475	63.8	0.84	91.6	6.3	2.3	2.6	0.29	235	11	985	25.9	0.73	84	5.1	2.3	2.2	LS 250 ME	42	1480	77.7	0.85	91.8	6.5	2.5	2.7	0.83	380	14	985	31.8	0.73	87	5.1	2.7	2.4	LS 250 MF	52	1480	96	0.85	92	6.5	2.5	2.7	1.03	450	19	985	43.2	0.73	87	5.1	2.7	2.4	LS 280 SK	75	1485	134.6	0.86	93.5	7.7	2.1	2.7	1.89	610	28	985	56.3	0.8	89.7	6.6	2.9	2.4	LS 280 MK	90	1485	161.2	0.86	93.7	7.7	2.3	2.9	2.23	665	33	985	66.2	0.8	90	6.9	2.9	2.4	LS 315 SP	110	1485	198.9	0.85	93.9	8	2.7	2.9	2.64	750	37	985	74.1	0.8	90.1	6.9	2.9	2.4	LS 315 MR	132	1485	244.2	0.83	94	9.2	3.1	3.3	3.27	860	44	985	88	0.8	90.2	7.1	2.9	2.4																																																																																																																																																																																																																																	
LS 180 LU	22	1470	41.5	0.86	89	6.8	2.6	2.7	0.147	155																																																																																																																																																																																																																																																																																																																																																																																																																															
	7.5	980	16.6	0.8	81.5	4.8	2	2			LS 200 L	25	1475	46.9	0.85	90.5	6.4	2.2	2.5	0.24	200	8.5	985	19.3	0.77	82.5	4.8	2	2	LS 200 LU	30	1475	56	0.85	91	6	2.2	2.5	0.27	228	9	985	20.8	0.74	84.5	5.3	2.4	2.3	LS 225 SR	34	1475	63.8	0.84	91.6	6.3	2.3	2.6	0.29	235	11	985	25.9	0.73	84	5.1	2.3	2.2	LS 250 ME	42	1480	77.7	0.85	91.8	6.5	2.5	2.7	0.83	380	14	985	31.8	0.73	87	5.1	2.7	2.4	LS 250 MF	52	1480	96	0.85	92	6.5	2.5	2.7	1.03	450	19	985	43.2	0.73	87	5.1	2.7	2.4	LS 280 SK	75	1485	134.6	0.86	93.5	7.7	2.1	2.7	1.89	610	28	985	56.3	0.8	89.7	6.6	2.9	2.4	LS 280 MK	90	1485	161.2	0.86	93.7	7.7	2.3	2.9	2.23	665	33	985	66.2	0.8	90	6.9	2.9	2.4	LS 315 SP	110	1485	198.9	0.85	93.9	8	2.7	2.9	2.64	750	37	985	74.1	0.8	90.1	6.9	2.9	2.4	LS 315 MR	132	1485	244.2	0.83	94	9.2	3.1	3.3	3.27	860	44	985	88	0.8	90.2	7.1	2.9	2.4																																																																																																																																																																																																																																																				
LS 200 L	25	1475	46.9	0.85	90.5	6.4	2.2	2.5	0.24	200																																																																																																																																																																																																																																																																																																																																																																																																																															
	8.5	985	19.3	0.77	82.5	4.8	2	2			LS 200 LU	30	1475	56	0.85	91	6	2.2	2.5	0.27	228	9	985	20.8	0.74	84.5	5.3	2.4	2.3	LS 225 SR	34	1475	63.8	0.84	91.6	6.3	2.3	2.6	0.29	235	11	985	25.9	0.73	84	5.1	2.3	2.2	LS 250 ME	42	1480	77.7	0.85	91.8	6.5	2.5	2.7	0.83	380	14	985	31.8	0.73	87	5.1	2.7	2.4	LS 250 MF	52	1480	96	0.85	92	6.5	2.5	2.7	1.03	450	19	985	43.2	0.73	87	5.1	2.7	2.4	LS 280 SK	75	1485	134.6	0.86	93.5	7.7	2.1	2.7	1.89	610	28	985	56.3	0.8	89.7	6.6	2.9	2.4	LS 280 MK	90	1485	161.2	0.86	93.7	7.7	2.3	2.9	2.23	665	33	985	66.2	0.8	90	6.9	2.9	2.4	LS 315 SP	110	1485	198.9	0.85	93.9	8	2.7	2.9	2.64	750	37	985	74.1	0.8	90.1	6.9	2.9	2.4	LS 315 MR	132	1485	244.2	0.83	94	9.2	3.1	3.3	3.27	860	44	985	88	0.8	90.2	7.1	2.9	2.4																																																																																																																																																																																																																																																																							
LS 200 LU	30	1475	56	0.85	91	6	2.2	2.5	0.27	228																																																																																																																																																																																																																																																																																																																																																																																																																															
	9	985	20.8	0.74	84.5	5.3	2.4	2.3			LS 225 SR	34	1475	63.8	0.84	91.6	6.3	2.3	2.6	0.29	235	11	985	25.9	0.73	84	5.1	2.3	2.2	LS 250 ME	42	1480	77.7	0.85	91.8	6.5	2.5	2.7	0.83	380	14	985	31.8	0.73	87	5.1	2.7	2.4	LS 250 MF	52	1480	96	0.85	92	6.5	2.5	2.7	1.03	450	19	985	43.2	0.73	87	5.1	2.7	2.4	LS 280 SK	75	1485	134.6	0.86	93.5	7.7	2.1	2.7	1.89	610	28	985	56.3	0.8	89.7	6.6	2.9	2.4	LS 280 MK	90	1485	161.2	0.86	93.7	7.7	2.3	2.9	2.23	665	33	985	66.2	0.8	90	6.9	2.9	2.4	LS 315 SP	110	1485	198.9	0.85	93.9	8	2.7	2.9	2.64	750	37	985	74.1	0.8	90.1	6.9	2.9	2.4	LS 315 MR	132	1485	244.2	0.83	94	9.2	3.1	3.3	3.27	860	44	985	88	0.8	90.2	7.1	2.9	2.4																																																																																																																																																																																																																																																																																										
LS 225 SR	34	1475	63.8	0.84	91.6	6.3	2.3	2.6	0.29	235																																																																																																																																																																																																																																																																																																																																																																																																																															
	11	985	25.9	0.73	84	5.1	2.3	2.2			LS 250 ME	42	1480	77.7	0.85	91.8	6.5	2.5	2.7	0.83	380	14	985	31.8	0.73	87	5.1	2.7	2.4	LS 250 MF	52	1480	96	0.85	92	6.5	2.5	2.7	1.03	450	19	985	43.2	0.73	87	5.1	2.7	2.4	LS 280 SK	75	1485	134.6	0.86	93.5	7.7	2.1	2.7	1.89	610	28	985	56.3	0.8	89.7	6.6	2.9	2.4	LS 280 MK	90	1485	161.2	0.86	93.7	7.7	2.3	2.9	2.23	665	33	985	66.2	0.8	90	6.9	2.9	2.4	LS 315 SP	110	1485	198.9	0.85	93.9	8	2.7	2.9	2.64	750	37	985	74.1	0.8	90.1	6.9	2.9	2.4	LS 315 MR	132	1485	244.2	0.83	94	9.2	3.1	3.3	3.27	860	44	985	88	0.8	90.2	7.1	2.9	2.4																																																																																																																																																																																																																																																																																																													
LS 250 ME	42	1480	77.7	0.85	91.8	6.5	2.5	2.7	0.83	380																																																																																																																																																																																																																																																																																																																																																																																																																															
	14	985	31.8	0.73	87	5.1	2.7	2.4			LS 250 MF	52	1480	96	0.85	92	6.5	2.5	2.7	1.03	450	19	985	43.2	0.73	87	5.1	2.7	2.4	LS 280 SK	75	1485	134.6	0.86	93.5	7.7	2.1	2.7	1.89	610	28	985	56.3	0.8	89.7	6.6	2.9	2.4	LS 280 MK	90	1485	161.2	0.86	93.7	7.7	2.3	2.9	2.23	665	33	985	66.2	0.8	90	6.9	2.9	2.4	LS 315 SP	110	1485	198.9	0.85	93.9	8	2.7	2.9	2.64	750	37	985	74.1	0.8	90.1	6.9	2.9	2.4	LS 315 MR	132	1485	244.2	0.83	94	9.2	3.1	3.3	3.27	860	44	985	88	0.8	90.2	7.1	2.9	2.4																																																																																																																																																																																																																																																																																																																																
LS 250 MF	52	1480	96	0.85	92	6.5	2.5	2.7	1.03	450																																																																																																																																																																																																																																																																																																																																																																																																																															
	19	985	43.2	0.73	87	5.1	2.7	2.4			LS 280 SK	75	1485	134.6	0.86	93.5	7.7	2.1	2.7	1.89	610	28	985	56.3	0.8	89.7	6.6	2.9	2.4	LS 280 MK	90	1485	161.2	0.86	93.7	7.7	2.3	2.9	2.23	665	33	985	66.2	0.8	90	6.9	2.9	2.4	LS 315 SP	110	1485	198.9	0.85	93.9	8	2.7	2.9	2.64	750	37	985	74.1	0.8	90.1	6.9	2.9	2.4	LS 315 MR	132	1485	244.2	0.83	94	9.2	3.1	3.3	3.27	860	44	985	88	0.8	90.2	7.1	2.9	2.4																																																																																																																																																																																																																																																																																																																																																			
LS 280 SK	75	1485	134.6	0.86	93.5	7.7	2.1	2.7	1.89	610																																																																																																																																																																																																																																																																																																																																																																																																																															
	28	985	56.3	0.8	89.7	6.6	2.9	2.4			LS 280 MK	90	1485	161.2	0.86	93.7	7.7	2.3	2.9	2.23	665	33	985	66.2	0.8	90	6.9	2.9	2.4	LS 315 SP	110	1485	198.9	0.85	93.9	8	2.7	2.9	2.64	750	37	985	74.1	0.8	90.1	6.9	2.9	2.4	LS 315 MR	132	1485	244.2	0.83	94	9.2	3.1	3.3	3.27	860	44	985	88	0.8	90.2	7.1	2.9	2.4																																																																																																																																																																																																																																																																																																																																																																						
LS 280 MK	90	1485	161.2	0.86	93.7	7.7	2.3	2.9	2.23	665																																																																																																																																																																																																																																																																																																																																																																																																																															
	33	985	66.2	0.8	90	6.9	2.9	2.4			LS 315 SP	110	1485	198.9	0.85	93.9	8	2.7	2.9	2.64	750	37	985	74.1	0.8	90.1	6.9	2.9	2.4	LS 315 MR	132	1485	244.2	0.83	94	9.2	3.1	3.3	3.27	860	44	985	88	0.8	90.2	7.1	2.9	2.4																																																																																																																																																																																																																																																																																																																																																																																									
LS 315 SP	110	1485	198.9	0.85	93.9	8	2.7	2.9	2.64	750																																																																																																																																																																																																																																																																																																																																																																																																																															
	37	985	74.1	0.8	90.1	6.9	2.9	2.4			LS 315 MR	132	1485	244.2	0.83	94	9.2	3.1	3.3	3.27	860	44	985	88	0.8	90.2	7.1	2.9	2.4																																																																																																																																																																																																																																																																																																																																																																																																												
LS 315 MR	132	1485	244.2	0.83	94	9.2	3.1	3.3	3.27	860																																																																																																																																																																																																																																																																																																																																																																																																																															
	44	985	88	0.8	90.2	7.1	2.9	2.4																																																																																																																																																																																																																																																																																																																																																																																																																																	

The top line for each type corresponds to the highest rated speed.

* LS 80 to LS 132, 1 winding (PAM), see section E2 page 98.

3-phase TEFV induction motors LS aluminium alloy frame Electrical characteristics

E2 - Selection data: two-speed

**4-6
poles**
1500-1000 min⁻¹

IP 55 - Cl. F - S1
Centrifugal applications
LS 80 L to LS 132 M: 1 winding (PAM)

MAINS SUPPLY 400 V

50 Hz

Type	Rated power at 50 Hz	Rated speed	Rated current	Power factor	Efficiency	Starting current / Rated current	Starting torque / Rated torque	Maximum torque / Rated torque	Moment of inertia	Weight																																																																																																																																		
	P_N kW	N_N min ⁻¹	I_N (400 V) A	$\cos \varphi$	η %	I_D/I_N	M_D/M_N	M_M/M_N	J kg.m ²	IM B3 kg																																																																																																																																		
LS 80 L	0.75	1400	1.8	0.87	67	3.8	1.1	1.5	0.0042	10.9																																																																																																																																		
	0.25	905	0.9	0.88	46	2.1	1	1.2			LS 90 S	1.1	1420	2.6	0.79	77	6	2.5	2.5	0.0039	12.5	0.37	940	1.5	0.63	57	3.3	1.4	1.8	LS 90 L	1.5	1425	3.6	0.8	78	6.1	2.5	2.6	0.0049	15.2	0.55	940	2.2	0.64	57	3.3	1.4	1.9	LS 100 L	2.2	1400	4.8	0.86	77	6.8	3.2	2.8	0.0039	21	0.75	940	2.3	0.75	63	4.2	1.6	2.1	LS 100 L	3	1410	6.7	0.84	77	6.6	3	2.7	0.0051	24.5	1.1	940	3.2	0.76	65	4.4	1.4	2.1	LS 112 MG	4	1450	9	0.78	82	7	1.9	2.6	0.015	35	1.5	965	4.7	0.70	67	3.6	1.1	1.8	LS 132 SM	5.5	1460	11.7	0.82	84	6.4	2.8	2.8	0.0334	50	1.8	975	6.2	0.62	69	4	1.7	2.2	LS 132 M	7.5	1445	15.5	0.84	83	7	2.2	2.6	0.0385	60	2.5	970	7.4	0.70	70
LS 90 S	1.1	1420	2.6	0.79	77	6	2.5	2.5	0.0039	12.5																																																																																																																																		
	0.37	940	1.5	0.63	57	3.3	1.4	1.8			LS 90 L	1.5	1425	3.6	0.8	78	6.1	2.5	2.6	0.0049	15.2	0.55	940	2.2	0.64	57	3.3	1.4	1.9	LS 100 L	2.2	1400	4.8	0.86	77	6.8	3.2	2.8	0.0039	21	0.75	940	2.3	0.75	63	4.2	1.6	2.1	LS 100 L	3	1410	6.7	0.84	77	6.6	3	2.7	0.0051	24.5	1.1	940	3.2	0.76	65	4.4	1.4	2.1	LS 112 MG	4	1450	9	0.78	82	7	1.9	2.6	0.015	35	1.5	965	4.7	0.70	67	3.6	1.1	1.8	LS 132 SM	5.5	1460	11.7	0.82	84	6.4	2.8	2.8	0.0334	50	1.8	975	6.2	0.62	69	4	1.7	2.2	LS 132 M	7.5	1445	15.5	0.84	83	7	2.2	2.6	0.0385	60	2.5	970	7.4	0.70	70	4.4	1.4	2																
LS 90 L	1.5	1425	3.6	0.8	78	6.1	2.5	2.6	0.0049	15.2																																																																																																																																		
	0.55	940	2.2	0.64	57	3.3	1.4	1.9			LS 100 L	2.2	1400	4.8	0.86	77	6.8	3.2	2.8	0.0039	21	0.75	940	2.3	0.75	63	4.2	1.6	2.1	LS 100 L	3	1410	6.7	0.84	77	6.6	3	2.7	0.0051	24.5	1.1	940	3.2	0.76	65	4.4	1.4	2.1	LS 112 MG	4	1450	9	0.78	82	7	1.9	2.6	0.015	35	1.5	965	4.7	0.70	67	3.6	1.1	1.8	LS 132 SM	5.5	1460	11.7	0.82	84	6.4	2.8	2.8	0.0334	50	1.8	975	6.2	0.62	69	4	1.7	2.2	LS 132 M	7.5	1445	15.5	0.84	83	7	2.2	2.6	0.0385	60	2.5	970	7.4	0.70	70	4.4	1.4	2																																			
LS 100 L	2.2	1400	4.8	0.86	77	6.8	3.2	2.8	0.0039	21																																																																																																																																		
	0.75	940	2.3	0.75	63	4.2	1.6	2.1			LS 100 L	3	1410	6.7	0.84	77	6.6	3	2.7	0.0051	24.5	1.1	940	3.2	0.76	65	4.4	1.4	2.1	LS 112 MG	4	1450	9	0.78	82	7	1.9	2.6	0.015	35	1.5	965	4.7	0.70	67	3.6	1.1	1.8	LS 132 SM	5.5	1460	11.7	0.82	84	6.4	2.8	2.8	0.0334	50	1.8	975	6.2	0.62	69	4	1.7	2.2	LS 132 M	7.5	1445	15.5	0.84	83	7	2.2	2.6	0.0385	60	2.5	970	7.4	0.70	70	4.4	1.4	2																																																						
LS 100 L	3	1410	6.7	0.84	77	6.6	3	2.7	0.0051	24.5																																																																																																																																		
	1.1	940	3.2	0.76	65	4.4	1.4	2.1			LS 112 MG	4	1450	9	0.78	82	7	1.9	2.6	0.015	35	1.5	965	4.7	0.70	67	3.6	1.1	1.8	LS 132 SM	5.5	1460	11.7	0.82	84	6.4	2.8	2.8	0.0334	50	1.8	975	6.2	0.62	69	4	1.7	2.2	LS 132 M	7.5	1445	15.5	0.84	83	7	2.2	2.6	0.0385	60	2.5	970	7.4	0.70	70	4.4	1.4	2																																																																									
LS 112 MG	4	1450	9	0.78	82	7	1.9	2.6	0.015	35																																																																																																																																		
	1.5	965	4.7	0.70	67	3.6	1.1	1.8			LS 132 SM	5.5	1460	11.7	0.82	84	6.4	2.8	2.8	0.0334	50	1.8	975	6.2	0.62	69	4	1.7	2.2	LS 132 M	7.5	1445	15.5	0.84	83	7	2.2	2.6	0.0385	60	2.5	970	7.4	0.70	70	4.4	1.4	2																																																																																												
LS 132 SM	5.5	1460	11.7	0.82	84	6.4	2.8	2.8	0.0334	50																																																																																																																																		
	1.8	975	6.2	0.62	69	4	1.7	2.2			LS 132 M	7.5	1445	15.5	0.84	83	7	2.2	2.6	0.0385	60	2.5	970	7.4	0.70	70	4.4	1.4	2																																																																																																															
LS 132 M	7.5	1445	15.5	0.84	83	7	2.2	2.6	0.0385	60																																																																																																																																		
	2.5	970	7.4	0.70	70	4.4	1.4	2																																																																																																																																				

The top line for each type corresponds to the highest rated speed.

3-phase TEFV induction motors LS aluminium alloy frame Electrical characteristics

E2 - Selection data: two-speed

**4-8
poles**
1500-750 min⁻¹

IP 55 - Cl. F - S1
Centrifugal applications
1 winding (Dahlander)

MAINS SUPPLY 400 V

50 Hz

Type	Rated power at 50 Hz	Rated speed	Rated current	Power factor	Efficiency	Starting current / Rated current	Starting torque / Rated torque	Maximum torque / Rated torque	Moment of inertia	Weight
	P_N kW	N_N min ⁻¹	$I_N(400 V)$ A	$\cos \varphi$	η %	I_D/I_N	M_D/M_N	M_M/M_N	J kg.m ²	IM B3 kg
LS 71 L	0.25	1430	0.8	0.7	65	3.5	1.3	2	0.00085	7.3
	0.06	640	0.4	0.6	38	1.5	1.1	1.3		
LS 71 L	0.37	1430	1.15	0.8	60	4	1.4	2.1	0.0011	8.3
	0.07	670	0.5	0.7	30	2.1	1.2	1.4		
LS 80 L	0.55	1435	1.6	0.71	69	4.8	2.6	2.4	0.0018	9.3
	0.09	715	0.6	0.48	46	2.3	2.8	2.4		
LS 80 L	0.75	1425	2.3	0.72	65	4.8	2.3	2.3	0.0024	10.9
	0.12	710	0.9	0.52	41	2.3	2.7	2.3		
LS 90 S	1.1	1441	3	0.78	67.5	4.1	1.1	1.5	0.0032	11.5
	0.18	724	1.1	0.53	43.5	2.9	1.5	2.3		
LS 90 L	1.5	1459	4.2	0.70	73.4	5.5	1.9	2.5	0.0049	15.2
	0.25	732	1.6	0.44	50.5	3.1	2.8	3.6		
LS 100 L	2.2	1446	5.5	0.78	73.6	5.2	1.7	2.1	0.0051	21
	0.37	726	2	0.50	53.7	3.2	2.4	3		
LS 100 L	3	1435	7.4	0.79	75	5.5	1.6	2.3	0.0071	24.4
	0.55	715	2.6	0.52	58	2.7	2.1	2.1		
LS 112 MU	4	1455	8.7	0.80	82.9	6.7	2.1	2.6	0.015	37
	0.75	730	3.5	0.47	66	3.6	2.9	3.3		
LS 132 SM	5.5	1452	11	0.87	83.3	6.4	2	2.3	0.0334	55
	1.1	726	3.2	0.63	78	3.7	2	1.9		
LS 132 M	7.5	1449	14.7	0.88	83.7	6.3	2	2.3	0.0385	60
	1.5	727	4.3	0.63	79	4.1	2	2.2		
LS 160 M	9	1462	17.9	0.84	86.4	6.4	1.9	2.8	0.057	75
	2.2	724	6.3	0.64	79.2	3.7	1.4	2.2		
LS 160 M	11	1464	21.6	0.84	87.5	7.2	2.1	3	0.068	85
	2.8	724	7.7	0.64	80.9	3.7	1.5	2.2		
LS 160 L	13	1464	25.8	0.83	87.5	6.9	2.1	2.9	0.074	89
	3.3	722	9.1	0.63	80.5	3.7	1.5	2.1		
LS 160 L	15	1462	29.5	0.84	87.5	6.8	2.3	2.8	0.085	97
	3.8	722	10.1	0.64	80.5	3.4	1.4	2		
LS 180 LR	18.5	1462	36.6	0.83	87.9	7.2	2.4	3	0.096	112
	4.8	722	12.1	0.64	81.5	3.6	1.4	2		
LS 180 LU	22	1464	40.9	0.87	89.2	6	2.1	2.4	0.135	150
	5.3	730	13.2	0.68	85.5	3.6	1.8	1.7		
LS 200 LT	24	1468	45.2	0.85	90.1	7.1	2.8	2.8	0.151	165
	6	730	15.4	0.65	86.6	3.7	2.1	1.8		
LS 200 L	30	1475	55.8	0.86	90.3	6.1	2.1	2.4	0.240	200
	7	735	18.6	0.63	86	3.8	1.9	1.8		
LS 225 SR	37	1475	69.2	0.85	90.8	6.8	2.3	2.7	0.290	235
	8.5	735	21.8	0.64	88	4	2.1	1.8		
LS 225 MG	45	1482	83.1	0.85	92	7	2.3	3	0.633	320
	11	738	26.3	0.66	91.3	4	1.8	1.8		
LS 250 ME	55	1484	100.8	0.85	92.7	7.7	2.6	3.4	0.83	380
	14	738	33.1	0.66	92.4	4	1.8	1.9		
LS 250 MF	65	1484	118.7	0.85	93	7.7	2.6	3.4	0.9	430
	16	738	37.7	0.66	92.8	4	1.8	1.9		
LS 280 SD	75	1484	136.9	0.85	93	7.7	2.6	3.4	1.03	450
	19	738	45.5	0.65	92.8	3.9	1.7	1.8		
LS 280 MK	90	1490	163.3	0.85	93.6	8.3	2.8	3.1	2.32	655
	23	742	54.8	0.64	91.3	4.8	2.3	1.9		
LS 315 SP	110	1490	199.1	0.85	93.8	8.3	2.8	2.9	2.79	750
	29	742	69	0.64	91.3	4.8	2.3	1.9		
LS 315 MR	132	1490	238.5	0.85	94	8.3	2.8	2.9	3.27	845
	35	742	86	0.64	91.5	4.9	2.2	2		
LS 315 MR	160	1485	288.4	0.85	94.2	8.3	2.8	2.9	3.27	860
	42	740	103	0.65	91.7	5	2.2	2		

The top line for each type corresponds to the highest rated speed.

3-phase TEFV induction motors LS aluminium alloy frame Electrical characteristics

E2 - Selection data: two-speed

6-12
poles
1000-500 min⁻¹

IP 55 - Cl. F - S1
Centrifugal applications
1 winding (Dahlander)

MAINS SUPPLY 400 V

50 Hz

Type	Rated power at 50 Hz	Rated speed	Rated current	Power factor	Efficiency	Starting current / Rated current	Starting torque / Rated torque	Maximum torque / Rated torque	Moment of inertia	Weight
	P_N kW	N_N min ⁻¹	I_N (400 V) A	$\cos \varphi$	η %	I_D/I_N	M_D/M_N	M_M/M_N	J kg.m ²	IM B3 kg
LS 90 L	0.75	910	2.1	0.82	64	3.8	1.6	2	0.0039	15
	0.15	425	0.8	0.68	42	2.1	1.6	1.8		
LS 90 LU	1.1	915	3.2	0.77	65	4.2	2.3	2.7	0.0051	17
	0.18	450	1.2	0.54	40	2.3	2.7	3		
LS 100 L	1.5	915	4	0.79	68	4.5	1.9	1.8	0.0071	25
	0.25	450	1.5	0.55	44	2.4	2.3	2.6		
LS 112 MU	2.2	950	5.6	0.79	71	4.5	1.4	1.9	0.0177	37
	0.37	465	2.1	0.52	50	2.1	1.1	1.6		
LS 132 SM	3	955	8	0.70	77	4.5	2.2	2	0.028	55
	0.55	465	3.8	0.43	58	2.4	1.7	1.6		
LS 132 M	4	955	10.4	0.71	77	4.8	2	2.2	0.033	60
	0.65	465	3.1	0.45	58	2	1.53	1.36		
LS 132 MU	5.5	950	14.1	0.71	79	4.9	2.1	2.3	0.046	68
	1	450	5.4	0.45	59	1.9	1.5	1.4		
LS 160 M	7.5	975	17.5	0.77	80.5	5	1.5	2.3	0.093	86
	1.3	485	5.5	0.51	66.6	2.4	1.3	1.6		
LS 160 LU	11	975	26.2	0.73	82.9	5.5	1.9	2.6	0.151	108
	1.8	485	8	0.45	71.8	2.9	1.7	2.1		
LS 180 LU	15	975	33.4	0.76	85.4	6	2.1	2.6	0.214	146
	2.5	485	10.4	0.46	75.2	2.8	1.9	1.9		
LS 200 L	18.5	980	38.2	0.80	87.4	6.1	2	2.6	0.324	205
	3	488	11.5	0.52	72.4	2.9	1.4	1.8		
LS 200 LU	25	980	52.2	0.79	87.5	7	2.3	3	0.38	235
	4.5	485	16.6	0.54	72.4	2.7	1.3	1.8		

The top line for each type corresponds to the highest rated speed.

3-phase TEFV induction motors LS aluminium alloy frame Electrical characteristics

E2 - Selection data: two-speed

General table of two-speed motors

IP 55 - Cl. F - S1
Centrifugal applications

MAINS SUPPLY Δ 400 V 50 Hz

Type	2/4 Poles Dahlander	4/6 Poles PAM	4/6 Poles 2 windings	4/8 Poles Dahlander	6/12 Poles Dahlander
	P_N kW	P_N kW	P_N kW	P_N kW	P_N kW
LS 71 M	0.37 / 0.075	-	-	0.25 / 0.06	-
LS 71 M	0.55 / 0.11	-	-	0.37 / 0.07	-
LS 80 L	-	-	-	0.55 / 0.09	-
LS 80 L	1.1 / 0.25	0.75 / 0.25	0.7 / 0.2	0.75 / 0.12	-
LS 90 S	1.5 / 0.35	-	0.85 / 0.25	1.1 / 0.18	-
LS 90 SL	-	1.1 / 0.37	-	-	-
LS 90 L	2.2 / 0.6	1.5 / 0.55	1.4 / 0.5	1.5 / 0.25	0.75 / 0.15
LS 90 LU	-	-	-	-	1.1 / 0.18
LS 100 L	-	2.2 / 0.75	2.4 / 0.75	2.2 / 0.37	1.5 / 0.25
LS 100 L	3 / 0.8	3 / 1.1	-	3 / 0.55	-
LS 112 MG	-	-	3.4 / 1.1	-	-
LS 112 MU	4.5 / 1.3	4 / 1.5	-	4 / 0.75	2.2 / 0.37
LS 132 SM	6 / 1.6	5.5 / 1.8	4 / 1.2	5.5 / 1.1	3 / 0.55
LS 132 M	9 / 2.5	7.5 / 2.5	6.3 / 1.9	7.5 / 1.5	4 / 0.65
LS 132 MU	-	-	-	-	5.5 / 1
LS 160 M	-	-	9 / 3	9 / 2.2	7.5 / 1.3
LS 160 M	13.5 / 3.3	-	11 / 3.7	11 / 2.8	-
LS 160 L	19 / 4.5	-	13 / 4.3	13 / 3.3	-
LS 160 L	-	-	-	15 / 3.8	-
LS 160 LU	-	-	15 / 5	-	11 / 1.8
LS 180 L	-	-	18.5 / 6.5	18.5 / 4.8	-
LS 180 LU	24 / 8	-	22 / 7.5	22 / 5.3	15 / 2.5
LS 200 LT	-	-	-	24 / 6	-
LS 200 L	31 / 11	-	25 / 8.5	30 / 7	18.5 / 3
LS 200 LU	40 / 14	-	30 / 9	-	25 / 4.5
LS 225 SR	-	-	34 / 11	37 / 8.5	-
LS 225 MG	50 / 17	-	-	45 / 11	-
LS 250 ME	59 / 20	-	42 / 14	55 / 14	-
LS 250 ME	70 / 24	-	-	-	-
LS 250 MF	-	-	52 / 19	65 / 16	-
LS 280 SD	-	-	-	75 / 19	-
LS 280 SK	-	-	75 / 28	-	-
LS 280 MD	85 / 30	-	-	-	-
LS 280 MK	-	-	90 / 33	90 / 23	-
LS 315 SP	-	-	110 / 37	110 / 29	-
LS 315 MP	-	-	-	132 / 35	-
LS 315 MR	100 / 35	-	132 / 44	160 / 42	-

The specific electrical characteristics for these motors are available on request.

The characteristics tables detail intermediate powers which are not described in the above table.

3-phase TEFV induction motors LS aluminium alloy frame Electrical characteristics

E2 - Selection data: two-speed

General table of two-speed motors

IP 55 - Cl. F - S1
General applications

MAINS SUPPLY Δ 400 V 50 Hz

Type	2/4 Poles Dahlander	2/4 Poles 2 windings	2/6 Poles 2 windings	2/8 Poles 2 windings	4/6 Poles 2 windings	4/8 Poles Dahlander
	P_N kW	P_N kW	P_N kW	P_N kW	P_N kW	P_N kW
LS 71 M	-	-	-	0.18 / 0.045	0.12 / 0.09	-
LS 71 M	-	-	-	0.25 / 0.06	0.18 / 0.12	-
LS 71 M	0.37 / 0.25	-	-	0.37 / 0.09	-	0.25 / 0.12
LS 71 M	0.55 / 0.37	-	-	0.55 / 0.18	-	0.37 / 0.18
LS 71 L	-	0.37 / 0.09	0.25 / 0.08	-	-	-
LS 80 L	1.1 / 0.75	-	0.55 / 0.18	0.55 / 0.12	0.45 / 0.3	0.55 / 0.22
LS 90 S	1.5 / 1.1	0.75 / 0.37	0.75 / 0.25	0.75 / 0.18	0.7 / 0.45	0.75 / 0.4
LS 90 L	2.2 / 1.5	-	1.5 / 0.5	-	1.1 / 0.75	1.2 / 0.6
LS 90 LU	-	-	-	1.5 / 0.37	-	-
LS 100 L	3 / 2.6	2.2 / 1.1	2.2 / 0.75	2.2 / 0.55	1.8 / 1.2	1.7 / 0.9
LS 112 MG	4.5 / 3.7	3.3 / 1.7	-	3 / 0.75	2.8 / 1.8	2.8 / 1.5
LS 112 MU	5.5 / 4	-	3 / 1	-	3 / 2	3 / 1.8
LS 132 SM	6 / 4.5	3.7 / 1.85	4 / 1.3	4 / 1	4 / 2.8	5 / 2.85
LS 132 M	9 / 6.9	6 / 3	6.5 / 2.2	5.5 / 1.6	5.5 / 3.7	7.6 / 4
LS 160 M	13.5 / 10.3	-	-	-	5.9 / 3.9	8.1 / 4.5
LS 160 L	18.5 / 14	-	-	-	8.1 / 5.2	11 / 6
LS 180 LR	21 / 16	-	-	-	12 / 7.7	-
LS 180 L	-	-	-	-	14 / 9	14.5 / 9
LS 180 LU	25 / 19	-	-	-	-	16.5 / 11
LS 200 LT	-	-	-	-	-	18.5 / 12.5
LS 200 L	33 / 25	-	-	-	17 / 11.5	-
LS 200 L	-	-	-	-	21 / 14	22 / 15
LS 225 MR	37 / 26.5	-	-	-	24 / 16	-
LS 225 MG	44 / 33	-	-	-	28 / 18.5	28 / 19.5
LS 250 ME	52 / 40.5	-	-	-	33 / 22	-
LS 250 MF	-	-	-	-	39 / 22.5	40 / 26
LS 250 MF	-	-	-	-	45 / 30	50 / 33
LS 280 SC	62.5 / 51.5	-	-	-	-	-
LS 280 SD	-	-	-	-	-	55 / 37
LS 280 MD	81 / 66	-	-	-	-	-
LS 280 MK	-	-	-	-	55 / 40	66 / 45
LS 315 SP	-	-	-	-	62.5 / 42	80 / 50
LS 315 MR	95 / 78	-	-	-	78 / 51.5	95 / 60

The specific electrical characteristics for these motors are available on request.

3-phase TEFV induction motors LS aluminium alloy frame Dimensions

PAGES

F1 - Dimensions of shaft extensions 104

F2 - Foot mounted IM B3 (IM 1001) 105

F3 - Foot and flange mounted IM B35 (IM 2001) 106

F4 - Flange mounted IM B5 (IM 3001) 107

F5 - Foot and face mounted IM B34 (IM 2101) 108

F6 - Face mounted IM B14 (IM 3601) 109

The dimensions in the tables are valid for all operating positions defined on page 27.

3-phase TEFV induction motors LS aluminium alloy frame Dimensions

F1 - Dimensions of shaft extensions

Dimensions in millimetres

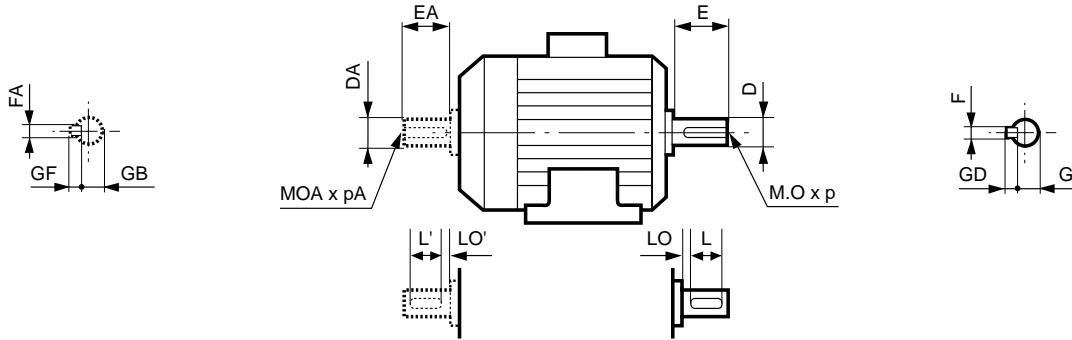

Main shaft extensions

Type	4, 6 and 8 poles									2 and 2/4 poles								
	F	GD	D	G	E	O	p	L	LO	F	GD	D	G	E	O	p	L	LO
LS 56 M	3	3	9j6	7	20	4	10	16	3	3	3	9j6	7	20	4	10	16	3
LS 63 M	4	4	11j6	8,5	23	4	10	18	3,5	4	4	11j6	8,5	23	4	10	18	3,5
LS 71 L	5	5	14j6	11	30	5	15	25	3,5	5	5	14j6	11	30	5	15	25	3,5
LS 80 L	6	6	19j6	15,5	40	6	16	30	6	6	6	19j6	15,5	40	6	16	30	6
LS 90 S/L/LU/SL	8	7	24j6	20	50	8	19	40	6	8	7	24j6	20	50	8	19	40	6
LS 100 L	8	7	28j6	24	60	10	22	50	6	8	7	28j6	24	60	10	22	50	6
LS 112 M/MG/MU	8	7	28j6	24	60	10	22	50	6	8	7	28j6	24	60	10	22	50	6
LS 132 S/M/SM	10	8	38k6	33	80	12	28	63	10	10	8	38k6	33	80	12	28	63	10
LS 160 M/L/LU/MP/LR	12	8	42k6	37	110	16	36	100	6	12	8	42k6	37	110	16	36	100	6
LS 180 MT/LR/L/LU	14	9	48k6	42,5	110	16	36	98	12	14	9	48k6	42,5	110	16	36	98	12
LS 200 LT/L/LU	16	10	55m6	49	110	20	42	97	13	16	10	55m6	49	110	20	42	97	13
LS 225 ST/MT/MR/SR/MG	18	11	60m6	53	140	20	42	126	14	18	11	60m6	53	140	20	42	97	13
LS 250 MZ/ME/MF	18	11	65m6	58	140	20	42	126	14	18	11	60m6	53	140	20	42	126	14
LS 280 SC/SD/MC/MD	20	12	75m6	67,5	140	20	42	125	15	18	11	65m6	58	140	20	42	126	14
LS 280 SK/MK	20	12	75m6	67,5	140	20	42	125	15	18	11	65m6	58	140	20	42	126	14
LS 315 SP/MP/MR	22	14	80m6	71	170	20	42	155	15	18	11	65m6	58	140	20	42	126	14

Secondary shaft extensions

Type	4, 6 and 8 poles									2 and 2/4 poles								
	FA	GF	DA	GB	EA	OA	pA	L'	LO'	FA	GF	DA	GB	EA	OA	pA	L'	LO'
LS 56 M	3	3	9j6	7	20	4	10	16	3	3	3	9j6	7	20	4	10	16	3
LS 63 M	4	4	11j6	8,5	23	4	10	18	3,5	4	4	11j6	8,5	23	4	10	18	3,5
LS 71 L	5	5	14j6	11	30	5	15	25	3,5	5	5	14j6	11	30	5	15	25	3,5
LS 80 L	5	5	14j6	11	30	5	15	25	3,5	5	5	14j6	11	30	5	15	25	3,5
LS 90 S/L/LU/SL	6	6	19j6	15,5	40	6	16	30	6	6	6	19j6	15,5	40	6	16	30	6
LS 100 L	8	7	24j6	20	50	8	19	40	6	8	7	24j6	20	50	8	19	40	6
LS 112 M/MG/MU	8	7	24j6	20	50	8	19	40	6	8	7	24j6	20	50	8	19	40	6
LS 132 S/M/SM	8	7	28j6	24	60	10	22	50	6	8	7	28j6	24	60	10	22	50	6
LS 160 M/L/LU/MP/LR	12	8	38k6	37	80	16	36	100	6	12	8	38k6	37	80	16	36	100	6
LS 180 MT/LR/L/LU	14	9	48k6	42,5	110	16	36	98	12	14	9	48k6	42,5	110	16	36	98	12
LS 200 LT/L/LU	16	10	55m6	49	110	20	42	97	13	16	10	55m6	49	110	20	42	97	13
LS 225 ST/MT/MR/SR/MG	18	11	60m6	53	140	20	42	126	14	18	11	60m6	53	140	20	42	97	13
LS 250 MZ/ME/MF	18	11	60m6	53	140	20	42	126	14	18	11	60m6	53	140	20	42	126	14
LS 280 SC/SD/MC/MD	18	11	65m6	58	140	20	42	126	14	18	11	65m6	58	140	20	42	126	14
LS 280 SK/MK	20	12	75m6	67,5	140	20	42	125	15	18	11	65m6	58	140	20	42	126	14
LS 315 SP/MP/MR	22	14	80m6	71	170	20	42	155	15	18	11	65m6	58	140	20	42	126	14

3-phase TEFV induction motors LS aluminium alloy frame Dimensions

F2 - Foot mounted IM B3 (IM 1001)

Dimensions in millimetres

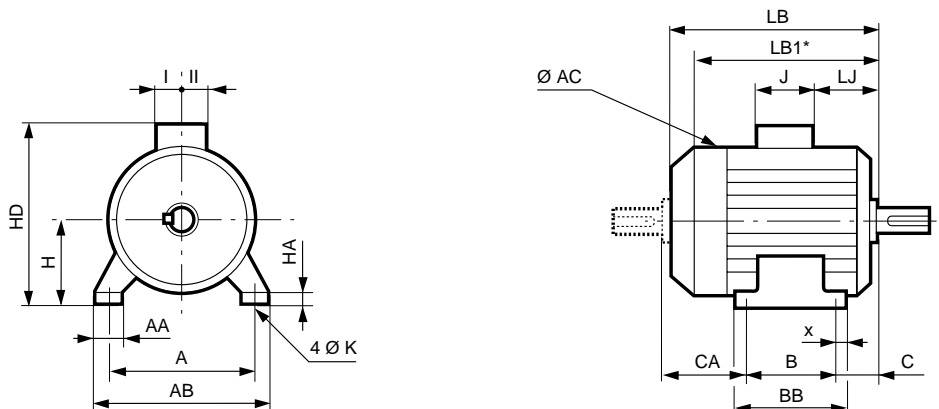

Type	Main dimensions																		
	A	AB	B	BB	C	X	AA	K	HA	H	AC	HD	LB	LB1*	LJ	J	I	II	CA
LS 56 M	90	104	71	87	36	8	24	6	7	56	110	140	156	134	16	86	43	43	51
LS 63 M	100	115	80	96	40	8	26	7	9	63	124	152	172	165	26	86	43	43	55
LS 71 L	112	126	90	106	45	8	24	7	9	71	140	170	193	166	21	86	43	43	61
LS 80 L	125	157	100	120	50	10	29	9	10	80	170	203	215	177	26	86	43	43	68
LS 80 LU	125	157	100	120	50	10	29	9	10	80	170	203	267	232	26	86	43	43	120
LS 90 S	140	172	100	120	56	10	37	10	11	90	190	223	218	177	26	86	43	43	66
LS 90 L/SL	140	172	125	162	56	28	37	10	11	90	190	223	245	204	26	86	43	43	68
LS 90 LU	140	172	125	162	56	28	37	10	11	90	190	223	265	230	26	86	43	43	88
LS 100 L	160	196	140	165	63	12	40	12	13	100	200	238	290	250	26	86	43	43	93
LS 112 M	190	220	140	165	70	12	45	12	14	112	200	250	290	250	26	86	43	43	86
LS 112 MG	190	220	140	165	70	12	52	12	14	112	235	260	315	265	36	86	43	43	110
LS 112 MU	190	220	140	165	70	12	52	12	14	112	235	260	334	288	36	86	43	43	130
LS 132 S	216	250	140	170	89	16	50	12	15	132	235	280	350	306	53	86	43	43	128
LS 132 SM/M	216	250	178	208	89	16	59	12	18	132	280	307	387	327	25	110	57	73	126
LS 132 MU	216	250	178	208	89	16	59	12	18	132	280	307	410	351	25	110	57	73	148
LS 160 MP	254	294	210	294	108	20	64	14,5	25	160	315	368	468	407	44	134	92	63	154
LS 160 M	254	294	210	294	108	20	60	14,5	25	160	316	395	495	435	44	134	92	63	182
LS 160 LR	254	294	254	294	108	20	64	14,5	25	160	315	368	495	440	44	134	92	63	138
LS 160 L	254	294	254	294	108	20	60	14,5	25	160	316	395	495	435	44	134	92	63	138
LS 160 LU	254	294	254	294	108	20	60	14,5	25	160	316	395	510	450	44	134	92	63	153
LS 180 MT	279	324	241	316	121	20	79	14,5	28	180	316	428	495	435	45	205	100	95	138
LS 180 LR	279	324	279	316	121	20	79	14,5	28	180	316	428	520	450	45	205	100	95	125
LS 180 L	279	339	279	329	121	25	86	14,5	25	180	350	435	552	481	54	205	100	95	159
LS 180 LU	279	339	279	329	121	25	86	14,5	25	180	350	435	593	508	54	205	100	95	199
LS 200 LT	318	378	305	365	133	30	108	18,5	30	200	350	455	599	514	60	205	100	95	167
LS 200 L	318	388	305	375	133	35	103	18,5	36	200	390	475	621	539	68	205	100	95	194
LS 200 LU	318	388	305	375	133	35	103	18,5	36	200	390	475	669	586	68	205	100	95	244
LS 225 ST	356	431	286	386	149	50	127	18,5	36	225	390	500	627	545	74	205	100	95	203
LS 225 SR	356	431	286	386	149	50	127	18,5	36	225	390	500	676	593	74	205	100	95	253
LS 225 MT	356	431	311	386	149	50	127	18,5	36	225	390	500	627	545	74	205	100	95	178
LS 225 MR	356	431	311	386	149	50	127	18,5	36	225	390	500	676	593	74	205	100	95	228
LS 225 MG	356	420	311	375	149	30	65	18,5	30	225	479	629	810	716	68	292	148	180	360
LS 250 MZ	406	470	349	449	168	70	150	24	47	250	390	550	676	593	68	217	103	145	171
LS 250 ME	406	470	349	420	168	35	90	24	36	250	479	655	810	716	68	292	148	180	303
LS 250 MF	406	470	349	420	168	35	90	24	36	250	479	655	870	776	68	292	148	180	363
LS 280 SC	457	520	368	478	190	35	90	24	35	280	479	685	810	716	68	292	148	180	262
LS 280 SD	457	520	368	478	190	35	90	24	35	280	479	685	870	776	68	292	148	180	322
LS 280 SK	457	533	368	495	190	40	85	24	35	280	586	746	921	819	99	292	148	180	379
LS 280 MC	457	520	419	478	190	35	90	24	35	280	479	685	810	716	68	292	148	180	211
LS 280 MD	457	520	419	478	190	35	90	24	35	280	479	685	870	776	68	292	148	180	271
LS 280 MK	457	533	419	495	190	40	85	24	35	280	586	746	921	819	99	292	148	180	328
LS 315 SP	508	594	406	537	216	40	114	28	70	315	586	781	947	845	125	292	148	180	341
LS 315 MP	508	594	457	537	216	40	114	28	70	315	586	781	947	845	125	292	148	180	290
LS 315 MR	508	594	457	537	216	40	114	28	70	315	586	781	1017	915	125	292	148	180	360

* LB1: non-ventilated motor

3-phase TEFV induction motors LS aluminium alloy frame Dimensions

F3 - Foot and flange mounted IM B35 (IM 2001)

Dimensions in millimetres

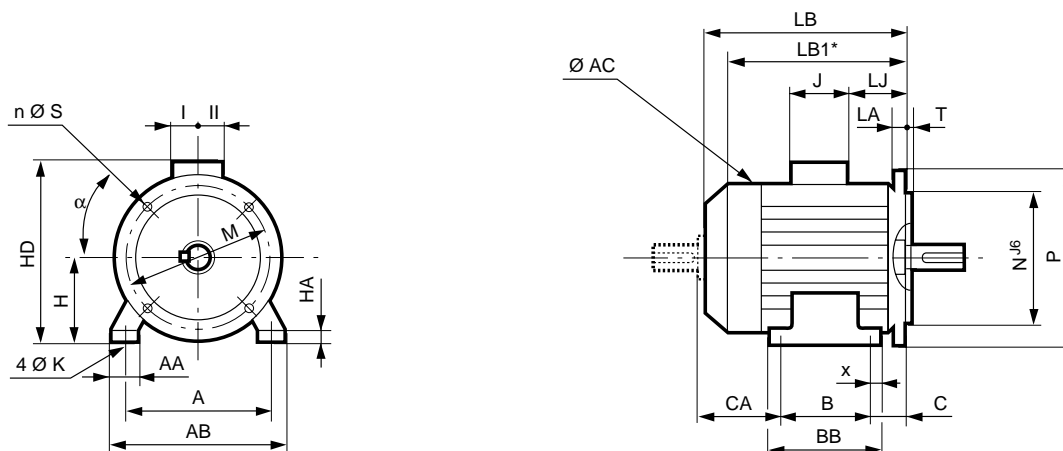

Type	Main dimensions																			Sym.
	A	AB	B	BB	C	X	AA	K	HA	H	AC	HD	LB	LB1*	HJ	LJ	J	I	II	
LS 56 M	90	104	71	87	36	8	25	6	7	56	110	140	156	134	84	16	86	43	43	FF 100
LS 63 M	100	115	80	96	40	8	26	7	9	63	124	152	172	165	89	26	86	43	43	FF 115
LS 71 L	112	126	90	106	45	8	24	7	9	71	140	170	193	166	99	26	86	43	43	FF 130
LS 80 L	125	157	100	120	50	10	29	9	10	80	170	203	215	177	123	26	86	43	43	FF 165
LS 80 LU	125	157	100	120	50	10	29	9	10	80	170	203	267	232	123	26	86	43	43	FF 165
LS 90 S	140	172	100	120	76	10	37	10	11	90	190	223	238	197	133	46	86	43	43	FF 165
LS 90 L/SL	140	172	125	162	76	8	37	10	11	90	190	223	265	224	133	46	86	43	43	FF 165
LS 90 LU	140	172	125	162	76	28	37	10	11	90	190	223	285	250	133	46	86	43	43	FF 165
LS 100 L	160	196	140	165	63	12	40	12	13	100	200	238	290	250	138	26	86	43	43	FF 215
LS 112 M	190	220	140	165	70	12	45	12	14	112	200	250	290	250	138	26	86	43	43	FF 215
LS 112 MG	190	220	140	165	70	12	52	12	14	112	235	260	315	265	148	36	86	43	43	FF 215
LS 112 MU	190	220	140	165	70	12	52	12	14	112	235	260	334	288	148	36	86	43	43	FF 215
LS 132 S	216	250	140	170	89	16	50	12	15	132	235	280	350	306	148	53	86	43	43	FF 265
LS 132 SM/M	216	250	178	208	89	16	59	12	18	132	280	307	387	327	175	25	110	57	73	FF 265
LS 132 MU	216	250	178	208	89	16	59	12	18	132	280	307	410	351	175	25	110	57	73	FF 265
LS 160 MP	254	294	210	294	108	20	64	14,5	25	160	315	368	468	407	208	44	134	92	63	FF 300
LS 160 M	254	294	210	294	108	20	60	14,5	25	160	316	395	495	435	235	44	134	92	63	FF 300
LS 160 LR	254	294	254	294	108	20	64	14,5	25	160	315	368	495	440	208	44	134	92	63	FF 300
LS 160 L	254	294	254	294	108	20	60	14,5	25	160	316	395	495	435	235	44	134	92	63	FF 300
LS 160 LU	254	294	254	294	108	20	60	14,5	25	160	316	395	510	450	235	44	134	92	63	FF 300
LS 180 MT	279	324	241	316	121	20	79	14,5	28	180	316	428	495	435	248	45	205	100	95	FF 300
LS 180 LR	279	324	279	316	121	20	79	14,5	28	180	316	428	520	450	248	45	205	100	95	FF 300
LS 180 L	279	339	279	329	121	25	86	14,5	25	180	350	435	552	481	255	54	205	100	95	FF 300
LS 180 LU	279	339	279	329	121	25	86	14,5	25	180	350	435	593	508	255	54	205	100	95	FF 300
LS 200 LT	318	378	305	365	133	30	108	18,5	30	200	350	455	599	514	255	60	205	100	95	FF 350
LS 200 L	318	388	305	375	133	35	103	18,5	36	200	390	475	621	539	275	68	205	100	95	FF 350
LS 200 LU	318	388	305	375	133	35	103	18,5	36	200	390	475	669	586	275	68	205	100	95	FF 350
LS 225 ST	356	431	286	386	149	50	127	18,5	36	225	390	500	627	545	275	74	205	100	95	FF 400
LS 225 SR	356	431	286	386	149	50	127	18,5	36	225	390	500	676	593	275	74	205	100	95	FF 400
LS 225 MT	356	431	311	386	149	50	127	18,5	36	225	390	500	627	545	275	74	205	100	95	FF 400
LS 225 MR	356	431	311	386	149	50	127	18,5	36	225	390	500	676	593	275	74	205	100	95	FF 400
LS 225 MG	356	420	311	375	149	30	65	18,5	30	225	479	629	810	716	405	68	292	148	180	FF 400
LS 250 MZ	406	470	349	449	168	70	150	24	47	250	390	550	676	593	300	68	217	103	145	FF 500
LS 250 ME	406	470	349	420	168	35	90	24	36	250	479	655	810	716	405	68	292	148	180	FF 500
LS 250 MF	406	470	349	420	168	35	90	24	36	250	479	655	870	776	405	68	292	148	180	FF 500
LS 280 SC	457	520	368	478	190	35	90	24	35	280	479	685	810	716	405	68	292	148	180	FF 500
LS 280 SD	457	520	368	478	190	35	90	24	35	280	479	685	870	776	405	68	292	148	180	FF 500
LS 280 SK	457	533	368	495	190	40	85	24	35	280	586	746	921	819	466	99	292	148	180	FF 500
LS 280 MC	457	520	419	478	190	35	90	24	35	280	479	685	810	716	405	68	292	148	180	FF 500
LS 280 MD	457	520	419	478	190	35	90	24	35	280	479	685	870	776	405	68	292	148	180	FF 500
LS 280 MK	457	533	419	495	190	40	85	24	35	280	586	746	921	819	466	99	292	148	180	FF 500
LS 315 SP	508	594	406	537	216	40	114	28	70	315	586	781	947	845	466	125	292	148	180	FF 600
LS 315 MP	508	594	457	537	216	40	114	28	70	315	586	781	947	845	466	125	292	148	180	FF 600
LS 315 MR	508	594	457	537	216	40	114	28	70	315	586	781	1017	915	466	125	292	148	180	FF 600

* LB1: non-ventilated motor

Dimension CA and shaft extension dimensions are identical to those for foot mounted motors (page 104).

3-phase TEFV induction motors LS aluminium alloy frame Dimensions

F4 - Flange mounted IM B5 (IM 3001)

Dimensions in millimetres

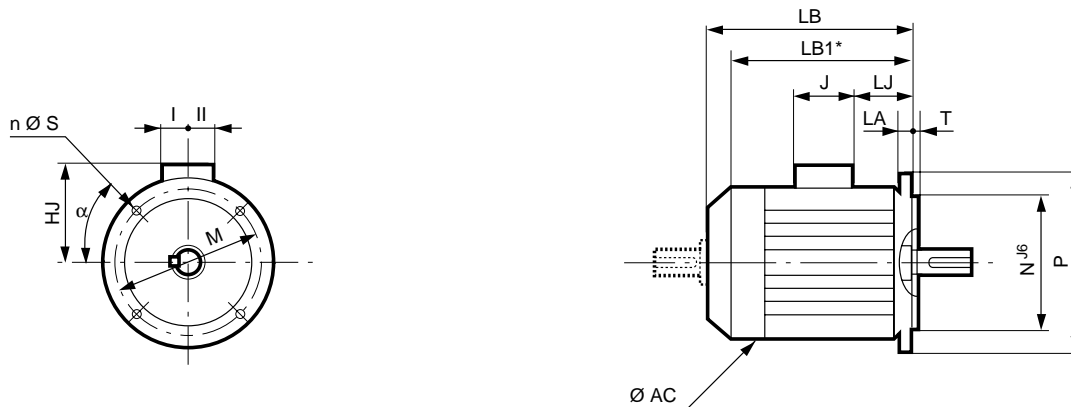

IEC symbol	Flange dimensions							
	M	N	P	T	n	α	S	LA
FF 100	100	80	120	2,5	4	45	7	5
FF 115	115	95	140	3	4	45	10	10
FF 130	130	110	160	3,5	4	45	10	10
FF 165	165	130	200	3,5	4	45	12	10
FF 165	165	130	200	3,5	4	45	12	10
FF 165	165	130	200	3,5	4	45	12	10
FF 165	165	130	200	3,5	4	45	12	10
FF 215	215	180	250	4	4	45	14,5	12
FF 215	215	180	250	4	4	45	14,5	12
FF 215	215	180	250	4	4	45	14,5	12
FF 215	215	180	250	4	4	45	14,5	12
FF 265	265	230	300	4	4	45	14,5	14
FF 265	265	230	300	4	4	45	14,5	14
FF 265	265	230	300	4	4	45	14,5	14
FF 300	300	250	350	5	4	45	18,5	14
FF 300	300	250	350	5	4	45	18,5	14
FF 300	300	250	350	5	4	45	18,5	14
FF 300	300	250	350	5	4	45	18,5	14
FF 300	300	250	350	5	4	45	18,5	14
FF 300	300	250	350	5	4	45	18,5	14
FF 300	300	250	350	5	4	45	18,5	14
FF 300	300	250	350	5	4	45	18,5	14
FF 350	350	300	400	5	4	45	18,5	15
FF 350	350	300	400	5	4	45	18,5	15
FF 350	350	300	400	5	4	45	18,5	15
FF 400	400	350	450	5	8	22,5	18,5	16
FF 400	400	350	450	5	8	22,5	18,5	16
FF 400	400	350	450	5	8	22,5	18,5	16
FF 400	400	350	450	5	8	22,5	18,5	16
FF 400	400	350	450	5	8	22,5	18,5	16
FF 500	500	450	550	5	8	22,5	18,5	18
FF 500	500	450	550	5	8	22,5	18,5	18
FF 500	500	450	550	5	8	22,5	18,5	18
FF 500	500	450	550	5	8	22,5	18,5	18
FF 500	500	450	550	5	8	22,5	18,5	18
FF 500	500	450	550	5	8	22,5	18,5	18
FF 500	500	450	550	5	8	22,5	18,5	18
FF 500	500	450	550	5	8	22,5	18,5	18
FF 500	500	450	550	5	8	22,5	18,5	18
FF 600	600	550	660	6	8	22,5	24	22
FF 600	600	550	660	6	8	22,5	24	22
FF 600	600	550	660	6	8	22,5	24	22

Type	Main dimensions							
	AC	LB	LB1*	HJ	LJ	J	I	II
LS 56 M	110	156	134	84	16	86	43	43
LS 63 M	124	172	165	89	26	96	43	43
LS 71 L	140	193	166	99	26	86	43	43
LS 80 L	170	215	177	123	26	86	43	43
LS 80 LU	170	267	232	123	26	86	43	43
LS 90 S	190	238	197	133	46	86	43	43
LS 90 L/SL	190	265	224	133	46	86	43	43
LS 90 LU	190	285	250	133	46	86	43	43
LS 100 L	200	290	250	138	26	86	43	43
LS 112 M	200	290	250	138	26	86	43	43
LS 112 MG	235	315	265	148	36	86	43	43
LS 112 MU	235	334	288	148	36	86	43	43
LS 132 S	235	350	306	148	53	86	43	43
LS 132 S/M/M	280	387	327	175	25	110	57	73
LS 132 MU	280	410	351	175	25	110	57	73
LS 160 MP	315	468	407	208	44	134	92	63
LS 160 M	316	495	435	235	44	134	92	63
LS 160 LR	315	495	440	208	44	134	92	63
LS 160 L	316	495	435	235	44	134	92	63
LS 160 LU	316	510	450	235	44	134	92	63
LS 180 MT	316	495	435	248	45	205	100	95
LS 180 LR	316	520	450	248	45	205	100	95
LS 180 L	350	552	481	255	54	205	100	95
LS 180 LU	350	593	508	255	54	205	100	95
LS 200 LT	350	599	514	255	60	205	100	95
LS 200 L	390	621	539	275	68	205	100	95
LS 200 LU	390	669	586	275	68	205	100	95
LS 225 ST	390	627	545	275	74	205	100	95
LS 225 SR	390	676	593	275	74	205	100	95
LS 225 MT	390	627	545	275	74	205	100	95
LS 225 MR	390	676	593	275	74	205	100	95
LS 225 MG	479	810	716	405	68	292	148	180
LS 250 MZ**	390	676	593	300	68	217	103	145
LS 250 ME**	479	810	716	405	68	292	148	180
LS 250 MF**	479	870	776	405	68	292	148	180
LS 280 SC**	479	810	716	405	68	292	148	180
LS 280 SD**	479	870	776	405	68	292	148	180
LS 280 SK**	586	921	819	466	99	292	148	180
LS 280 MC**	479	810	716	405	68	292	148	180
LS 280 MD**	479	870	776	405	68	292	148	180
LS 280 MK**	586	921	819	466	99	292	148	180
LS 315 SP**	586	947	845	466	125	292	148	180
LS 315 MP**	586	947	845	466	125	292	148	180
LS 315 MR**	586	1017	915	466	125	292	148	180

* LB1: non-ventilated motor

** For IM 3001 types of use for frame sizes ≥ 250 mm, please consult Leroy Somer.

IM 3011 use

Dimension CA and shaft extension dimensions are identical to those for foot mounted motors (page 104).

3-phase TEFV induction motors LS aluminium alloy frame Dimensions

F5 - Foot and face mounted IM B34 (IM 2101)

Dimensions in millimetres

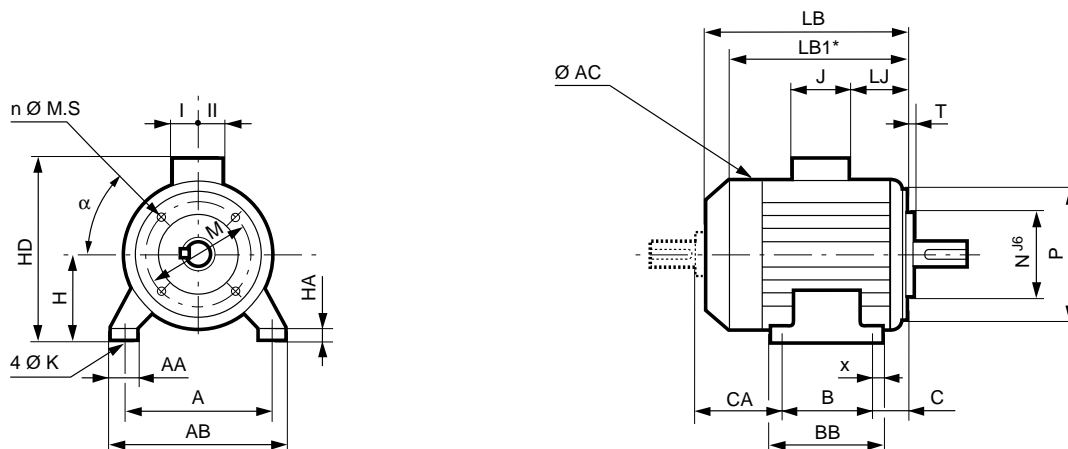

Type	Main dimensions																			Sym.
	A	AB	B	BB	C	X	AA	K	HA	H	AC	HD	LB	LB1*	HJ	LJ	J	I	II	
LS 56 M	90	104	71	87	36	8	25	6	7	56	110	140	156	134	84	16	86	43	43	FT 65
LS 63 M	100	115	80	96	40	8	26	7	9	63	124	152	172	165	89	26	86	43	43	FT 75
LS 71 L	112	126	90	106	45	8	24	7	9	71	140	170	193	166	99	26	86	43	43	FT 85
LS 80 L	125	157	100	120	50	10	29	9	10	80	170	203	215	177	123	26	86	43	43	FT 100
LS 80 LU	125	157	100	120	50	10	29	9	10	80	170	203	267	232	123	26	86	43	43	FT 100
LS 90 S	140	172	100	120	56	10	37	10	11	90	190	223	218	177	133	26	86	43	43	FT 115
LS 90 L/SL	140	172	125	162	56	28	37	10	11	90	190	223	245	204	133	26	86	43	43	FT 115
LS 90 LU	140	172	125	162	56	28	37	10	11	90	190	223	265	230	133	26	86	43	43	FT 115
LS 100 L	160	196	140	165	63	12	40	12	13	100	200	238	290	250	138	26	86	43	43	FT 130
LS 112 M	190	220	140	165	70	12	45	12	14	112	200	250	290	250	138	26	86	43	43	FT 130
LS 112 MG	190	220	140	165	70	12	52	12	14	112	235	260	315	265	148	36	86	43	43	FT 130
LS 112 MU	190	220	140	165	70	12	52	12	14	112	235	260	334	288	148	36	86	43	43	FT 130
LS 132 S	216	250	140	170	89	16	50	12	15	132	235	280	350	306	148	53	86	43	43	FT 215
LS 132 SM/M	216	250	178	208	89	16	59	12	18	132	280	307	387	327	175	25	110	57	73	FT 215
LS 132 MU	216	250	178	208	89	16	59	12	18	132	280	307	410	351	175	25	110	57	73	FT 215
LS 160 MP	254	294	210	250	108	20	112	14	25	315	307	468	175	407	175	70	110	57	73	FT 215
LS 160 LR	254	294	254	294	108	20	112	14	25	315	307	495	175	440	175	70	110	57	73	FT 215

* LB1: non-ventilated motor

Dimension CA and shaft extension dimensions are identical to those for foot mounted motors (page 104).

3-phase TEFV induction motors LS aluminium alloy frame Dimensions

F6 - Face mounted IM B14 (IM 3601)

Dimensions in millimetres

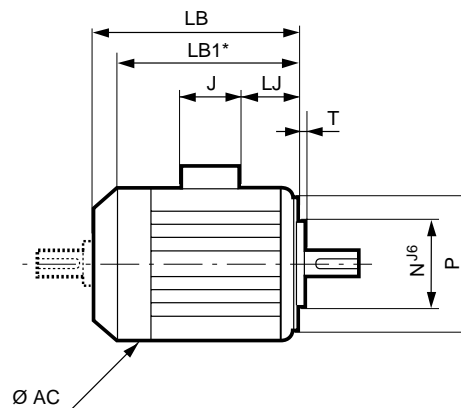
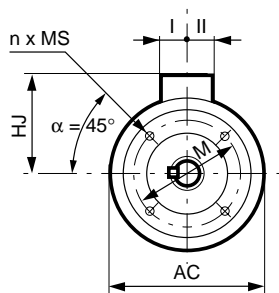

IEC symbol	Flange dimensions					
	M	N	P	T	n	MS
FT 65	65	50	80	2,5	4	M5
FT 75	75	60	90	2,5	4	M5
FT 85	85	70	105	2,5	4	M6
FT 100	100	80	120	3	4	M6
FT 100	100	80	120	3	4	M6
FT 115	115	95	140	3	4	M8
FT 115	115	95	140	3	4	M8
FT 115	115	95	140	3	4	M8
FT 130	130	110	160	3,5	4	M8
FT 130	130	110	160	3,5	4	M8
FT 130	130	110	160	3,5	4	M8
FT 130	130	110	160	3,5	4	M8
FT 215	215	180	250	4	4	M12
FT 215	215	180	250	4	4	M12
FT 215	215	180	250	4	4	M12
FT 215	215	180	250	4	4	M12

* LB1: non-ventilated motor

Type	Main dimensions							
	AC	LB	LB1*	HJ	LJ	J	I	II
LS 56 M	110	156	134	84	16	86	43	43
LS 63 M	124	172	165	89	26	86	43	43
LS 71 L	140	193	166	99	26	86	43	43
LS 80 L	170	215	177	123	26	86	43	43
LS 80 LU	170	267	232	123	26	86	43	43
LS 90 S	190	218	177	133	26	86	43	43
LS 90 L/SL	190	245	204	133	26	86	43	43
LS 90 LU	190	265	230	133	26	86	43	43
LS 100 L	200	290	250	138	26	86	43	43
LS 112 M	200	290	250	138	26	86	43	43
LS 112 MG	235	315	265	148	36	86	43	43
LS 112 MU	235	334	288	148	36	86	43	43
LS 132 S	235	350	306	148	53	86	43	43
LS 132 SM/M	280	387	327	175	25	110	57	73
LS 132 MU	280	410	351	175	25	110	57	73
LS 160 MP	315	425	407	208	70	110	57	73
LS 160 LR	315	495	440	208	70	110	57	73

Dimension CA and shaft extension dimensions are identical to those for foot mounted motors (page 104).

3-phase TEFV induction motors LS aluminium alloy frame Optional features

G1 - Non-standard flanges

Optionally, LEROY-SOMER motors can be fitted with flanges and faceplates that are larger or smaller than standard. This means that motors can be adapted to all types of situation without the need for costly and time-consuming modifications.

The tables below give flange and faceplate dimensions and flange/motor compatibility.

The bearing and shaft extension for each frame size remain standard.

MAIN FLANGE DIMENSIONS

Flange mounted (FF)

Dimensions in millimetres

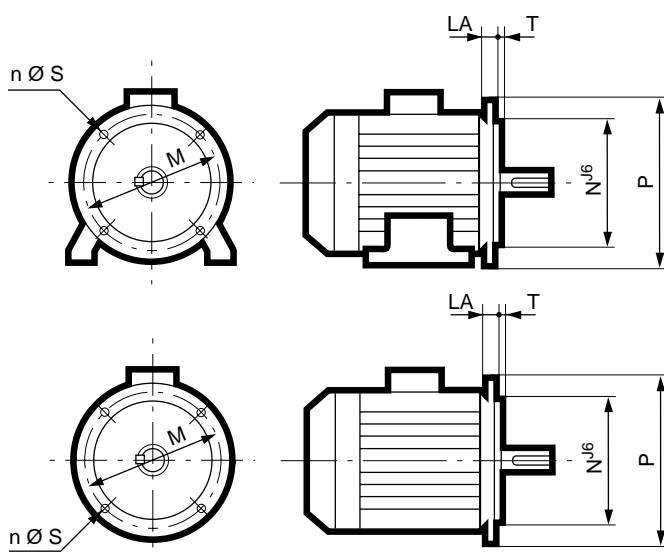

IEC symbol	Flange dimensions						
	M	N	P	T	n	S	LA
FF 100	100	80	120	2.5	4	7	5
FF 115	115	95	140	3	4	10	10
FF 130	130	110	160	3.5	4	10	10
FF 165	165	130	200	3.5	4	12	10
FF 215	215	180	250	4	4	15	12
FF 265	265	230	300	4	4	15	14
FF 300	300	250	350	5	4	18.5	14
FF 350	350	300	400	5	4	18.5	15
FF 400	400	350	450	5	8	18.5	16
FF 500	500	450	550	5	8	18.5	18
FF 600*	600	550	660	6	8	24	22

* Tolerance Njs⁶

Face mounted (FT)

Dimensions in millimetres

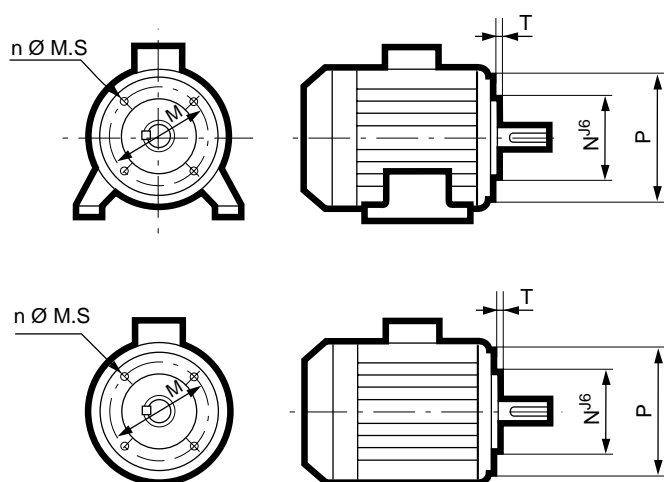

IEC symbol	Faceplate dimensions					
	M	N	P	T	n	M.S
FT 65	65	50	80	2.5	4	M5
FT 75	75	60	90	2.5	4	M5
FT 85	85	70	105	2.5	4	M6
FT 100	100	80	120	3	4	M6
FT 115	115	95	140	3	4	M8
FT 130	130	110	160	3.5	4	M8
FT 165	165	130	200	3.5	4	M10
FT 215	215	180	250	4	4	M12
FT 265	265	230	300	4	4	M12

3-phase TEFV induction motors LS aluminium alloy frame Optional features

G1 - Non-standard flanges

Motor type	Flange mounted (FF)											Face mounted (FT)										
	Flange type	FF 100	FF 115	FF 130	FF 165	FF 215	FF 265	FF 300	FF 350	FF 400	FF 500	FF 600	FT 65	FT 75	FT 85	FT 100	FT 115	FT 130	FT 165	FT 215	FT 265	
LS 56		●											●	*	*	*						
LS 63		○	●	*									*	●	*	*	*					
LS 71		○	○	●	○								*	*	●	*	*	*				
LS 80			○	○	●	*									*	●	*	*	*			
LS 90			*	*	●	*										*	●	*	○			
LS 90 (Foot)			○	○	○	○										*	●	*	○			
LS 100			○	○	○	●											*	●	*	*	*	
LS 112 M			○	○	○	●											*	●	*	*	*	
LS 112 MG				○	○	●	*										*	●	*	*	*	
LS 132 S					○	*	●											*	*	●	*	
LS 132 SM/MMU					○	○	●	○											*	●	*	*
LS 160 MP/LR						*	*	●	*											●	*	*
LS 180								●	*													*
LS 200								*	●	*												
LS 225									●	*												
LS 250									*	●												
LS 280										●	*											
LS 315										*	●											

● Standard ○ Modified bearing location * Adaptable without modification ■ : non-standard

G2 - Drip covers

Dimensions in millimetres

Drip cover for operation in vertical position, shaft end facing down

Type	LB'	Ø
80	LB + 20	145
90	LB + 20	185
100	LB + 20	185
112 M	LB + 20	185
112 MG	LB + 25	210
132 S	LB + 25	210
132 SM and M	LB + 30	240
160 MP-LR	LB + 30	240
160 M-L-LU	LB + 36.5	265
180 MT-LR	LB + 36.5	265
180 L/LU	LB + 36.5	305
200 LT	LB + 36.5	305
200 L-LU	LB + 36.5	350
225 ST-MT-MR	LB + 36.5	350
225 MG	LB + 55	420
250 MZ	LB + 36.5	350
250 ME-MF	LB + 55	420
280 SC/SD/MC/MD	LB + 55	420
280 SK-MK	LB + 76.5	505
315 SP-MP-MR	LB + 76.5	505

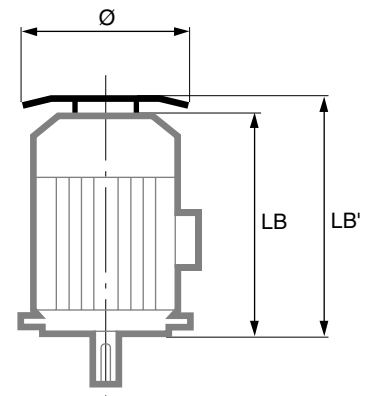

3-phase TEFV induction motors LS aluminium alloy frame Optional features

G3 - Options

G3.1 - LS MOTORS WITH OPTIONAL FEATURES

The integration of LS motors within a process often requires accessories to make operation easier:

- **D.C. tachometers** recommended for slip compensation.
- **A.C. tachometers** for speed measurement.
- **forced ventilation** for motors used at high or low speeds.

- **holding brakes** for maintaining the rotor in the stop position without needing to leave the motor switched on.

- **emergency stop brakes** to immobilise loads in case of failure of the motor torque control or loss of power supply.

- **encoders** which provide digital information for accurate speed maintenance and position control.

These options can be used singly or in combination as shown in the table opposite.

Notes:

- Without forced ventilation, there is a possibility of overspeed with class "S" balancing.
- The motor temperature is monitored by probes built into the windings.

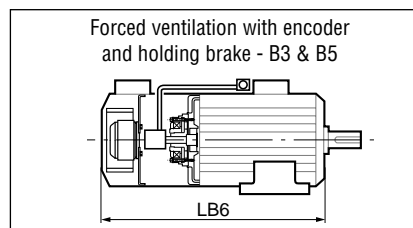
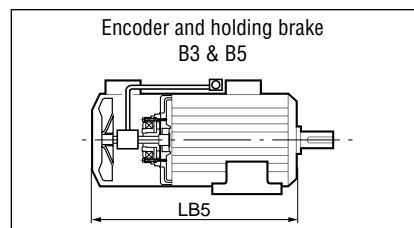
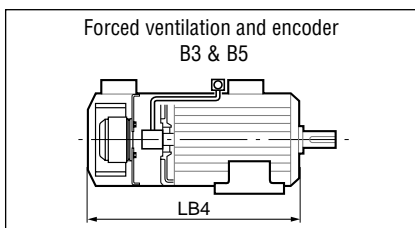
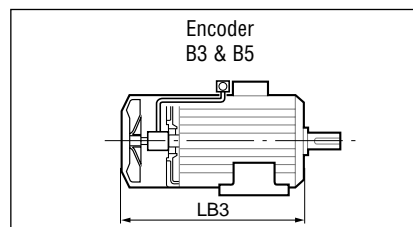
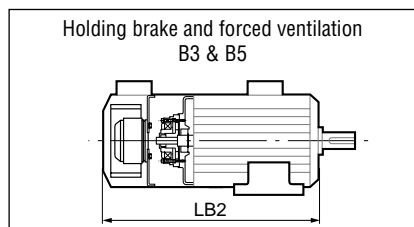
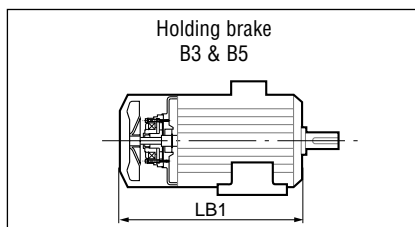

3-phase TEFV induction motors LS aluminium alloy frame Optional features

G3 - Options

G3.2 - DIMENSIONS OF LS MOTORS WITH OPTIONAL FEATURES

Dimensions in millimetres

Type	Main dimensions LBn					
	LB1	LB2	LB3	LB4	LB5	LB6
LS 80 L	251	340	295	351	359	415
LS 90 S	276	335	○	○	○	○
* LS 90 L	302	362	328	383	375	430
LS 100 L	354	395	376	431	440	495
LS 112 M	354	395	376	431	440	495
LS 112 MG	380	455	396	443	459	497
LS 132 S	400	445	○	○	○	○
LS 132 SM	447	482	461	499	535	573
LS 132 MU	○	○	486	524	560	598
LS 160 M	-	-	549	687	-	-
LS 160 L	-	-	549	687	-	-
LS 160 LU	-	-	564	702	-	-
LS 180 MT	-	-	549	687	-	-
LS 180 LR	-	-	564	702	-	-
LS 180 L	-	-	602	741	-	-
LS 180 LU	-	-	629	769	-	-
LS 200 LT	-	-	635	775	-	-
LS 200 L	-	-	674	802	-	-
LS 200 LU	-	-	723	847	-	-
LS 225 ST	-	-	681	808	-	-
LS 225 SR	-	-	730	854	-	-
LS 225 MR	-	-	730	854	-	-
LS 225 MG	-	-	860	1012	-	-
LS 250 MZ	-	-	730	-	-	-
LS 250 ME	-	-	860	1012	-	-
LS 280 SC	-	-	860	1012	-	-
LS 280 MD	-	-	920	1072	-	-
LS 280 MK	-	-	965	1075	-	-
LS 315 SP/MP	-	-	991	1101	-	-
LS 315 MR	-	-	1061	1171	-	-

- : not available

○ : please consult Leroy-Somer

* For B5, add 20 mm

Description of options

The dimensions and characteristics of the various options described are available in the LS MV motor catalogues.

3-phase TEFV induction motors LS aluminium alloy frame Optional features

G4 - Safety

The elimination of risk for operators of all types of equipment is one of the priority areas in workplace safety.

Companies can do their best by perfecting their processes and procedures to make them safer and by introducing a safety element into their training courses, but none of this is any good if there is no suitably safe equipment on the market.

Progress has been made in this area. Manufacturers, users, standards institutions and government departments have all played a part in improving safety in the workplace.

Leroy Somer has developed with certain customers complete motor packages incorporating a variety of safety features.

Typically, some of the main options that have been used are:

Symbol	Safety options	Details
RF	Decelerator - Electromechanical brake	5 types: 5 decelerating torques RF 3 - C = 3 mN RF 5 - C = 5 mN RF 32 - C = 32 mN RF 10 - C = 10 mN RF 16 - C = 16 mN
DF	Decelerator/brake electrically released when machine stopped	Reversing switch prevents motor starting when brake is not applied.
PTO	Overload protection	Bimetal temperature probe in series with the contactor coil.
DIS	Protection against jamming and short-circuits	Isolating switch with fixed setting for each motor (0.35 to 7.5 kW).
TL	Red indicator light	Shows machine is switched on.
LC	Supply and protection switch: - protects against overload (used with PTO) - prevents uncontrolled starts	Single voltage power switch: 2 standard types - 230V: LC 220 Other voltages on request - 400V: LC 380
VS	Key lock to prevent machine starting	LC is controlled by: - a pushbutton for starting - a mushroom head button with VS emergency stop option
ET	Star-delta starter	Starter switch with timer, downstream of LC .
A	Load ammeter	2 coloured zones on meter: - green: continuous duty - red: overload - intermittent duty

3-phase TEFV induction motors LS aluminium alloy frame Optional features

G4 - Safety

No.	Main option combinations	Additional combinable options	References*		
			Sbb	Mbb	Lbb
1	- Decelerator - brake: RF... - 4 types: RF3, RF5, RF10, RF16	PTO DF	● ●		
2	- D.O.L. starting: LC... - 1 supply voltage: LC 220 or LC 380 - Control on right: LC.../d - Control on left: LC.../g	A PTO VS TL DIS		● ● ● ●	●
3 (2 + ET)	- Star-delta starting: LC... - ET - Control on right: LC... - ET/d - Control on left: LC... - ET/g	PTO VS A or DIS TL			● ● ● ●
4 (1 + 2)	- Decelerator - brake + D.O.L. starting : RF... - LC... - Control on right: RF... - LC.../d - Control on left: RF... - LC.../g	PTO VS DF or A or DIS TL			● ● ● ●
5 (1 + 3)	- Decelerator - brake + Star-delta starting : RF... - LC... - ET - Control on right: RF... - LC... - ET/d - Control on left: RF... - LC... - ET/g	PTO VS DF or A or DIS TL			● ● ● ●

* Dimensions (see following page).

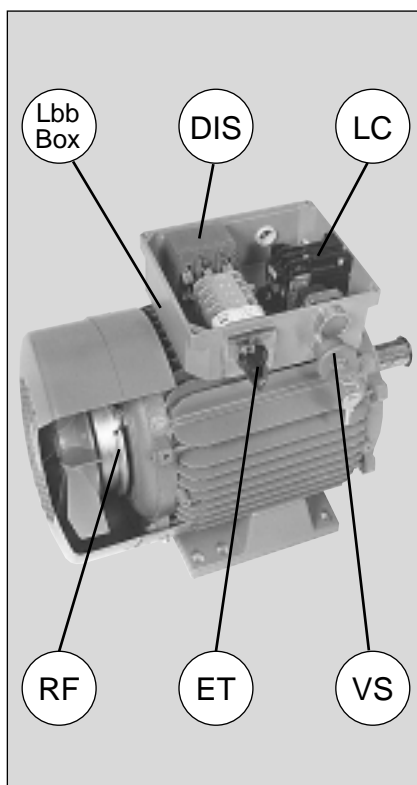

3-phase TEFV induction motors LS aluminium alloy frame Optional features

G4 - Safety

Devices for motors with optional safety features

Dimensions in millimetres

Sbb

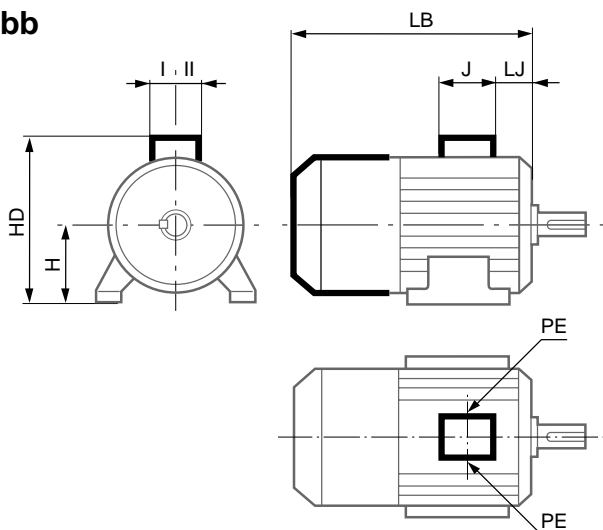

- Terminal box with cable gland on right or left
(as seen from drive end)

MOTOR TYPES								
Ref.	LS 80	LS 90S	LS 90L	LS 100	LS 112 M	LS 112 MG	LS 132 S	LS 132 M
LB	251	276	302	354	354	380	400	447
J	137	137	137	137	137		137	160
LJ	25	25	25	32	35		53	25
HD	224	244	244	259	280		300	313
H	80	90	90	100	112		132	132
I	51.5	51.5	51.5	51.5	51.5		51.5	55
II	51.5	51.5	51.5	51.5	51.5		51.5	55.5

Mbb

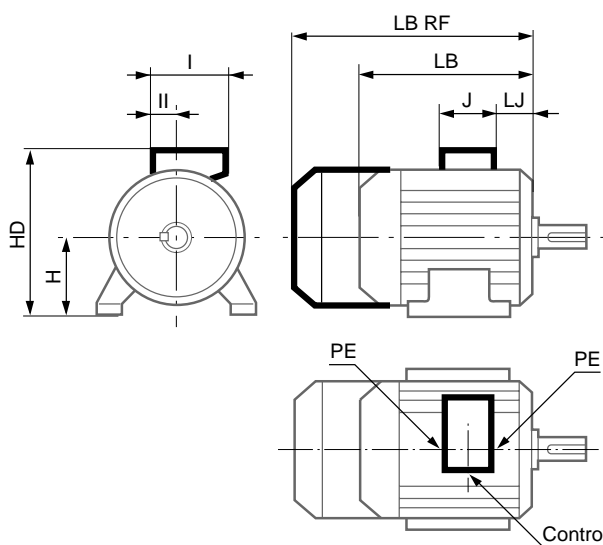

- Reversible terminal box with cable gland on fan cover side
(as seen from drive end)

MOTOR TYPES								
Ref.	LS 80	LS 90S	LS 90L	LS 100	LS 112 M	LS 112 MG	LS 132 S	LS 132 M
LB	214	218	245	290	290	315	350	-
LB RF	251	276	302	354	354	380	400	-
J	109	109	109	109	109		109	-
LJ	17.5	17.5	17.5	24.5	27.5		45.5	-
HD	247	267	267	282	303		323	-
H	80	90	90	100	112		132	-
I	143	143	143	143	143		143	-
II	51	51	51	51	51		51	-

Lbb

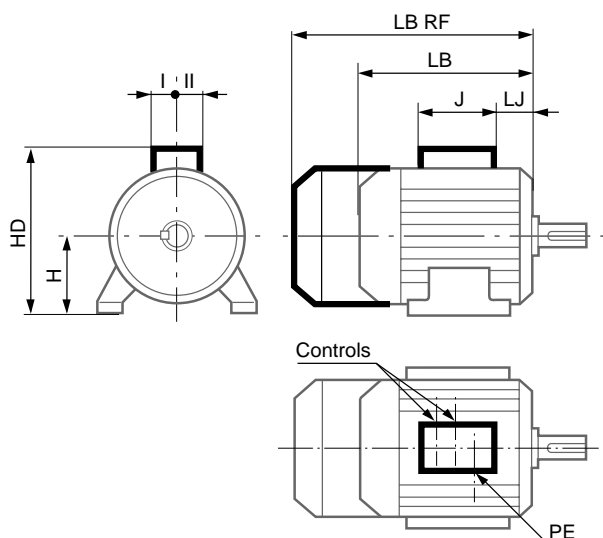

- 1 terminal box with cable gland on right, controls on left
- 1 terminal box with cable gland on left, controls on right
(as seen from drive end)

MOTOR TYPES								
Ref.	LS 80	LS 90S	LS 90L	LS 100	LS 112 M	LS 112 MG	LS 132 S	LS 132 M
LB	214	218	245	290	290	315	350	387
LB RF	251	276	302	354	354	380	400	447
J	194	194	194	194	194		194	194
LJ	17.5	17.5	17.5	24.5	27.5		45.5	24
HD	247	266	266	281	302		322	334
H	80	90	90	100	112		132	132
I	78.5	78.5	78.5	78.5	78.5		78.5	78.5
II	78.5	78.5	78.5	78.5	78.5		78.5	78.5

3-phase TEFV induction motors LS aluminium alloy frame Installation and maintenance

H1 - Voltage drop along cables (standard NFC 15 100)

Voltage drops are calculated using the formula:

$$u = b \left(\rho_1 \frac{L}{S} \cos \varphi + \lambda L \sin \varphi \right) I_s$$

where u = voltage drop

b = factor equal to 1 for three-phase circuits, and equal to 2 for single-phase circuits

Note: Three-phase circuits with a neutral that is completely out of balance (loss of two phases) are treated as single-phase circuits.

ρ_1 = resistivity of the conductors in normal duty taken as being equal to the resistivity at the normal duty temperature, ie. 1.25 times the resistivity at 20 °C, giving 0.0225 $\Omega\text{mm}^2/\text{m}$ for copper and 0.036 $\Omega\text{mm}^2/\text{m}$ for aluminium.

L = length of cabling conduits in metres

S = cross-section of conductors in mm^2

$\cos \varphi$ = Power Factor: if the exact figure is not available, the PF is taken as being 0.8 ($\sin \varphi = 0.6$)

λ = linear reactance of conductors, taken as being equal to 0.08 $\text{m}\Omega / \text{m}$ if the exact figure is not available

I_s = current in use, in amps

The higher the current, the greater the voltage drop will be. The voltage drop should therefore be calculated for the starting current to see if this is suitable for the application. If the most important

criterion is the starting torque (or starting time), the voltage drop should be limited to 3% maximum* (the equivalent of a loss of torque of around 6 to 8%).

* the relative voltage drop (as a %) equals:

$$\Delta u = 100 \frac{u}{U_0}$$

U_0 = voltage between phase and neutral

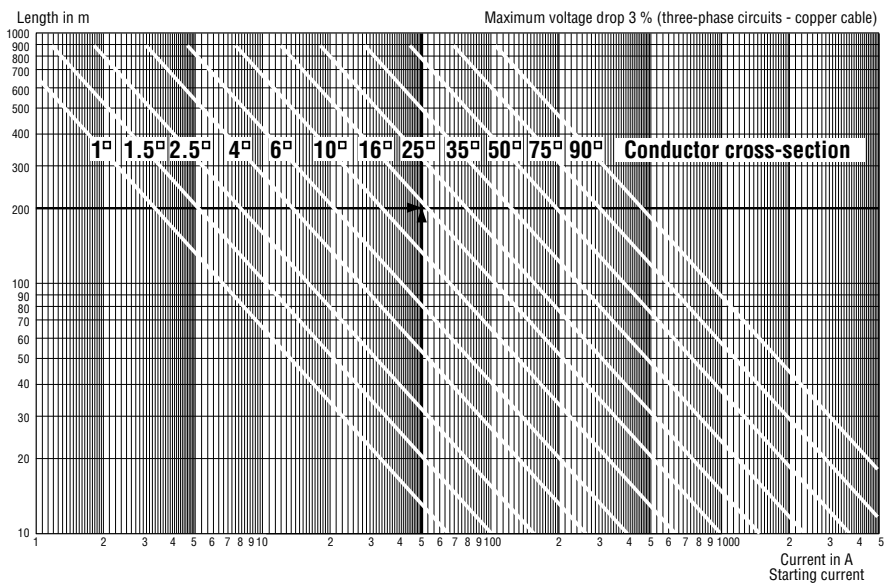

Maximum power for D.O.L. motors

The table opposite shows maximum kW ratings for D.O.L. motors connected to the mains supply.

Minimising motor starting problems

For the installation to remain in good working order, it is necessary to avoid any significant temperature rise in the cabling conduits, while making sure that the protection devices do not interrupt starting.

Operating problems in other equipment connected to the same supply are due to the voltage drop caused by the current demand on starting, which can be many times greater than the current absorbed by the motor at full load.

▼ Maximum power for D.O.L. motors (kW)

Type of motor	Single-phase 230 (220) V	Three-phase (380/400V)	
		full power D.O.L.	other starting methods
Type of premises			
Residential areas	1.4	5.5	11
Other premises } Overhead power lines	3	11	22
	5.5	22	45

Other premises includes the service sector, the industrial sector, general housing services, the agricultural sector, etc.

For motors driving a high inertia machine, motors with long starting times, brake motors or change of direction by current reversal, the electricity supply company must carry out all the necessary checks before installation.

3-phase TEFV induction motors LS aluminium alloy frame Installation and maintenance

H2 - Earthing impedance

French government decree 62.1454 of 14 November 1962 concerning the protection of operatives in workplaces in which electrical currents are used, requires that when the neutral is connected to the earth by a limiting impedance, the rms value of the fault current multiplied by the resistance of the earth terminal of the mass in which the fault occurs must not exceed:

- 24 V in highly conductive workplaces
- 50 V in other cases

(Ref. standard UTE C 12.100 - page 12, Article 32)

This may be written:

$$v = R'i$$

and $V = (Z + R + R' + r) i$

whence $Z = R' \frac{V}{v} - (R + R' + r)$

and consequently:

$$Z \geq R' \frac{V}{v_L} - (R + R' + r)$$

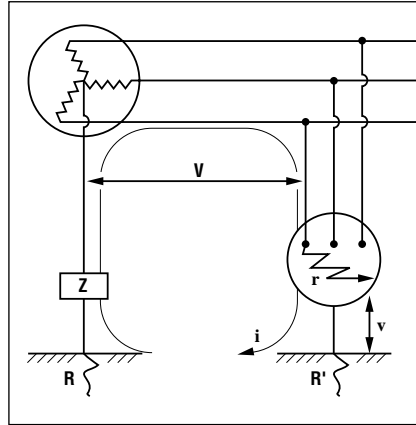

- V : simple voltage
- Z : limiting impedance
- R : resistance of neutral earth
- R' : resistance of the earth of the mass where the fault occurs
- r : internal fault resistance
- i : fault current
- v : potential of the mass in relation to the earth
- v_L : maximum value imposed for that potential

Example 1

Highly conductive premises where:

$$R = 3 \Omega$$

$$R' = 20 \Omega$$

$$r = 10 \Omega$$

$$V = 220 \text{ V}$$

$$Z \geq 20 \times \frac{220}{24} - (3 + 20 + 10) = 150 \Omega$$

Example 2

Other cases:

$$R = 6 \Omega$$

$$R' = 10 \Omega$$

$$r = 0 \Omega$$

$$V = 380 \text{ V}$$

$$Z \geq 10 \times \frac{380}{50} - (6 + 10 + 0) = 60 \Omega$$



3-phase TEFV induction motors LS aluminium alloy frame Installation and maintenance

H3 - Packaging weights and dimensions

Dimensions in millimetres

Frame size	ROAD TRANSPORT			
	IM B3		IM B5 - IM V1	
	Tare (kg)	Dimensions in mm (L x W x H)	Tare (kg)	Dimensions in mm (L x W x H)
<i>Cardboard boxes</i>				
56	0.3	230 x 120 x 170	0.3	230 x 120 x 170
63	0.3	230 x 120 x 170	0.3	230 x 120 x 170
71	0.4	305 x 155 x 170	0.4	305 x 155 x 170
80	0.7	330 x 205 x 255	0.7	330 x 205 x 255
90	0.85	375 x 215 x 285	0.85	375 x 215 x 285
100	1.25	420 x 270 x 320	1.25	420 x 270 x 320
112	1.25	420 x 270 x 320	1.25	420 x 270 x 320
132	2.9	560 x 320 x 375	2.9	560 x 320 x 375
160	8	710 x 500 x 570	8	710 x 500 x 570
<i>Open pallet box or laths</i>				
160	17	740 x 480 x 610	18	740 x 480 x 610
180	17	740 x 480 x 610	18	740 x 480 x 610
200	38	890 x 570 x 710	35	890 x 570 x 710
225	56	1000 x 870 x 720	48	1000 x 870 x 720
<i>Pallets</i>				
250	18	1000 x 600	22	1000 x 600
280	20	1200 x 700	24	1200 x 700
315	20	1200 x 700	24	1200 x 700

Frame size	SEA TRANSPORT			
	IM B3		IM B5 - IM V1	
	Tare (kg)	Dimensions in mm (L x W x H)	Tare (kg)	Dimensions in mm (L x W x H)
<i>Plywood crates</i>				
56	on request		on request	
63	on request		on request	
71	on request		on request	
80	on request		on request	
90	on request		on request	
100	17	740 x 480 x 610	18	740 x 480 x 610
112	17	740 x 480 x 610	18	740 x 480 x 610
132	17	740 x 480 x 610	18	740 x 480 x 610
160	17	740 x 480 x 610	18	740 x 480 x 610
160	17	740 x 480 x 610	18	740 x 480 x 610
180	17	740 x 480 x 610	18	740 x 480 x 610
200	48	910 x 620 x 750	50	910 x 620 x 750
225	55	960 x 750 x 830	57	960 x 750 x 830
250	77	1120 x 750 x 890	82	1120 x 750 x 890
280	86	1270 x 720 x 970	90	1270 x 720 x 970
315	86	1270 x 720 x 970	90	1270 x 720 x 970

- These values are given for individual packages
- Frame sizes up to 132 grouped in cardboard containers on a standard 1200 x 800 pallet

3-phase TEFV induction motors LS aluminium alloy frame Installation and maintenance

H4 - Position of lifting rings

Position of lifting rings for lifting the motor only (not connected to the machine)

Labour regulations in France stipulate that all loads over 25 kg must be fitted with lifting devices to facilitate handling.

The positions of the lifting rings and the

minimum dimensions of the loading bars are given below in order to help with preparation for handling the motors. If these precautions are not followed, there is a risk of warping or crushing some equipment such as the terminal box, protective cover or drip cover.

IMPORTANT: motors intended for use in the vertical position may be delivered in the horizontal position on a pallet. When the motor is pivoted, the shaft must under no circumstances be allowed to touch the ground, as the bearings may be irreparably damaged.

- horizontal position

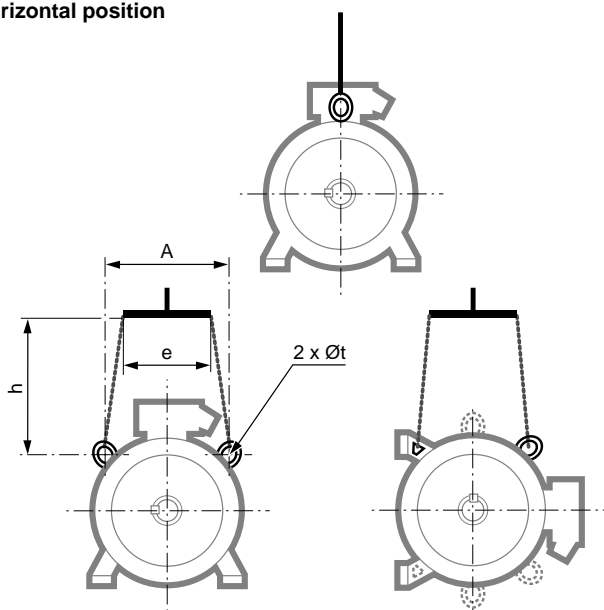

Type	Horizontal position			
	A	e min	h min	Øt
112 MG/MU	120	200	150	9
132	160	200	150	9
160	200	160	110	14
180 MR	200	160	110	14
180 L	200	260	150	14
200	270	260	165	14
225 ST/MT	270	260	150	14
225 MG	400	400	500	30
250 ME/MF	400	400	500	30
280 SC/MC/MD	400	400	500	30
280 SK/MK	360	380	500	30
315 SP/MP/MR	360	380	500	17

- vertical position

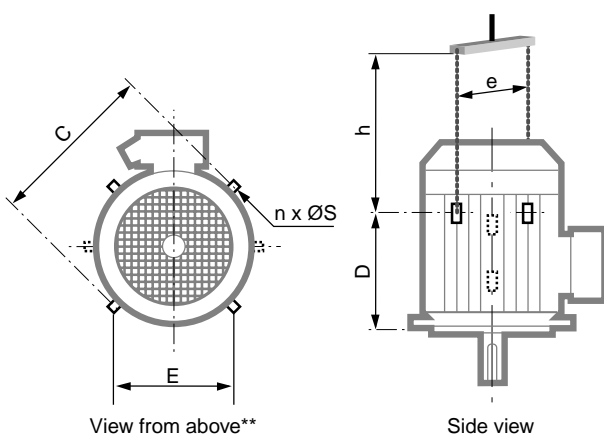

Type	Vertical position						
	C	E	D	n**	ØS	e min*	h min
160	320	200	230	2	14	320	350
180 MR	320	200	230	2	14	320	270
180 L-LU	390	265	290	2	14	390	320
200 L-LU	410	300	295	2	14	410	450
225 ST/MT/MR	410	300	295	2	14	410	450
225 MG	500	400	502	4	30	500	500
250 MZ	410	300	295	2	14	410	450
250 ME/MF	500	400	502	4	30	500	500
280 SC/SD/MC/MD	500	400	502	4	30	500	500
280 SK/MK	630	-	570	2	30	630	550
315 SP/MP/MR	630	-	570	2	30	630	550



*: if the motor is fitted with a drip cover, allow an additional 50 to 100 mm to avoid damaging it when the load is swung.



** : if $n = 2$, the lifting rings form an angle of 90° with respect to the terminal box axis
if $n = 4$, this angle becomes 45°

3-phase TEFV induction motors LS aluminium alloy frame Installation and maintenance

H5 - Identification, exploded views and parts list

H5.1 - NAMEPLATES

 Mot. ~ LS 90L - T N° 999999 JJ0001							
IP55	IK08	cl.F	°C	S.S1	kg 18		
	V	Hz	min ⁻¹	kW	cos φ	A	
λ	380	50	1420	1.50	0.83	3.70	
Δ	230	50	1430	1.50	0.81	6.20	
λ	400	50	1430	1.50	0.81	3.60	
λ	415	50	1435	1.50	0.79	3.60	
λ	440	60	1710	1.80	0.85	3.60	
λ	460	60	1720	1.80	0.83	3.50	

 MOT. 3 ~ LS 225 MR T N° 125089HA001							
IP55	IK08	I cl.F	40°C	S1			
	V	Hz	min ⁻¹	kW	cos φ	A	
Δ	380	50	1462	45	0.85	87.1	
Δ	400	-	1468	-	0.84	83.3	
Y	690	-	1468	-	0.84	48.3	
Δ	415	-	1470	-	0.82	82.2	
Δ	440	60	1758	52	0.86	85.5	
Δ	460	-	1764	-	0.85	82.4	
DE	6313 C3		25	g	ESSO UNIREX N3		
NDE	6312 C3		5000	h			

*Other logos may be used as an option, but only by agreement BEFORE ordering

▼ Definition of symbols used on nameplates

 Legal mark of conformity of product to the requirements of European Directives.

MOT 3 ~ : Three-phase A.C. motor
LS : Range
132 : Frame size
M : Housing symbol
T : Impregnation index

Motor no.

125089 : Serial number
H : Year of production
A : Month of production
001 : Batch number

 : Efficiency indicator

IP55 IK08: Index of protection
I cl. F : Insulation class F
40°C : Contractual ambient operating temperature
S...% : Duty - Duty (operating) factor
c/h : Number of cycles per hour
kg : Weight
V : Supply voltage
Hz : Supply frequency
min⁻¹ : Revolutions per minute (rpm)
kW : Rated output power
cos φ : Power factor
A : Rated current
Δ : Delta connection
Y : Star connection

Bearings

DE : Drive end bearing
NDE : Non drive end bearing
g : Amount of grease at each regreasing (in g)
h : Regreasing interval (in hours)
ESSO UNIREX N3 : Type of grease

Please quote when ordering
spare parts

3-phase TEFV induction motors LS aluminium alloy frame Installation and maintenance

H5 - Identification, exploded views and parts list

H5.2 - FRAME SIZE: 56 to 132

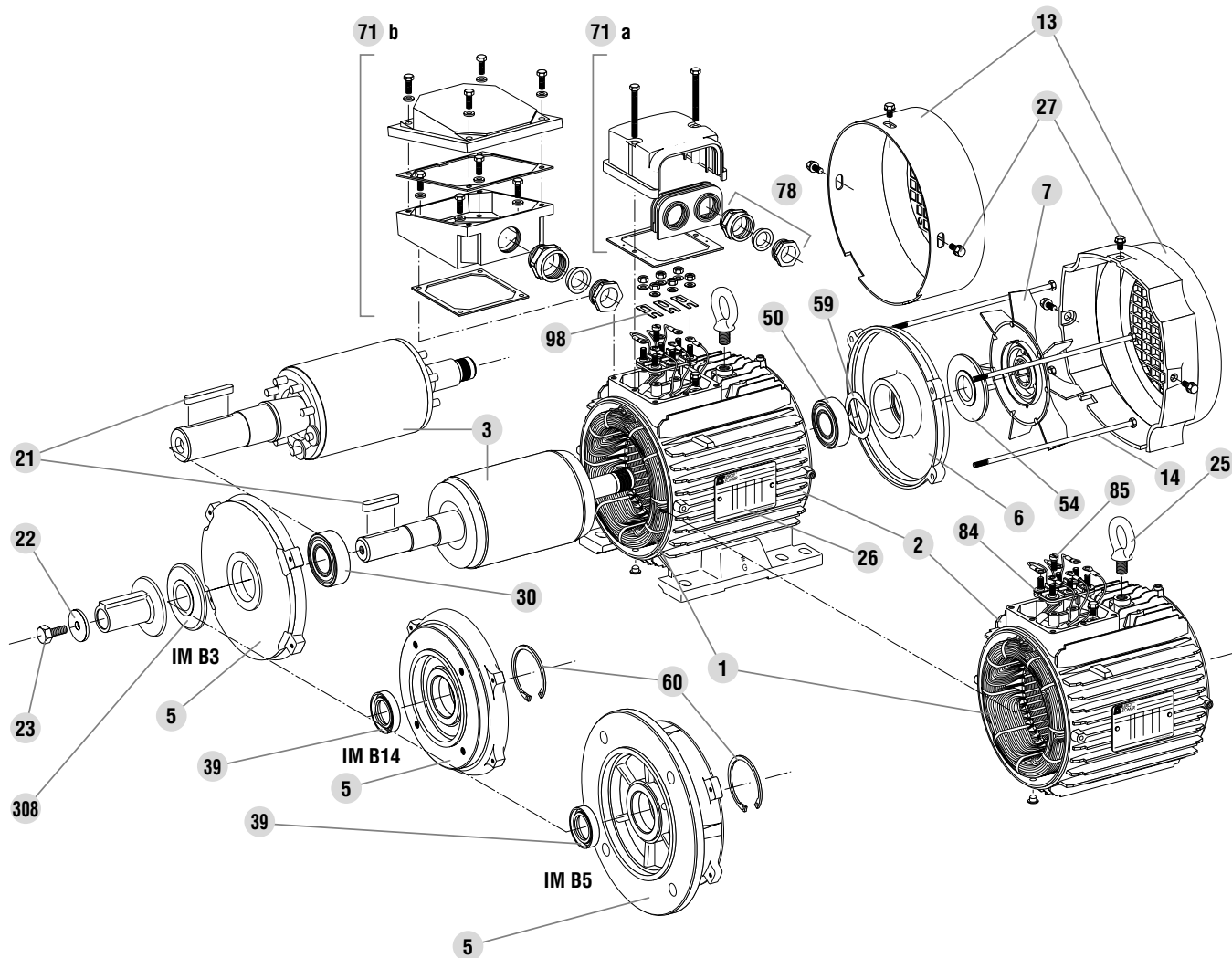

Frame size: 56 to 132

No,	Description	No,	Description	No,	Description
1	Wound stator	22	Shaft extension washer	59	Preloading (wavy) washer
2	Frame	23	Shaft extension screw	60	Circlip
3	Rotor	25	Lifting ring	71a	Plastic terminal box (up to frame 112)
5	DE shield	26	Nameplate	71b	Metal terminal box
6	NDE shield	27	Fan cover screw	78	Cable gland
7	Fan	30	Drive end bearing	84	Terminal block
13	Fan cover	39	Drive end seal	85	Set screw
14	Tie rods	50	Non drive end bearing	98	Connectors
21	Shaft extension key	54	Non drive end seal	308	Labyrinth seal

Note: The above illustration of parts does not necessarily show details, forms and volumes accurately.

3-phase TEFV induction motors LS aluminium alloy frame Installation and maintenance

H5 - Identification, exploded views and parts list

H5.3 - FRAME SIZE: 160 and 180

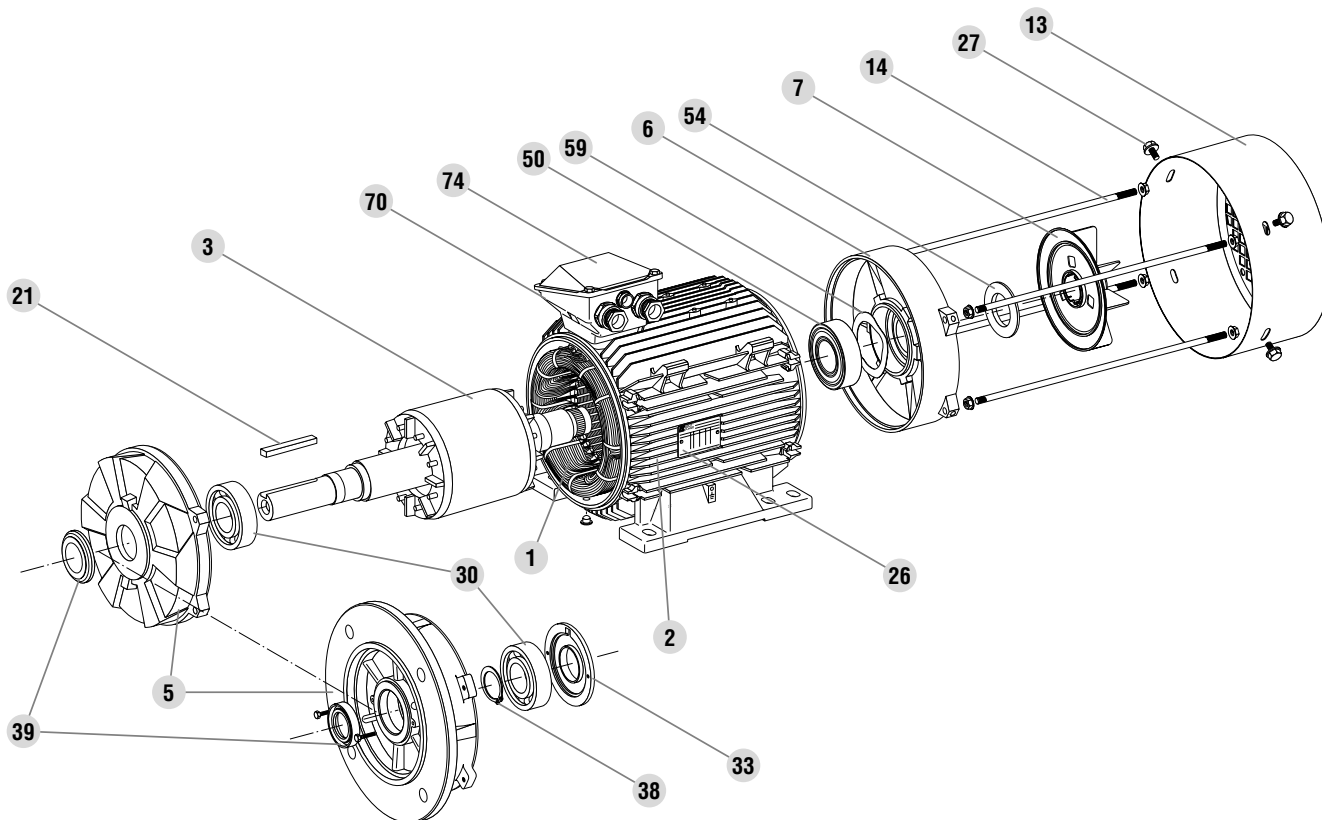

Frame size: 160 and 180

No.	Description	No.	Description	No.	Description
1	Wound stator	14	Tie rods	39	Drive end seal
2	Frame	21	Key	50	Non drive end bearing
3	Rotor	26	Nameplate	54	Non drive end seal
5	DE shield	27	Fan cover screw	59	Preloading (wavy) washer
6	NDE shield	30	Drive end bearing	70	Terminal box
7	Fan	33	Inner DE bearing retainer	74	Terminal box lid
13	Fan cover	38	Drive end bearing circlip		

Note: The above illustration of parts does not necessarily show details, forms and volumes accurately.

3-phase TEFV induction motors LS aluminium alloy frame Installation and maintenance

H5 - Identification, exploded views and parts list

H5.4 - FRAME SIZE: 200 and 225

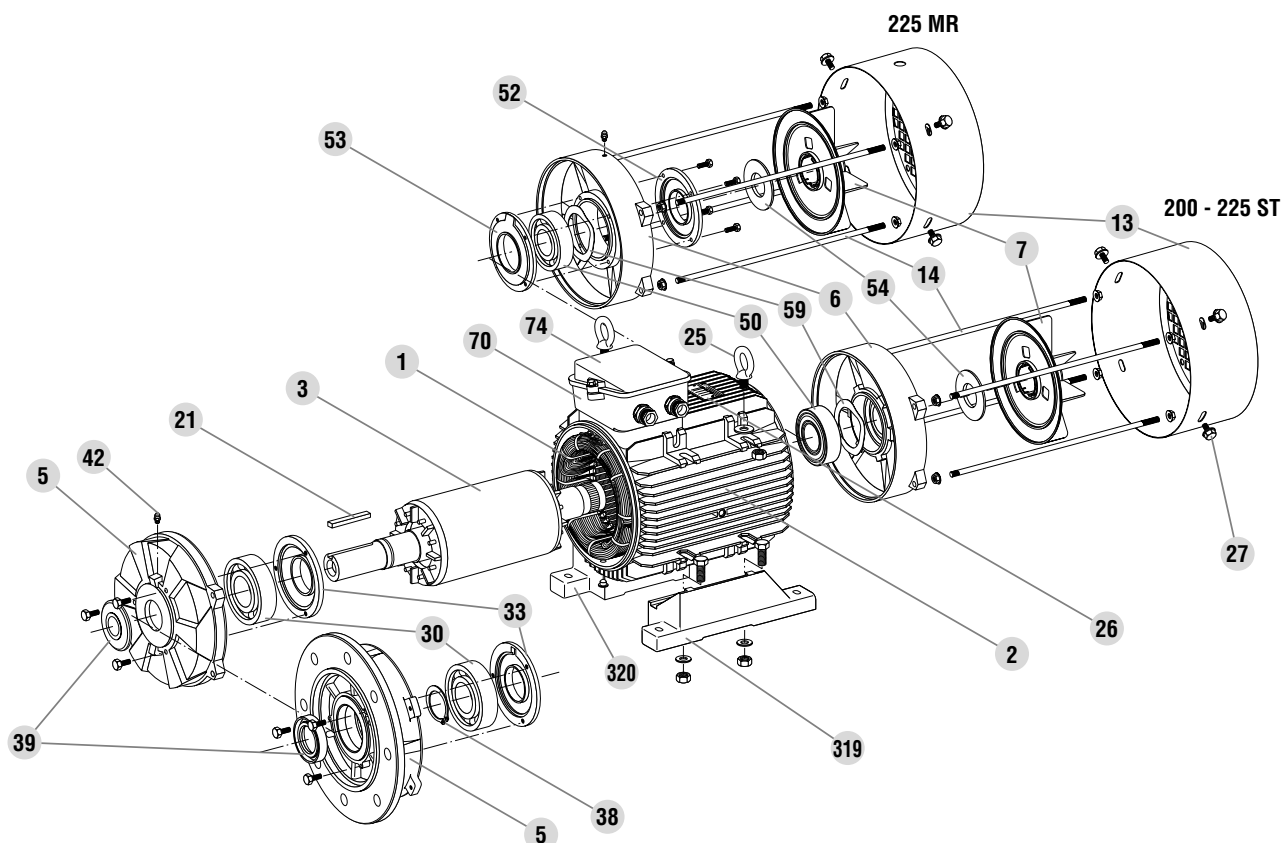

Frame size: 200 and 225

No.	Description	No.	Description	No.	Description
1	Wound stator	25	Lifting ring	52	Outer NDE bearing retainer
2	Frame	26	Nameplate	53	Inner NDE bearing retainer
3	Rotor	27	Fan cover screw	54	Non drive end seal
5	DE shield	30	Drive end bearing	59	Preloading (wavy) washer
6	NDE shield	33	Inner DE bearing retainer	70	Terminal box
7	Fan	38	Drive end bearing circlip	74	Terminal box lid
13	Fan cover	39	Drive end seal	319	Right foot
14	Tie rods	42	Grease nipples (optional for 200 frame)	320	Left foot
21	Key	50	Non drive end bearing		

Note: The above illustration of parts does not necessarily show details, forms and volumes accurately.

3-phase TEFV induction motors LS aluminium alloy frame Installation and maintenance

H5 - Identification, exploded views and parts list

H5.5 - FRAME SIZE: 250 and 280

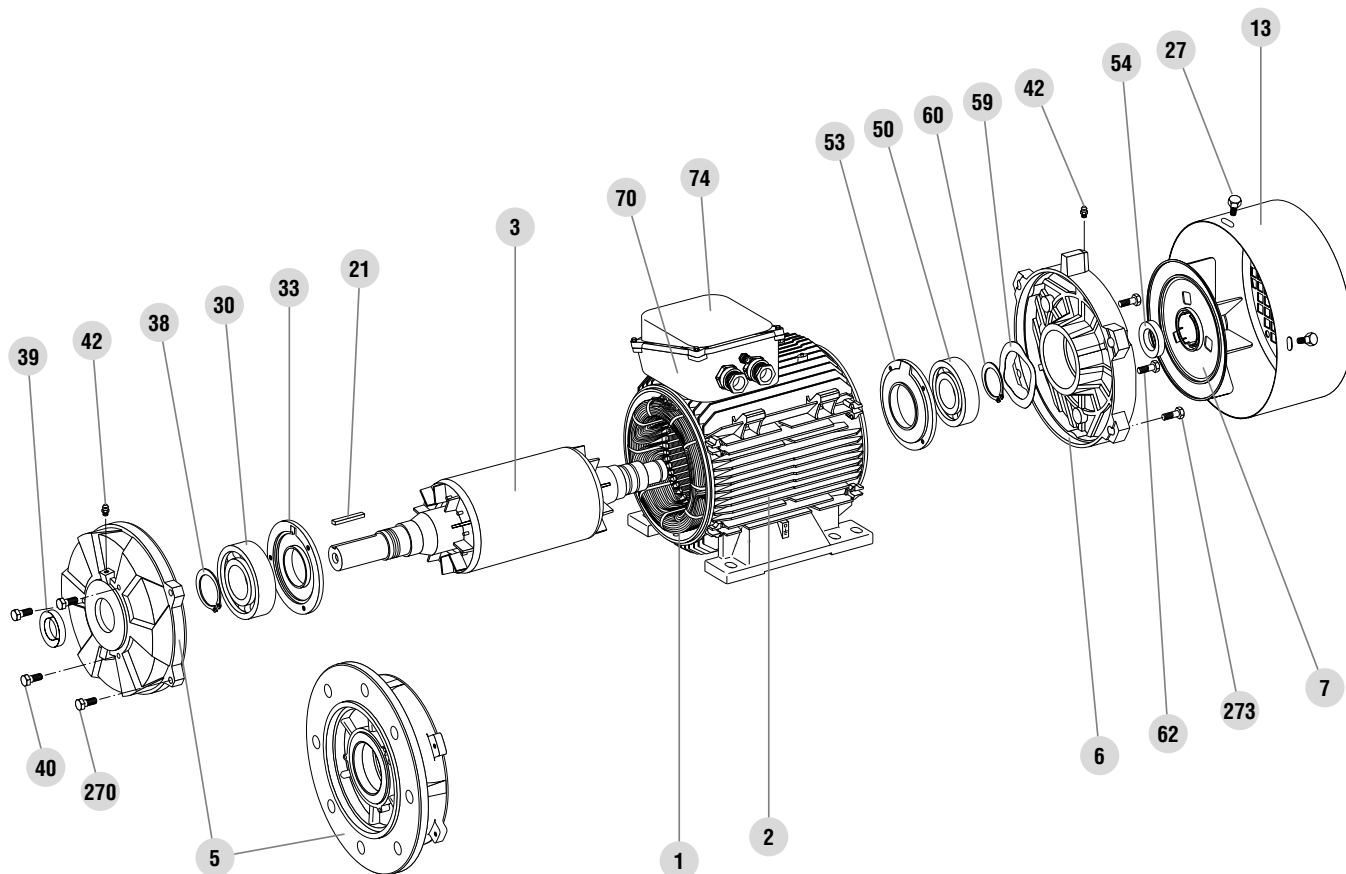

Frame size: 250 and 280

No.	Description	No.	Description	No.	Description
1	Wound stator	30	Drive end bearing	59	Preloading (wavy) washer
2	Frame	33	DE internal cover	60	Non drive end bearing circlip
3	Rotor	38	Drive end bearing circlip	62	Cover fixing screw
5	DE shield	39	Drive end seal	70	Terminal box
6	NDE shield	40	Cover fixing screw	74	Terminal box lid
7	Fan	42	Grease nipples	270	DE shield fixing screw
13	Fan cover	50	Non drive end bearing	273	NDE shield fixing screw
21	Shaft extension key	53	Inner NDE bearing retainer		
27	Fan cover screw	54	Non drive end seal		

Note: The above illustration of parts does not necessarily show details, forms and volumes accurately.

3-phase TEFV induction motors LS aluminium alloy frame Installation and maintenance

H5 - Identification, exploded views and parts list

H5.6 - FRAME SIZE: 315

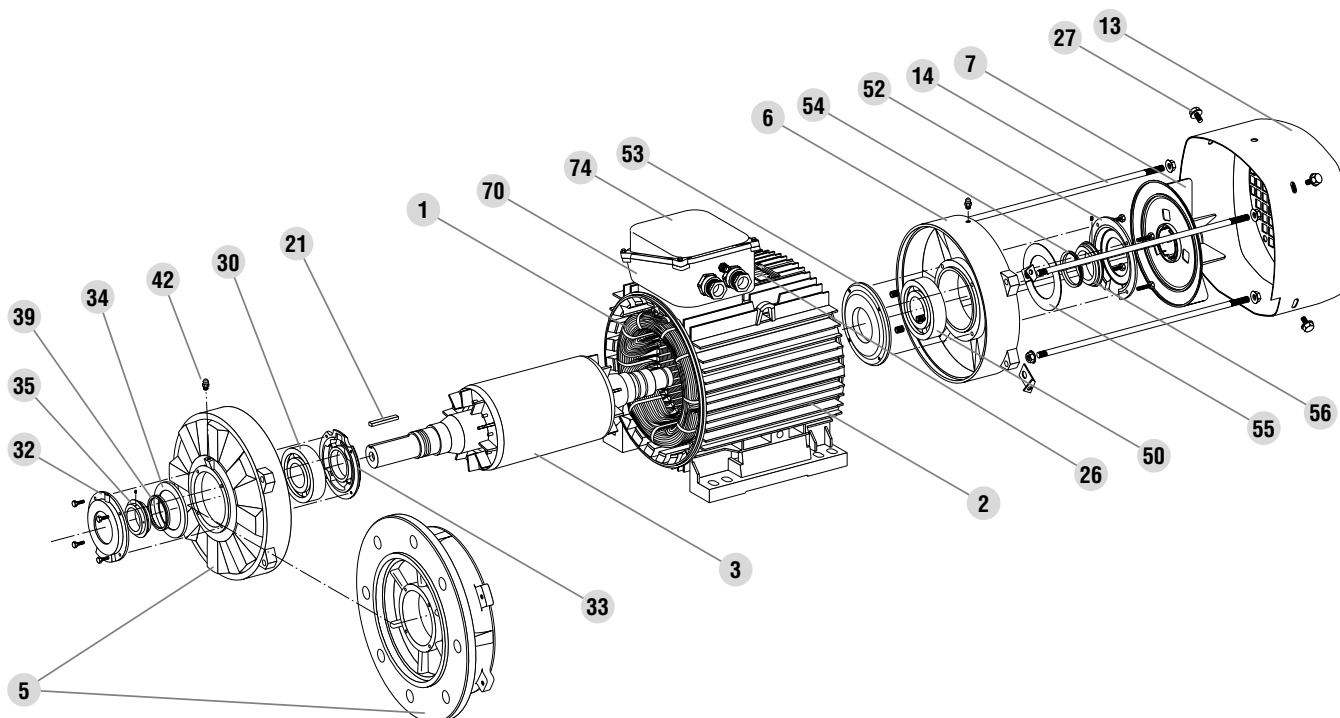

Frame size: 315

No.	Description	No.	Description	No.	Description
1	Wound stator	27	Fan cover screw	52	Outer NDE bearing retainer
2	Frame	30	Drive end bearing	53	Inner NDE bearing retainer
3	Rotor	32	Outer DE bearing retainer	54	Non drive end seal
5	DE shield	33	Inner DE bearing retainer	55	NDE fixed grease valve
6	NDE shield	34	DE fixed grease valve	56	NDE mobile grease valve
7	Fan	35	DE mobile grease valve	70	Terminal box
13	Fan cover	39	Drive end seal	74	Terminal box lid
14	Tie rods	42	Grease nipples		
21	Key	50	Non drive end bearing		

Note: The above illustration of parts does not necessarily show details, forms and volumes accurately.

3-phase TEFV induction motors LS aluminium alloy frame Installation and maintenance

H6 - Maintenance

LEROY-SOMER can provide installation and maintenance information on each type of product or product range.

These documents, plus other technical information on our products can be obtained on request from LEROY-SOMER sales offices.

When asking for informative material, you should quote the complete machine reference.

LEROY-SOMER, in its continuous search for ways to help our customers, has evaluated numerous methods of preventive maintenance.

The diagram and table below give the recommended equipment to use and the ideal positions to take measurements of all parameters which can affect the operation of the machine, such as eccentricity, vibration, state of bearings, structural problems, electrical problems, etc

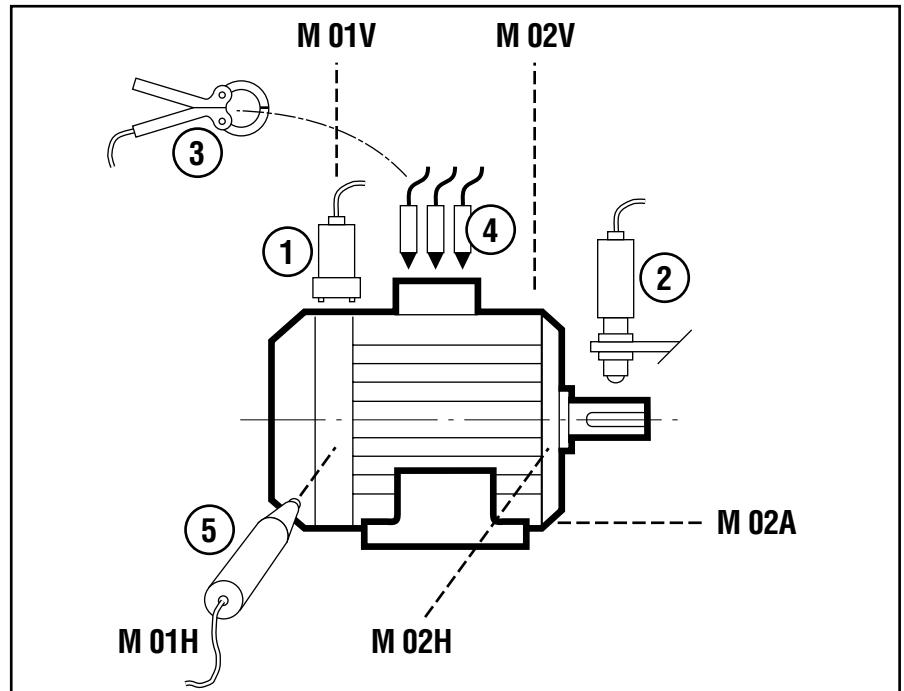

- ① Accelerometer: for measuring vibrations
- ② Photo-electric cell: for measuring speed and phase (balancing)
- ③ Clamp ammeter: for measuring current (D.C. and 3-phase A.C.)
- ④ Voltage probe: A.C. and D.C. voltages
- ⑤ Infra-red probe: for measuring temperature

Measuring device	Measurement points								
	M 01V	M 01H	M 02V	M 02H	M 02A	Shaft	E01	E02	E03
① Accelerometer	●	●	●	●	●				
② Photo-electric cell						●			
③ Clamp ammeter							●	●	●
④ Voltage probe							●	●	●
⑤ Infra-red probe	●		●						

I - SCOPE OF APPLICATION

These General Conditions of Sale ("GCS") shall apply to the sale of all products, components, software and services (referred to as "Products") proposed or sold by the Seller to the Client. Said GCS shall also apply to all quotation or offers made by the Seller, and are an integral part of all orders. "Seller" is understood to mean all companies directly or indirectly controlled by LEROY-SOMER. As a complementary measure, orders are also subject to the latest version in force of the Inter-Union General Conditions of Sale for France of the F.I.E.E.C. (*Fédération des Industries Electriques, Electroniques et de Communication* [Federation of Electrical, Electronic and Communication Industries]), inasmuch as they are not contrary to the GCS.

The acceptance of the Seller's offers or quotations, or any order, entails the acceptance without reservation of these GCS and rules out all contrary provisions shown on all other documents and, in particular, on the Client's order forms and the Client's General Conditions of Purchase.

If the sale concerns castings, by way of derogation to Paragraph 1 above, said *caveat* shall be subject to the latest version in force of the *Conditions Générales Contractuelles des Fondries Européennes* [General Contractual Conditions of European Foundries].

The Products and services sold pursuant to these GCS may under no circumstances be used for applications in the nuclear field, as such sales expressly fall under technical specifications and specific contracts that the Seller reserves the right to refuse.

II - ORDERS

All orders, even those taken by the Seller's agents and representatives, and regardless of the transmission method, shall only bind the Seller after written acceptance thereby of the order.

The Seller reserves the option of modifying the characteristics of its Products without notice. However, the Client shall retain the possibility of specifying the characteristics on which its commitment is contingent. In the absence of any such express stipulation, the Client may not refuse delivery of new, modified Products.

The Seller may not be held liable for an unsatisfactory selection of Products if said selection results from conditions of use that are incomplete and/or mistaken, or not disclosed to the Seller by the Client. Except in the event of a stipulation to the contrary, the offers and quotations remitted by the Seller shall only be valid for thirty days as from the date on which they are drawn up.

Where the Products must comply with standards, specific regulations and/or be received by control and inspection agencies, the price request must be accompanied by the technical specification, all terms and conditions the Seller must comply with. Reference shall be made thereto on the quotation or offer. Approval and attendance costs shall always be borne by the Client.

III - PRICES

Tariffs are expressed exclusive of tax and may be revised without notice.

Prices are either deemed to be firm for the period of validity specified on the quotation, or subject to a revision formula attached to the offer and which specifies, according to the regulations, parameters pertaining to the materials, products, various services and salaries for which the indices are published in the B.O.C.C.R.F. (*Bulletin Officiel de la Concurrence, de la Consommation et de la Répression des Fraudes* [French Official Journal of Competition and Consumer Matters, and Anti-Fraud Measures]).

All additional costs, in particular approval costs, specific checks, etc., shall be invoiced in addition.

IV - DELIVERY

Sales are governed by the latest edition in force of the INCOTERMS published by the Internal Chamber of Commerce ("I.C.C. INCOTERMS").

The Products shall be dispatched according to the conditions stated on the order acknowledgement issued by the Seller for all orders of Products.

Except in the event of specific provisions, the prices correspond to Products that are made available in the Seller's factories, including basic packaging.

Except in the event of a provision to the contrary, the Products shall always be transported at the risk of the addressee. In all cases, it shall be the responsibility of the addressee to make any claims to the carrier, within the delivery time and in the forms specified by law, concerning the state or number of parcels received, and to concomitantly provide the Seller with a copy of such declaration. Failure to comply with said procedure shall exempt the Seller from any liability. In any event, the Seller's liability may not exceed the amount of the indemnities received from its insurers.

If the provisions concerning transportation are amended by the Client subsequent to the acceptance of the order, the Seller reserves the right to invoice any supplemental costs that may result therefrom.

Except in the event of a contractual or statutory obligation to the contrary, packaging shall not be returnable.

In the event that a delivery of Products is delayed for a reason not attributable to the Seller, the Products stored on the Seller's premises shall be insured at the exclusive risk of the Client. Consideration for storage, costs will be invoiced at a rate of 1% (*one per cent*) of the total amount of the order, per week or partial week of storage, with no deductible or *de minimis* amount, as from the date of Products availability provided for in the contract. Upon expiration of a period of thirty days as from said date, the Seller may, at its discretion, either freely dispose of the Products and/or agree with the Client on a new delivery date for said Products, or invoice the Client in full for payment, according to the timetables and amount provided for contractually. In any event, down payments shall inure to the Seller as indemnities, without prejudice to any other action the Seller may take.

V - DELIVERY TIME

The Seller shall only be bound by the delivery time mentioned on its order acknowledgement. Said delivery time shall only start to run as from the date of issuance of the order acknowledgement by the Seller, and subject to the fulfilment of the conditions provided for on the confirmation receipt, in particular receipt of the down payment for the order, notification of the opening of an operative irrevocable and confirmed documentary credit that complies in all respects to the Seller's request (*in particular regarding the amount, currency, validity and licence*), acceptance of the payment conditions accompanied by the implementation of any guarantees requested, etc. Exceeding delivery time shall not grant the Client entitlement to damages and/or penalties.

Except in the event of a specific condition to the contrary, the Seller reserves the right to make partial deliveries.

Delivery times shall be interrupted by right and without the need for any judicial formalities, by any failure to pay or late payment by the Client.

VI - TESTS - QUALIFICATION

The Products manufactured by the Seller are checked and tested before leaving its factories. Clients may be present at said tests if specified on the order.

Specific tests and/or trials, as well as approval of Products, requested by the Client, whether carried out on the Client's premises or in the Seller's factories, on site, or by control and inspection agencies, must be specified on the order and are always at Client's expense.

Prototypes for Products specially developed or adapted for a Client must be qualified by the Client before serial production in order to ensure that it is compatible with the other components that make up its equipment, and that it is adapted to the intended use. Said qualification will also enable the Client to ensure that the Products comply with the technical specification. In this respect, the Client and Seller shall sign a Product Approval Form in two original, one of which shall be retained by the Client and one by the Seller.

In the event that the Client requires delivery without having firstly qualified the Products, said Products shall be delivered as they stand and shall always be deemed to be prototypes; the Client shall then be solely liable for using the Products or delivering them to its own clients. However, the Seller may also decide not to deliver the Products that have not received the Client's prior approval.

VII - PAYMENT CONDITIONS

All sales shall be deemed to be completed and payable at the Seller's registered office, without any possible derogation, regardless of the payment method, where the contract was concluded and where delivery was made.

Where the Client is located out of French territory, invoices shall be payable in cash upon receipt, or by a bank draft or a bill of exchange, within 30 (thirty) days net.

All early payment compared to the deadline fixed shall give right to a discount of 0,2% (*nought point two per cent*) per month, of the amount concerned of the invoice.

Except in the event of provisions to the contrary, where the Client is located outside of French Territory, invoices shall be payable in cash against remittance of shipping documents, or by irrevocable documentary credit confirmed by a first rate French bank, at Client's expense.

Payment shall be understood to mean the funds being made available on the Seller's bank account and must imperatively be made in the invoicing currency.

Pursuant to French Law no. 2001-420 of 15 May 2001, failure to pay an invoice when due shall trigger, after service of formal notice that has remained without effect, payment to the Seller of a flat-rate penalty on the due date of the receivable, which shall be applied to amount inclusive of tax of monies owed if the invoice is liable to VAT (*Value Added Tax*), and the suspension of pending orders. Said penalty is equal to the European Central Bank Rate + 7 basis points.

The collection of said monies via litigation shall trigger an increase of 15% (*fifteen per cent*) of the amount claimed, with a minimum of Euros 500 exclusive of tax (*five hundred euros exclusive of tax*), with tax in addition if due.

Moreover, subject to compliance with the statutory provisions in force, in the event of total or partial failure to pay any invoice or instalment whatsoever, regardless of the payment method used, all amounts that remain owed to the Seller (*including its subsidiaries, affiliated or allied companies, whether French or foreign*) for all deliveries and services, regardless of the due date originally provided for, shall immediately become due.

Notwithstanding any specific payment conditions provided for between the parties, the Seller reserves the right to require, in the event of a decline in the Client's credit rating, a payment incident or bankruptcy of the Client :

- the payment in cash, before the Products leave the factory, for all orders currently being fulfilled,
- down payments to be made on all orders,
- alternative or different payment guarantees.

VIII - PAYABLE AND RECEIVABLE BALANCE

Except where prohibited by law, the Seller and the Client expressly agree to balance their payables and receivables arising from their trade relations, even if all conditions defined by law for legal balancing are not met.

For the application of said clause, the Seller shall mean any company of the LEROY-SOMER Group.

IX - TRANSFER OF RISK / RESERVE OF TITLE

Risk shall be transferred as soon as the Products are made available, according to the delivery conditions stipulated on the order acknowledgement.

The transfer to the Client of title shall take place after payment in full. In the event that the restitution of the Products delivered is claimed by the Seller, the Seller is entitled to retain any down payment as compensation.

Remittance of a bill that creates an obligation to pay (*bill of exchange or other*) shall not constitute payment and discharge.

For as long as the price has not been paid in full, the Client is required to inform the Seller, within twenty-four hours, of the sequestration, requisition or confiscation of the Products for the benefit of a third party, and to take all protective measures to make known the Seller's property right in the event of action by creditors, and to cause such right to be respected.

X - CONFIDENTIALITY

Each of the parties undertakes to maintain the confidentiality of all technical, trade, financial or other information received from the other party, whether orally, in writing or by any other means of communication, when any order is negotiated and/or fulfilled.

This confidentiality obligation shall apply throughout the period during which the order is fulfilled and for 5 (five) years subsequent to completion or cancellation thereof, regardless of the reasons therefor.

XI - INDUSTRIAL AND INTELLECTUAL PROPERTY

Data, studies, results, information or software, whether patentable or not obtained by the Seller when any order is fulfilled shall remain the exclusive property of the Seller.

With the exception of instruction and maintenance manuals, documents of any nature remitted to the Client shall remain the exclusive property of the Seller and must be returned to it upon request, even if the Client was invoiced for part of the cost of the study, and said documents may not be disclosed to third parties or used without the Seller's prior written agreement.

XII - CANCELLATION / TERMINATION

The Seller reserves the right to cancel or terminate immediately, at the Seller's discretion, by right and without the need for any judicial formalities, the contract in the event of failure to pay any portion whatsoever of the price, when due, or in the event of any breach of any of the Client's contractual obligations. Down payments and any amount already paid shall remain in Seller's hands in the form of indemnities, without prejudice to the Seller's right to claim damages. In the event that the contract is cancelled, the Products must be returned to the Seller immediately, regardless of where the Products are located, at Client's expense and risk, under penalty of 10% (*ten per cent*) of the value thereof, per week's delay.

XIII - WARRANTY

The Seller warrants the Products against all operating defects caused by a material or manufacturing fault, for a period of twelve months as from the date on which the Products are made available, unless a different statutory provision subsequently applies, under the conditions defined below.

The warranty may only be triggered insofar as the Products have been stored, used and maintained in accordance with the Seller's instructions and manuals. The warranty does not apply where the defect results, in particular, from :

- inadequate monitoring, maintenance or storage,
- normal wear and tear on the Products,
- servicing or modification of the Products without the Seller's prior written authorisation,
- abnormal use of the Products or use of the Products for a purpose other than that intended,
- faulty installation of the Products on the premises of the Client and/or the end user,
- failure by the Client to disclose the purpose or conditions of use of the Products,
- failure to use genuine spare parts,
- force majeure or any event that is beyond the control of the Seller.

In any case, the warranty is limited to the replacement or repair of the parts or Products deemed faulty by the Seller's technical departments. If the repair is entrusted to a third party, the repair shall only be carried out once the Seller has agreed to the quotation for the repair.

All Products returns must have been given the Seller's prior, written authorisation.

The Products to be repaired must be dispatched carriage paid, to the address given by the Seller. If the Products are not accepted under warranty, their return to the Client shall be invoiced to the Client or the end user.

This warranty shall apply to the Seller's Products that are made readily available and therefore does not cover the de-installation and re-installation of said Products in the equipment into which it is mounted.

Repair, modification or replacement of any part or Product during the warranty period may not result in the warranty period being extended.

The provisions of this article constitute the Seller's sole obligation concerning the warranty of the Products delivered.

XIV - LIABILITY

The Seller's liability is strictly limited to the obligations stipulated in these GCS and those expressly accepted by the Seller. All penalties and indemnities provided for therein constitute lump sum damages that include discharge for the Seller and are exclusive of any other penalty or indemnification.

With the exception of the Seller's gross negligence and the compensation of bodily injury, the Seller's liability shall be limited, in total, to the contractual amount, exclusive of tax, of the Product(s) that give(s) right to compensation.

The Seller may under no circumstances be required to indemnify consequential, indirect and / or punitive damages that the Client may use as the basis for a claim; as a result, the Seller may not be required to indemnify, in particular, production losses, operating losses or lost profit or, in general, any damage eligible for indemnification other than bodily injury or damage to property.

The Client undertakes to hold harmless the Seller and / or its insurers from any and all claims made by its insurers and/or any third party in a contractual relation with the Client, in excess of the limit and for the exclusions listed above.

XV - SPARE PARTS AND ACCESSORIES

Spare parts and accessories shall be supplied upon request, to the extent of their availability. Associated costs shall be invoiced in addition.

The Seller reserves the right to require a minimum quantity or invoicing amount per order.

XVI - WASTE MANAGEMENT

The Products that form the purpose of the sale does not fall within the scope of the European Directive 2002/96/EC (WEEE) dated January 27th, 2003, and all related legislation of Member States of the European Union that result therefrom, on the composition of electrical and electronic equipment and the disposal of waste from such equipment.

In accordance with Article L 541-2 of the French Environment Code, it is the responsibility of the waste holder to ensure the disposal thereof or to cause the disposal thereof at its own expense.

XVII - FORCE MAJEURE

With the exception of the Client's obligation to pay the monies owed to the Seller in respect of an order, the Client and Seller may not be held liable for the total or partial failure to perform their contractual obligations if such failure results from the occurrence of a force majeure. Delays or disturbances in production that totally or partially result from war (whether declared or not), terrorist act, strikes, riots, accidents, fires, floods, natural disasters, transportation delays, shortage of components or materials, governmental decision or action (including prohibition on import/export or the withdrawal of an import/export licence) shall, in particular, be deemed a force majeure.

If one of the parties is delayed or prevented from performing its obligations by reason of this Article for a period in excess of 180 consecutive days, each party may then terminate, by right and without any need for judicial formalities, the unperformed part of the order, by written notice to the other party, without liability. However, the Client shall be required to pay the price agreed pertaining to the Products already delivered on the date of termination.

XVIII - PROHIBITION ON UNLAWFUL PAYMENTS

The Client shall refrain from being engaged in any activity that would expose the Seller or any of its affiliates to a risk of penalties under laws and regulations of any relevant jurisdiction prohibiting improper payments, including but not limited to bribes or gifts of an obviously unreasonable amount, to any government or agency officials, to political parties or their officials or candidates for public office, or to any employee of any customer or supplier.

XIX - TRADE COMPLIANCE LAWS

The Client agrees that all applicable import, export control and sanctions laws, regulations, orders and requirements, as they may be amended from time to time, including without limitation those of the European Union, the United States of America, and the jurisdictions in which the Seller and the Client are established or from which Products may be supplied, and the requirements of any licences, authorisations, general licences or licence exceptions relating thereto ("Trade Compliance Laws") will apply to its receipt and use of Products, as well as related services and technology. In no event shall the Client use, transfer, release, export or re-export the Products, related services or technology in violation of Trade Compliance Laws.

Seller shall have no obligation to supply any Products, or services unless and until it has received any necessary licences or authorisations or has qualified for general licences or licence exceptions under Trade Compliance Laws.

If for any reason any such licences, authorisations or approvals are denied or revoked, or if there is a change in any Trade Compliance Laws that would prohibit Seller from fulfilling the contract, or would in the reasonable judgement of Seller otherwise expose Seller and/or Seller's Affiliate(s) to a risk of liability under Trade Compliance Laws, Seller shall be relieved without liability of all obligations under the contract.

XX - SEVERABILITY

All clauses and/or provisions of these General Conditions that are deemed or become null or void shall not cause the nullity or voidance of the contract, but solely the clause and/or provision concerned.

XXI - DISPUTES

THIS CONTRACT SHALL BE GOVERNED BY AND INTERPRETED IN ACCORDANCE WITH THE LAWS OF FRANCE.

ANY DISPUTE IN RELATION TO THE INTERPRETATION OR THE EXECUTION OF THIS CONTRACT NOT AMICABLY SETTLED BETWEEN THE PARTIES WITHIN A 30 DAY PERIOD, SHALL BE SETTLED BY THE COMPETENT COURT OF ANGOULÊME (FRANCE), EVEN IN THE CASE OF INTRODUCTION OF THIRD PARTIES OR THE INVOLVEMENT OF SEVERAL DEFENDANTS. HOWEVER, THE SUPPLIER RESERVES THE EXCLUSIVE RIGHT TO BRING THE DISPUTE TO THE COMPETENT COURTS OF THE SELLER OR THE CLIENT.



WORLD LEADER IN INDUSTRIAL DRIVE SYSTEMS

**ELECTRIC MOTORS - GEARBOXES - ELECTRONICS
ALTERNATORS - ASYNCHRONOUS GENERATORS - DC MACHINES**



**37 PRODUCTION UNITS
470 SALES & SERVICE CENTRES WORLDWIDE**



MOTEURS LEROY-SOMER 16015 ANGOULÊME CEDEX - FRANCE

338 567 258 RCS ANGOULÊME
S.A. au capital de 62 779 000 €

www.leroy-somer.com